



BHC
Acoustilog

FILE NO. _____

COMPANY E.G. & G. IDAHO, INCORPORATED

WELL RRGP-4

FIELD RAFT RIVER GEOTHERMAL

COUNTY CASSIA STATE IDAHO

LOCATION: SEC 23 TWP 15S RGE 26E

Other Services
DIFL, CDL,
4-ARM CAL,
CDL/CNLOG,
TEMP. LOG

Permanent Datum GL Elev. 4840 KB 4856

Log Measured from KB 16 Ft. Above Permanent Datum DF ---

Drilling Measured from KB GL 4840

Date	9-29-78			
Run No.	ONE			
Depth—Driller	3478			
Depth—Logger	3457			
Bottom Logged Interval	3448			
Top Logged Interval	1820			
Casing—Driller	3 3/8 @ 1820	@	@	@
Casing—Logger	1836			
Bit Size	12 1/4			
Type Fluid in Hole	WATER	@	@	@
Density and Viscosity	---	---	---	---
pH and Fluid Loss	---	cc	cc	cc
Source of Sample	FLOWLINE			
Rm @ Meas. Temp.	1.61 @ 145°F	@ °F	@ °F	@ °F
Rmf @ Meas. Temp.	---	@ °F	@ °F	@ °F
Rmc @ Meas. Temp.	---	@ °F	@ °F	@ °F
Source of Rmf and Rmc	---			
Rm @ BHT	0.94 @ 248°F	@ °F	@ °F	@ °F
Time Since Circ.	36 HOURS			
Max. Rec. Temp. Deg. F.	248 °F	°F	°F	°F
Equip. No. and Location	6110 R.S.			
Recorded By	BOS-FERRY			
Witnessed By	GOLDMAN			

THIS HEADING AND LOG CONFORMS TO API RECOMMENDED STANDARD PRACTICE RP-31

REMARKS CYCLE SKIPPING IN ZONE OF WATER FLOW.

Equipment Used		Scale Changes	
Series No.	Run No.	Scale Up Hole	Scale Down Hole
1603	ONE		
94282	---		
---	---		
---	---		
33217	---		

Equipment Data		Scale Changes	
Run No.	Tool Type	Scale Up Hole	Scale Down Hole
ONE	BHC-1603		
	CENT.		

Changes in Mud Type or Additional Samples		Type Log		Depth	
Date	Sample No.	Type Log	Depth	Scale Up Hole	Scale Down Hole

Type Fluid in Hole		Dens.		Visc.		pH		Fluid Loss	
Source of Sample	Temp.	cc	cc	cc	cc	cc	cc	cc	cc
@	°F								
@	°F								
@	°F								
@	°F								
@	°F								
@	°F								

ACOUSTILOG
T₁ 4 R₁ 2 R₂ 4 T₂

VM=18,000
VF=5300

30 20 10 0 % POROSITY

SPECIFIC ACOUSTIC TIME
Micro Seconds Per Foot

140 90 40

DEPTH

G/R & Caliper

API UNITS 150

HOLE SIZE - INCHES

7 9 11 13 15

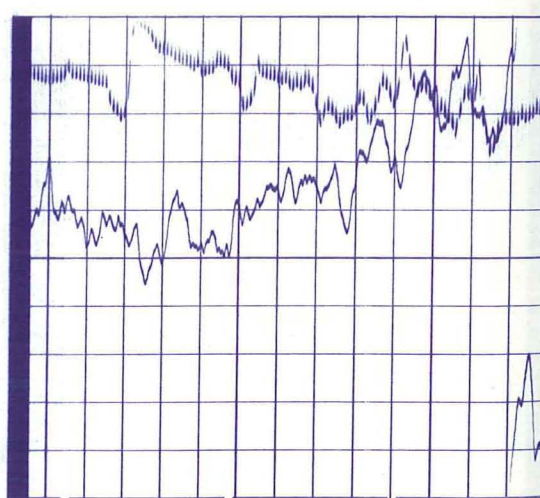
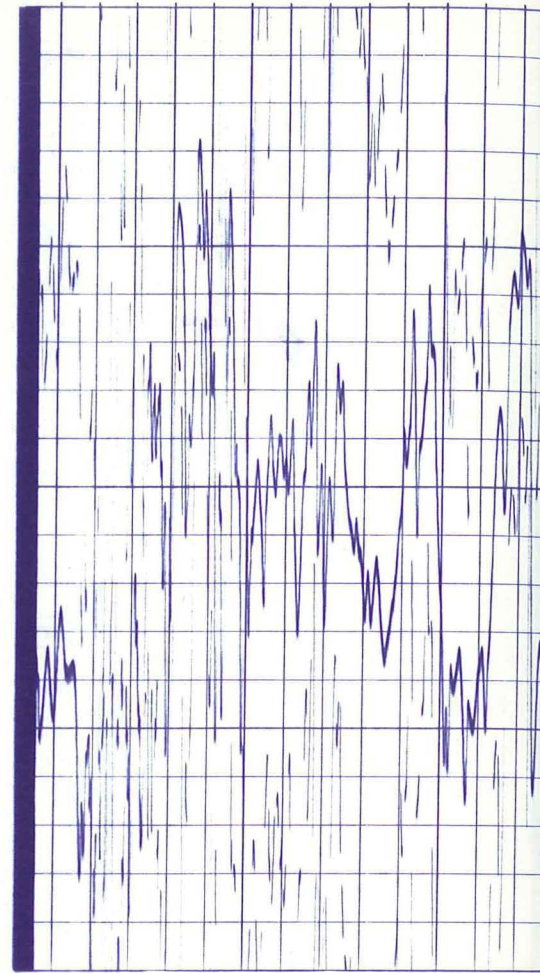

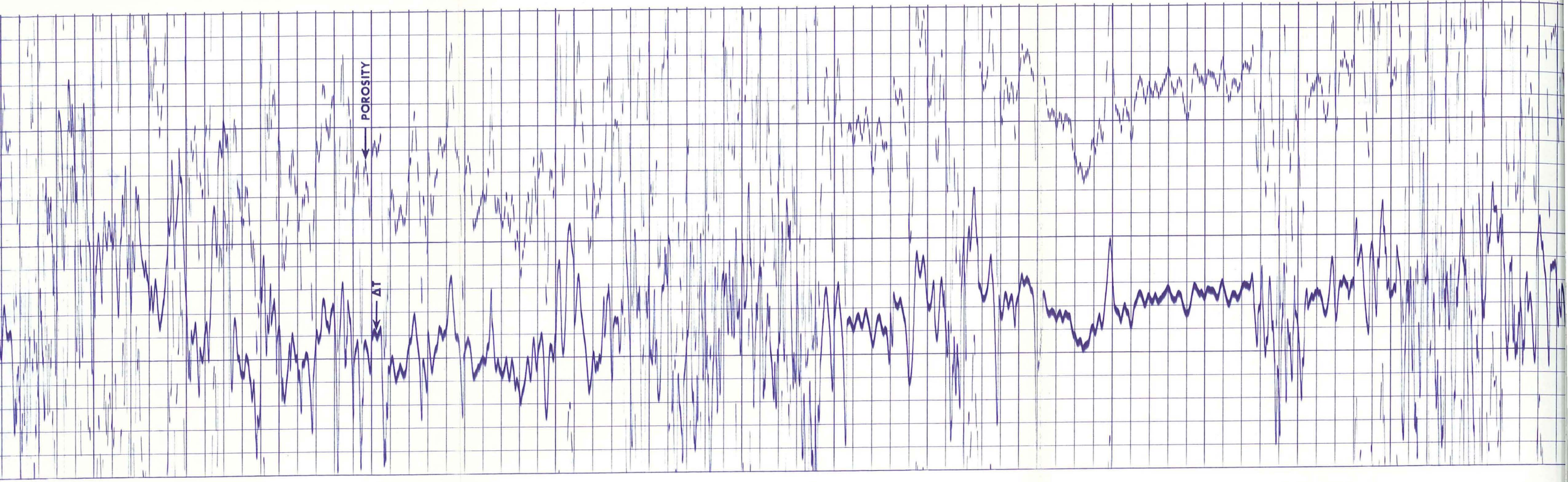

900 2000 2100 2200 2300 2400 2500 2600 2700

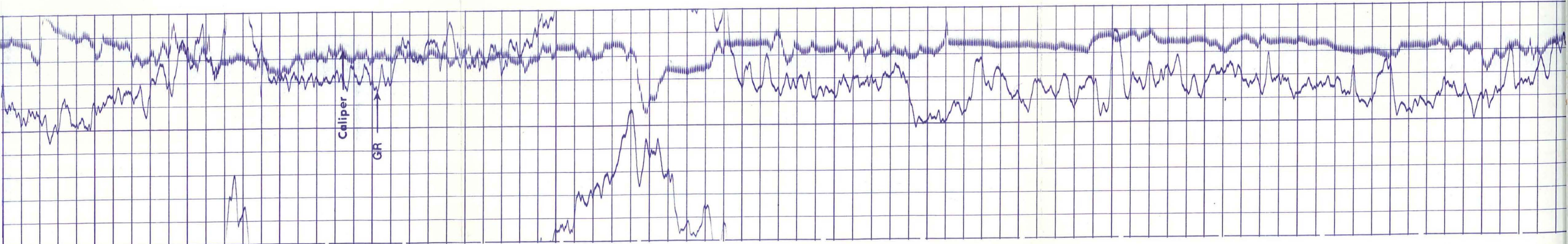

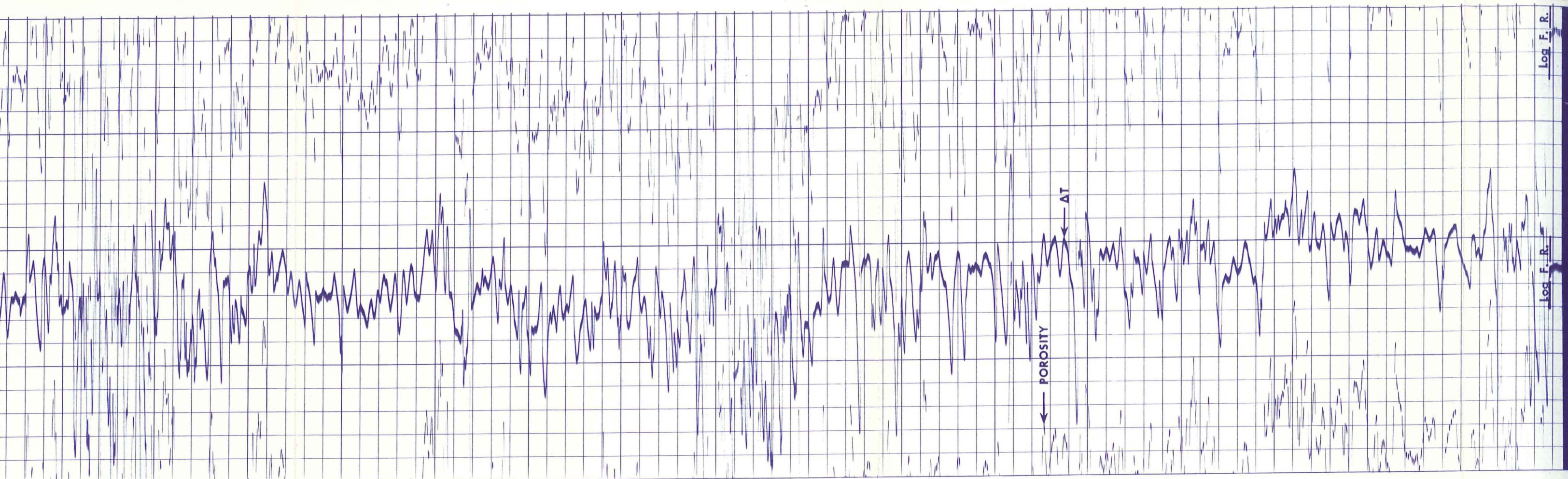

2700

2800

2900

3000

3100

3200

3300

3400

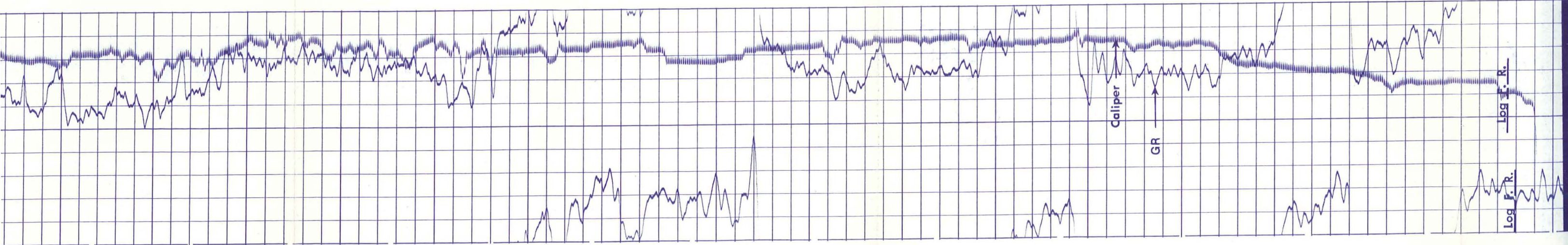

Caliper

GR

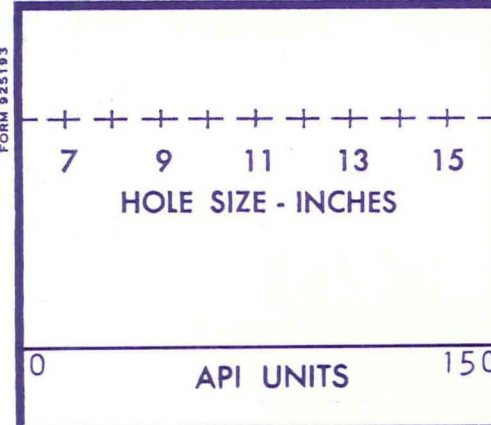
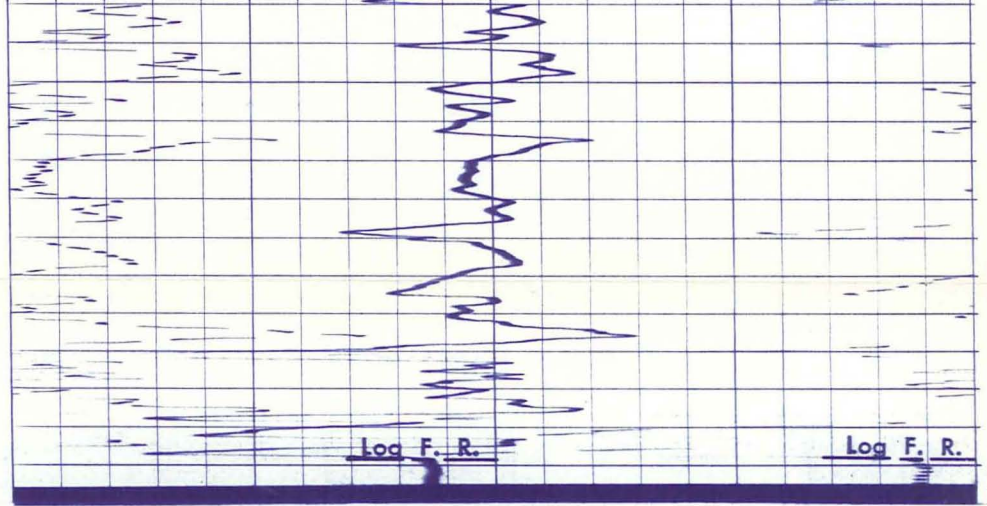
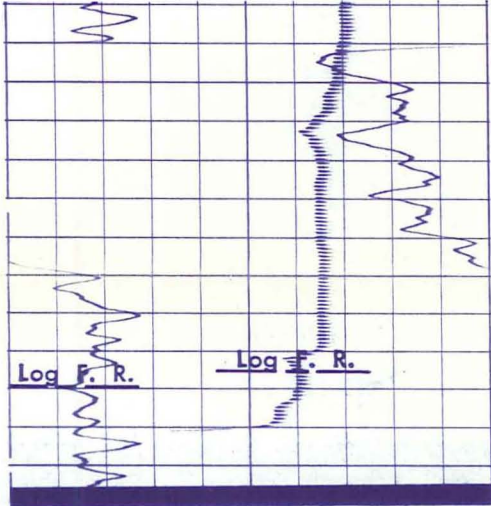

G/R & Caliper	DEPTH	ACOUSTILOG T ₁ 4 R ₁ 2 R ₂ 4 T ₂
Company E.G. & G. IDAHO, INCORPORATED	Drillers T.D. 3470	
Well RRG-4	Log F.R. 3448	
Field RAFT RIVER GEOTHERMAL	Log T.D. 3457	
County CASSIA	Elevations:	
State IDAHO	K.B. 4856	D.F. --- G.L. 4840

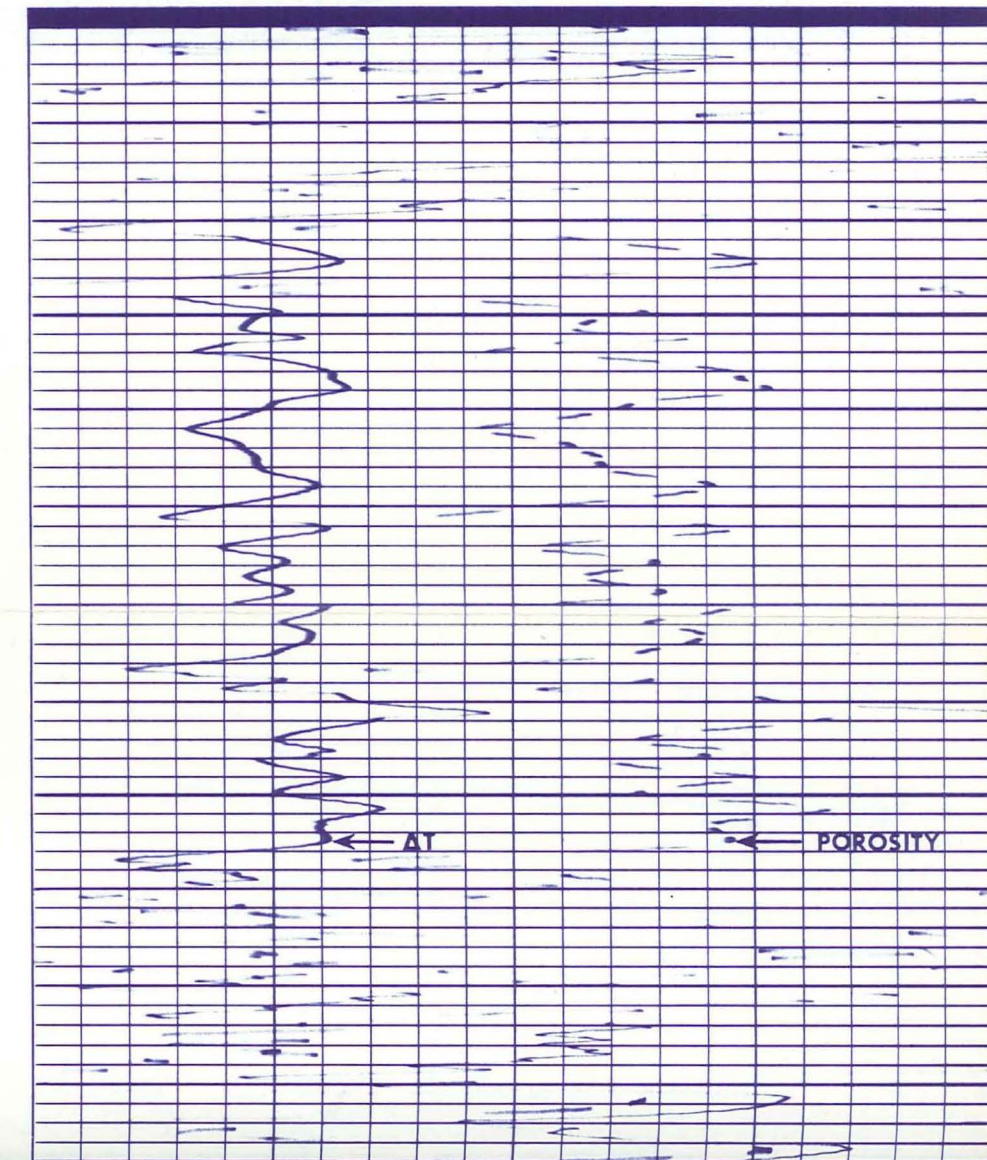
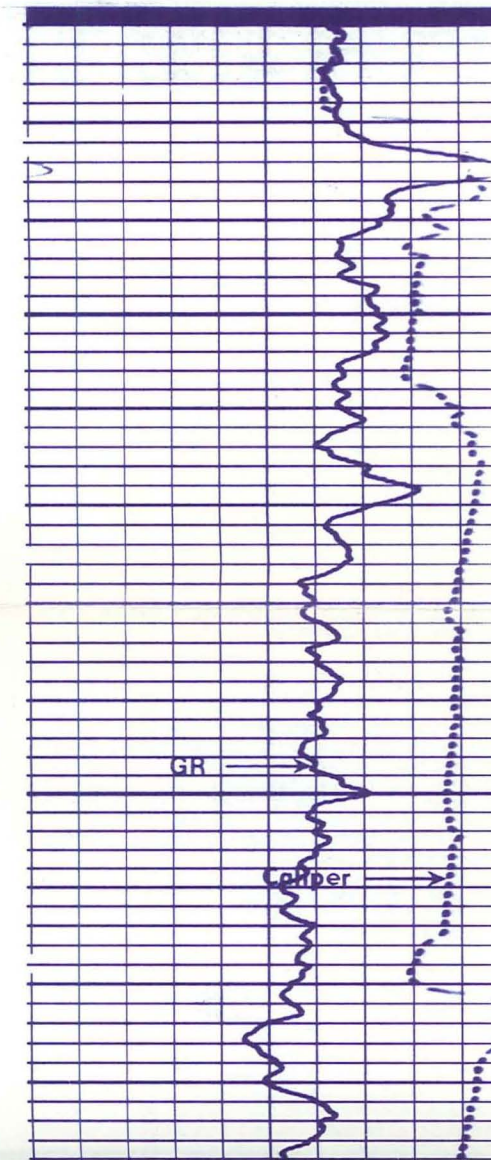
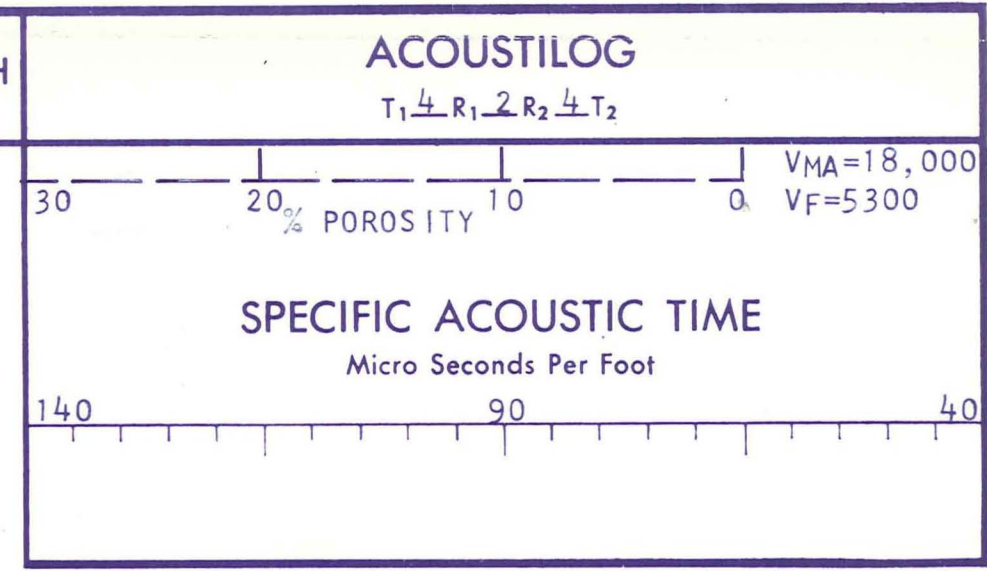
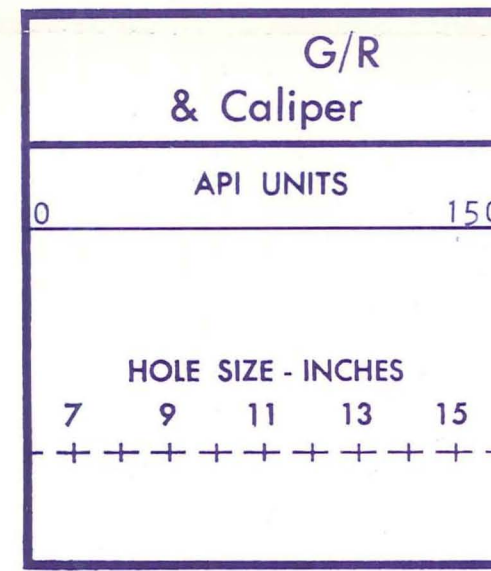

3406

1900

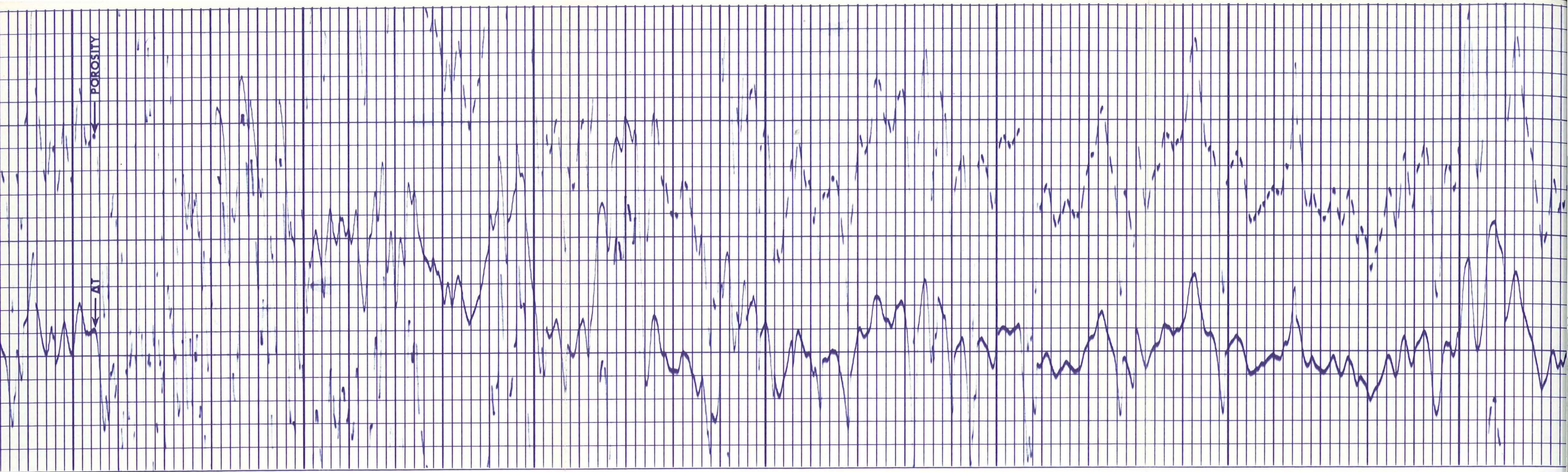

1900

2000

2100

2200

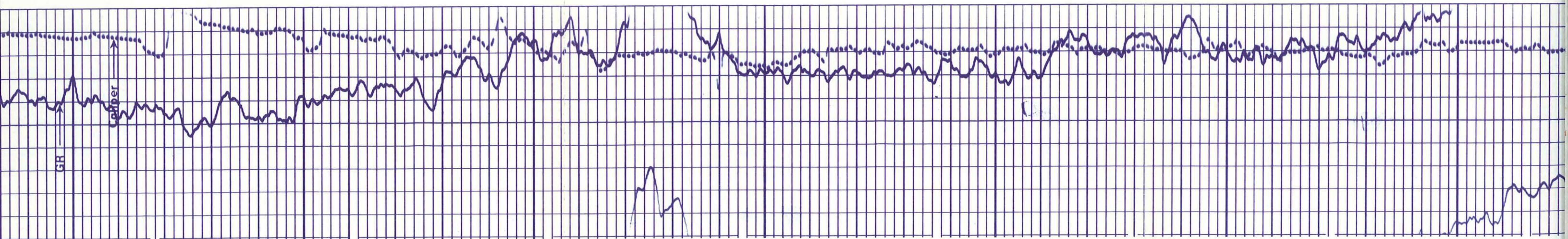



2200

2300

2400

2500

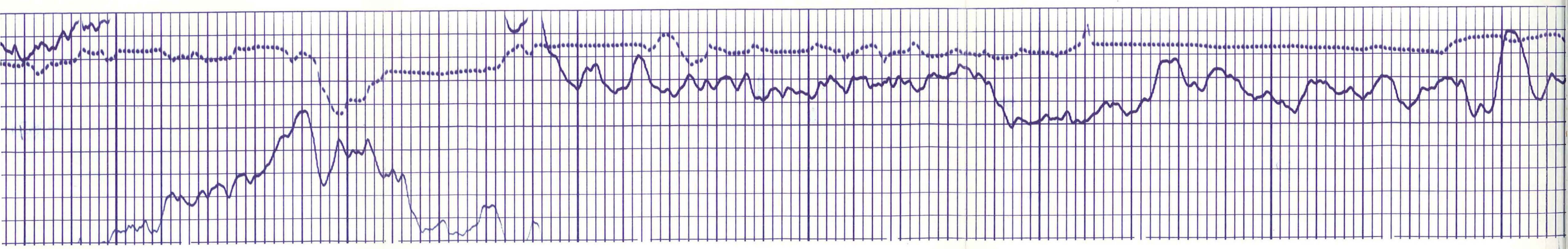

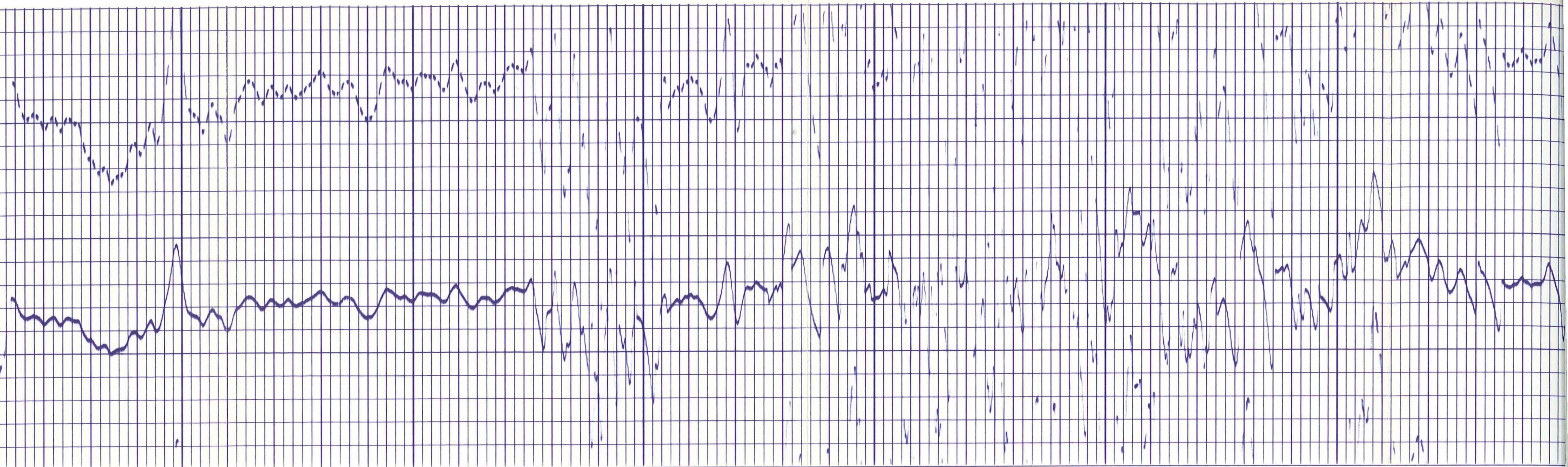

2500

2600

2700

28

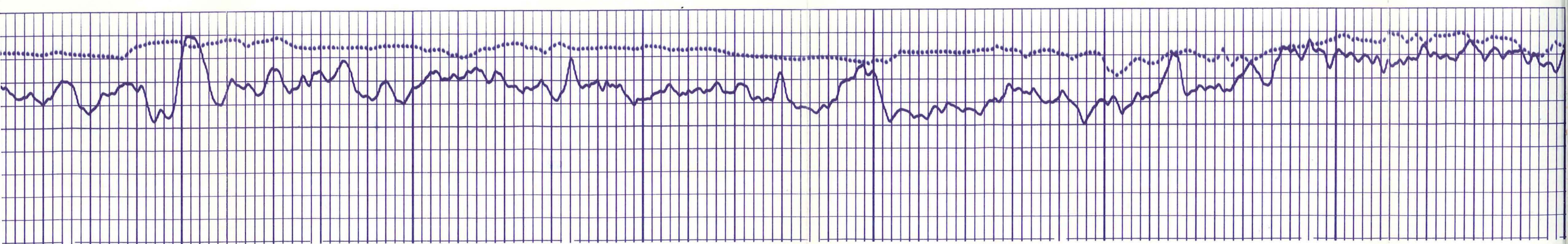

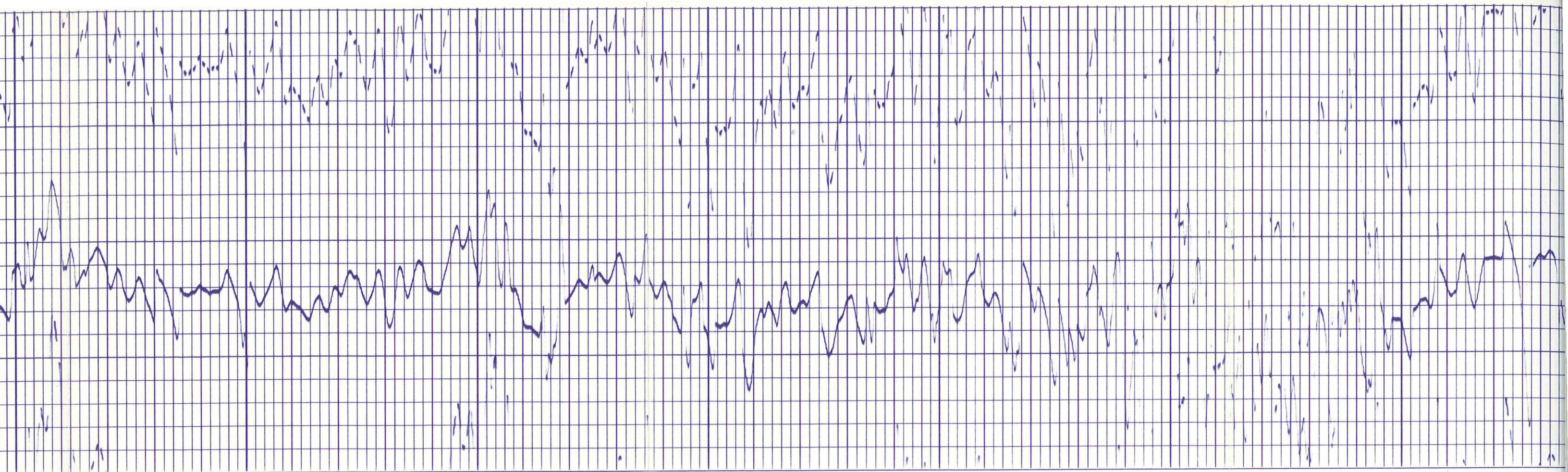

2800

2900

3000

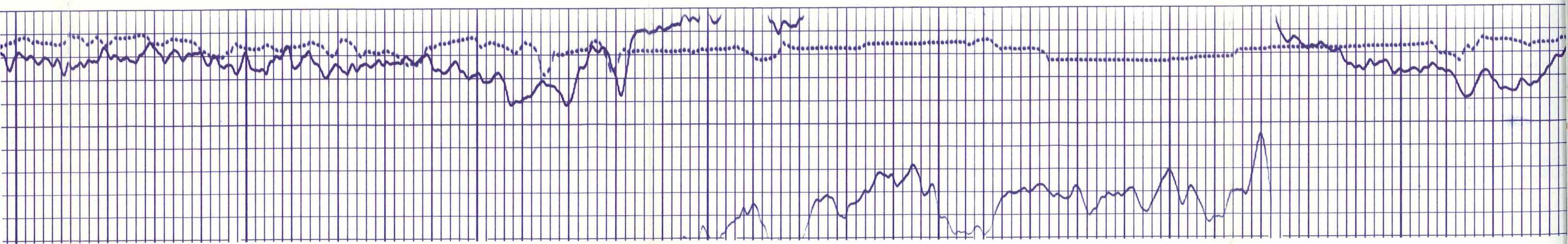

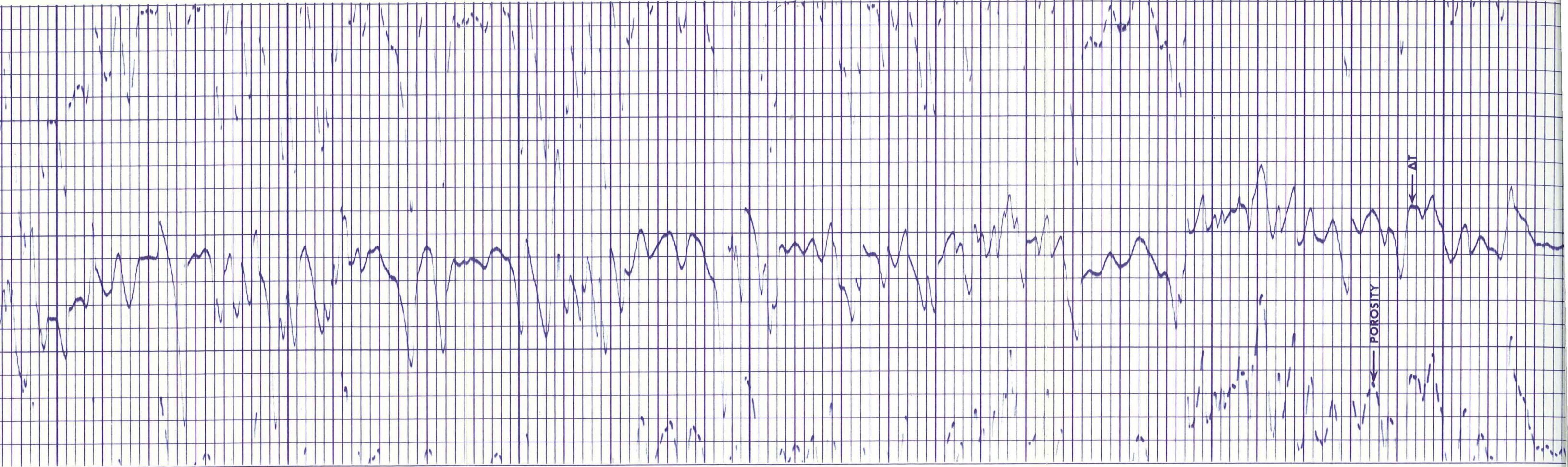

3100

3200

3300

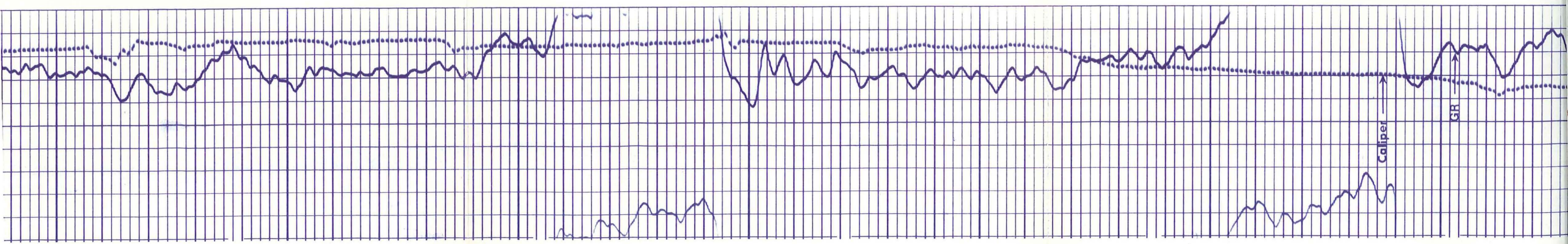

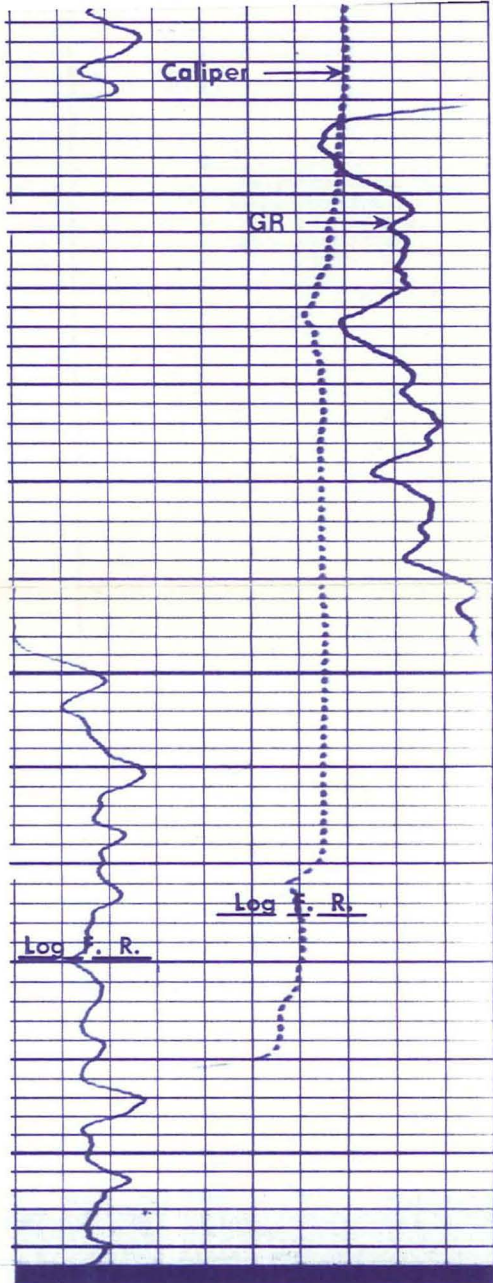

340

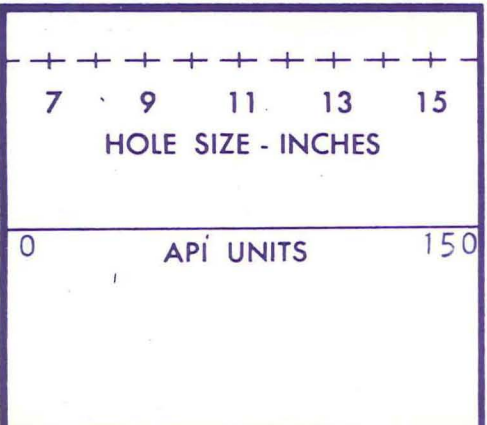
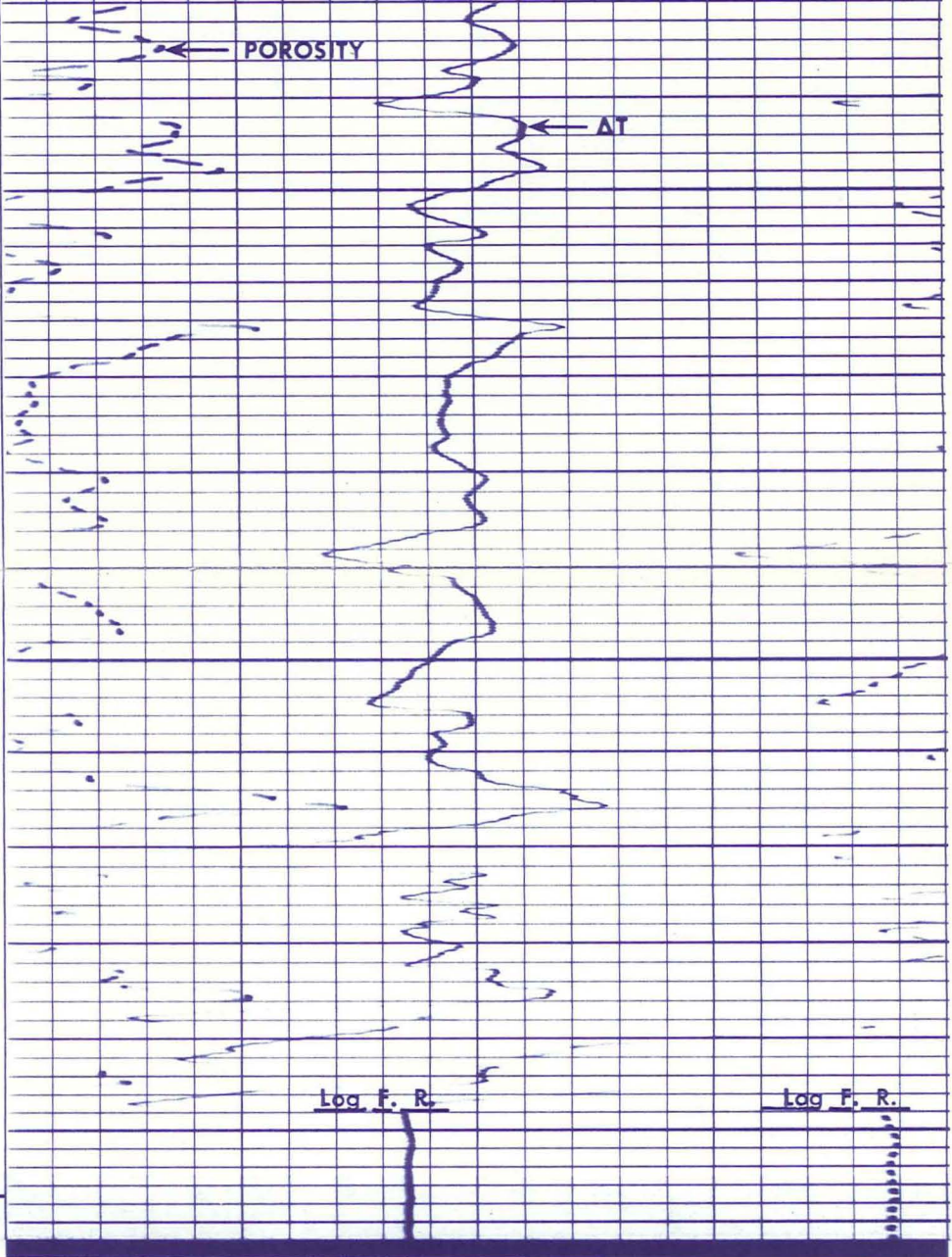

G/R & Caliper	DEPTH	ACOUSTILOG T ₁ 4 R ₁ 2 R ₂ 4 T ₂
------------------	-------	---

Company	E.G. & G. IDAHO, INCORPORATED	Drillers T.D.	3470
Well	RRGP-4	Log F.R.	3448
Field	RAFT RIVER GEOTHERMAL	Log T.D.	3457
County	CASSIA	Elevations:	
State	IDAHO	K.B. 4856	D.F. --- G.L. 4840

POROSITY DETERMINATION FROM ACOUSTILOG

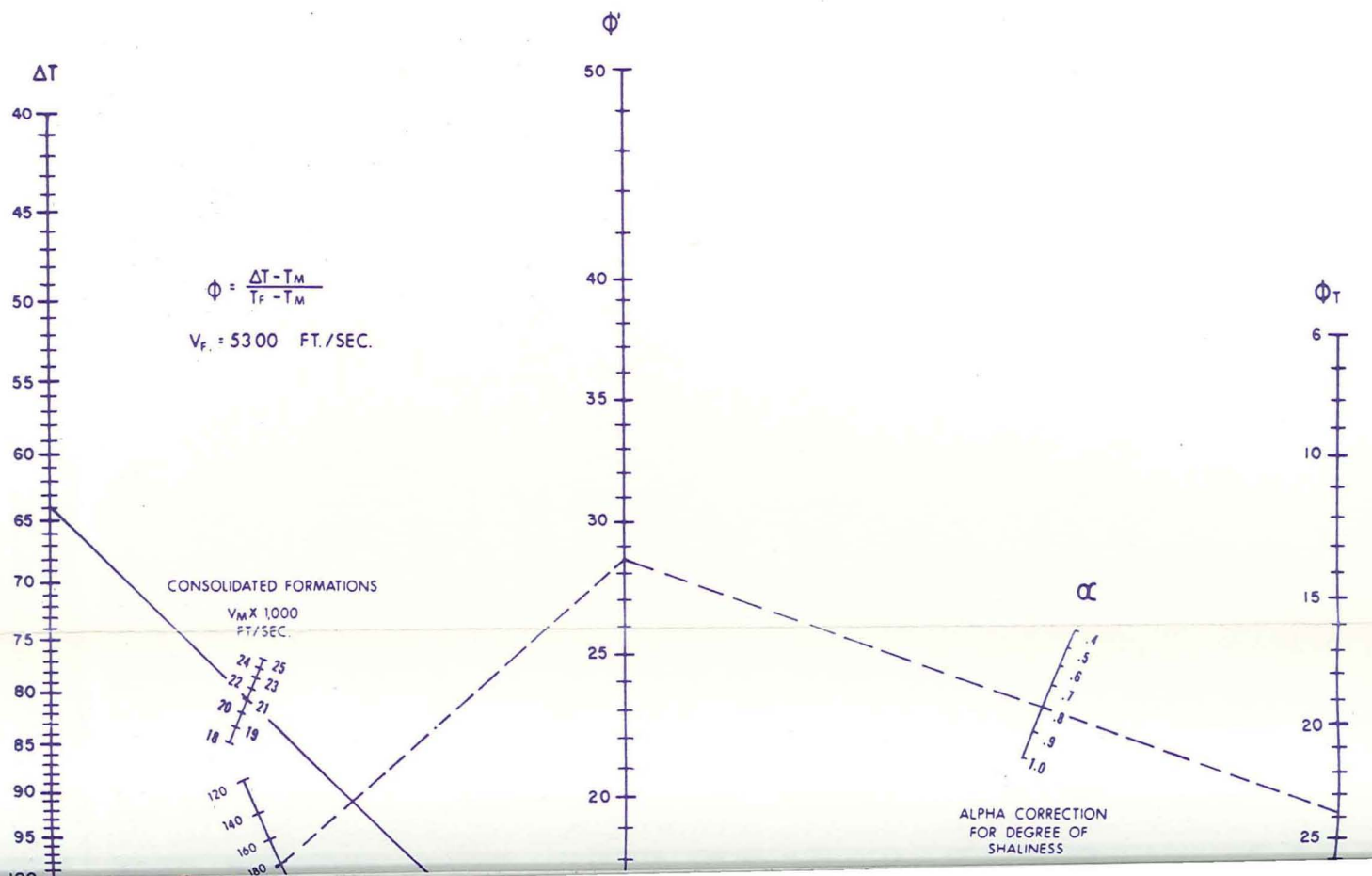

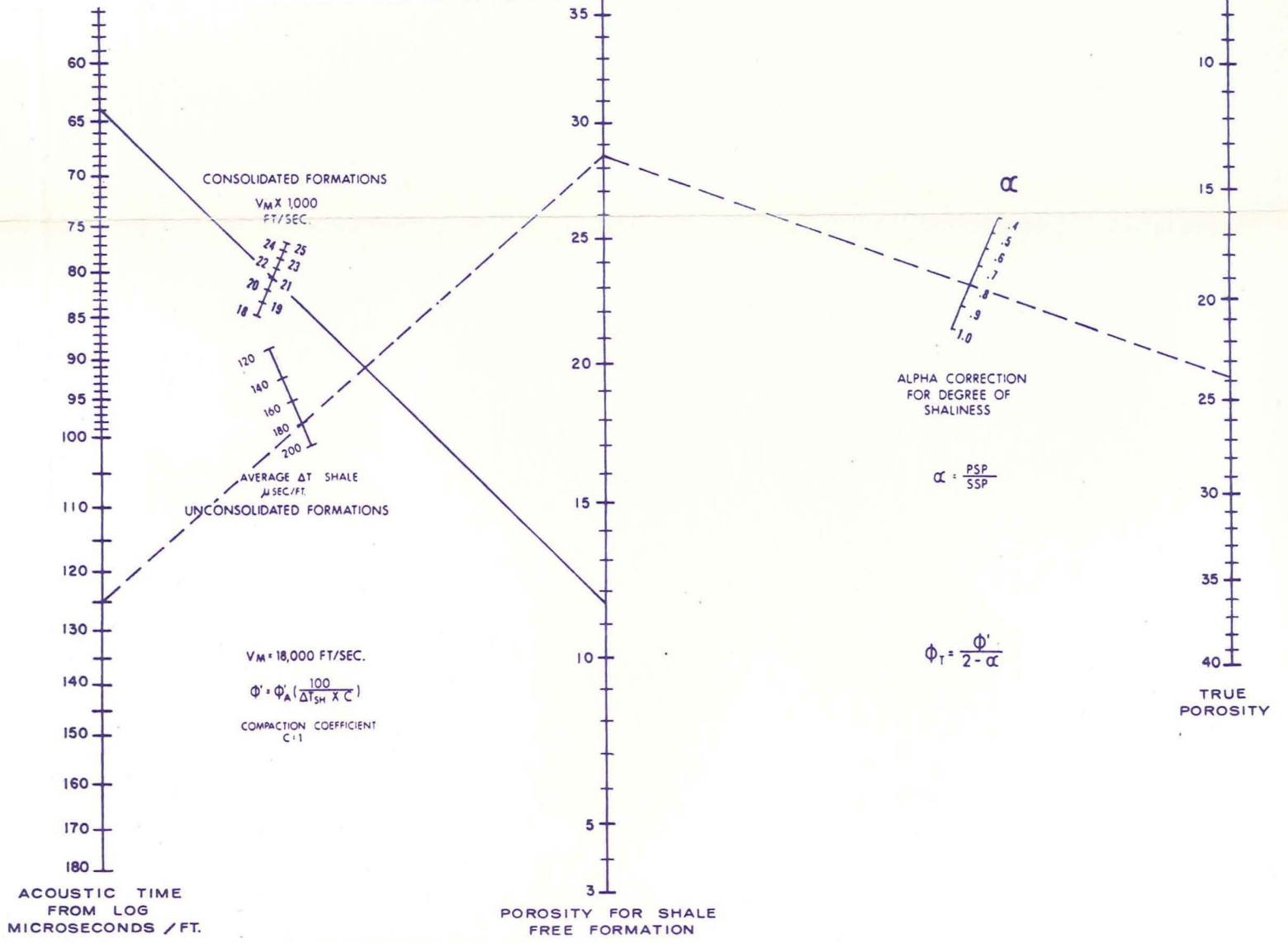

REPEAT SECTION

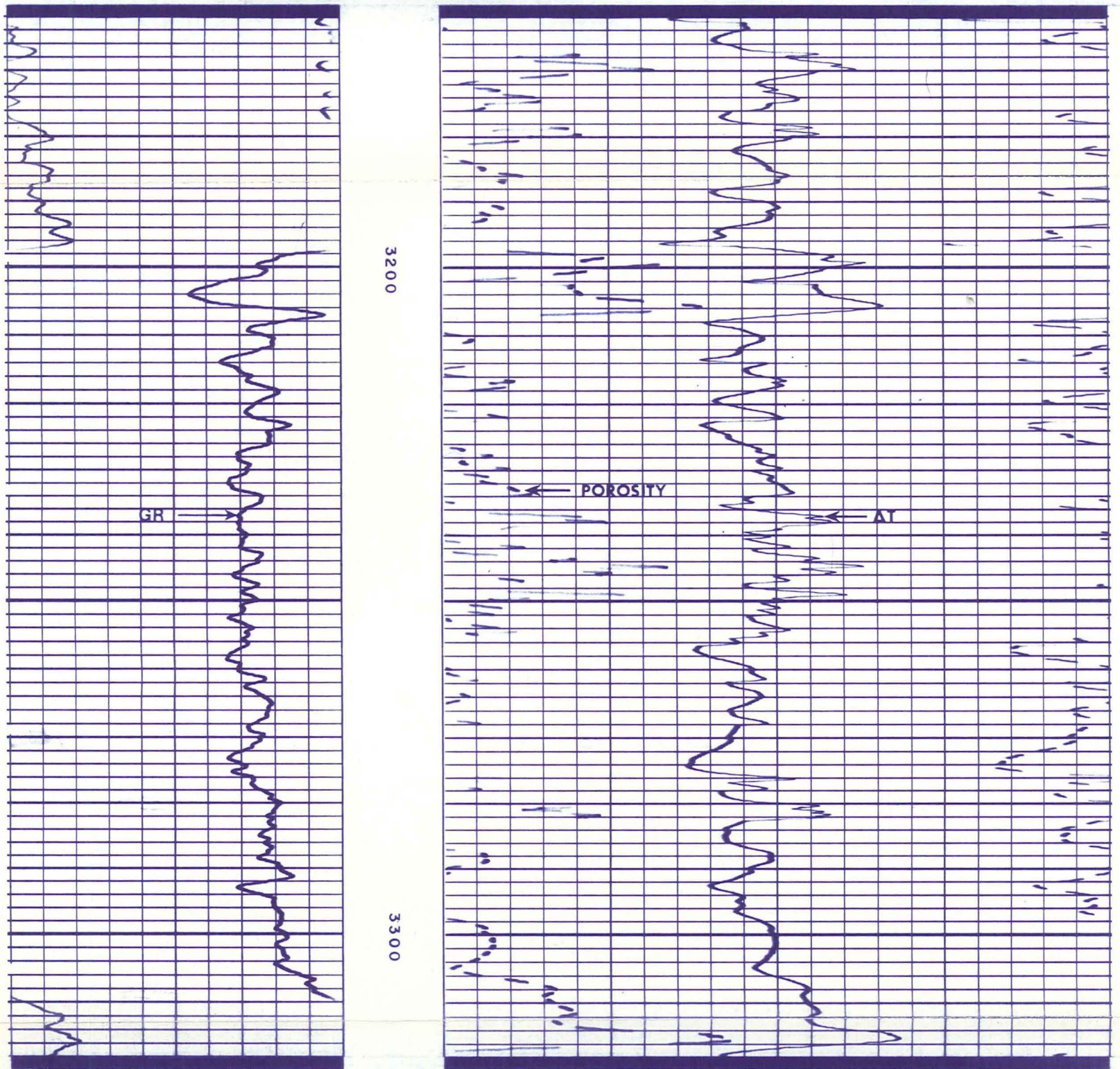

CALIBRATION - AFTER SURVEY

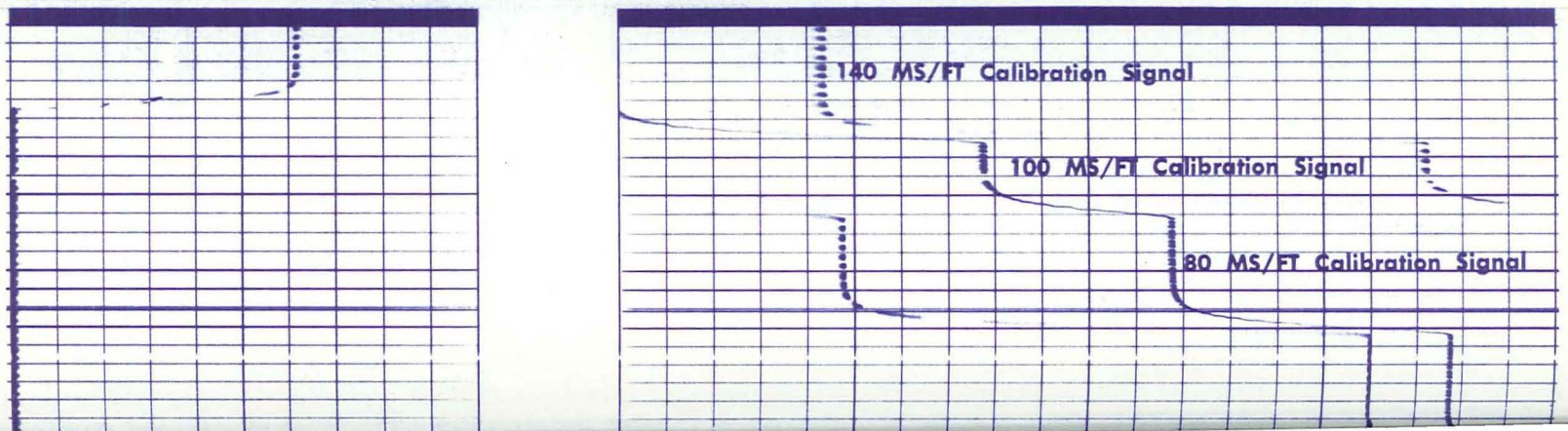

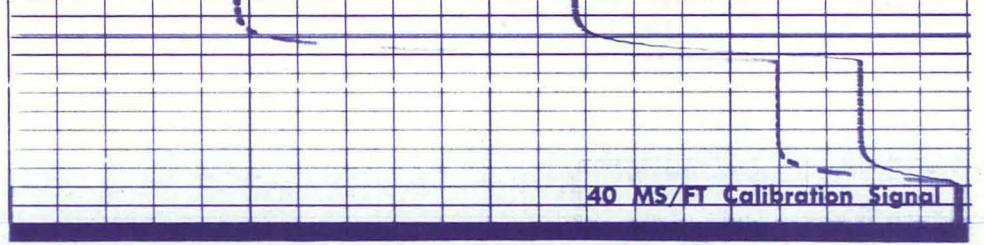
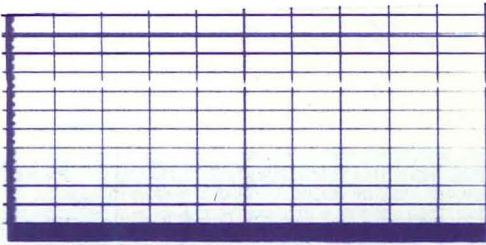

CALIBRATION - BEFORE SURVEY

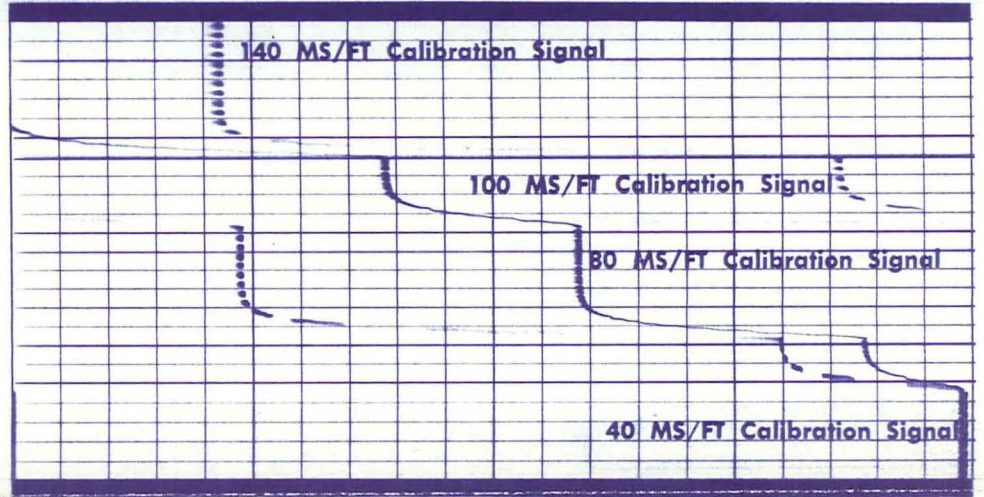
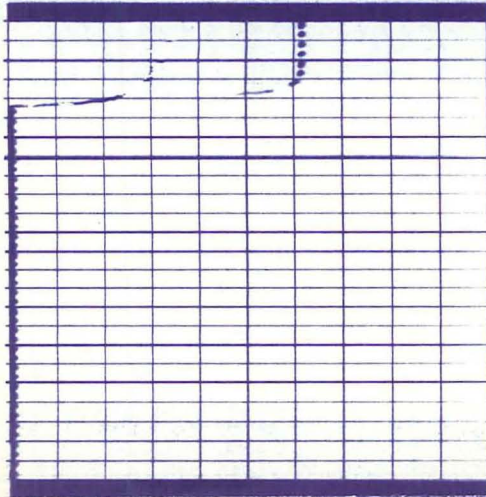

G/R LOG CALIBRATION AFTER LOG

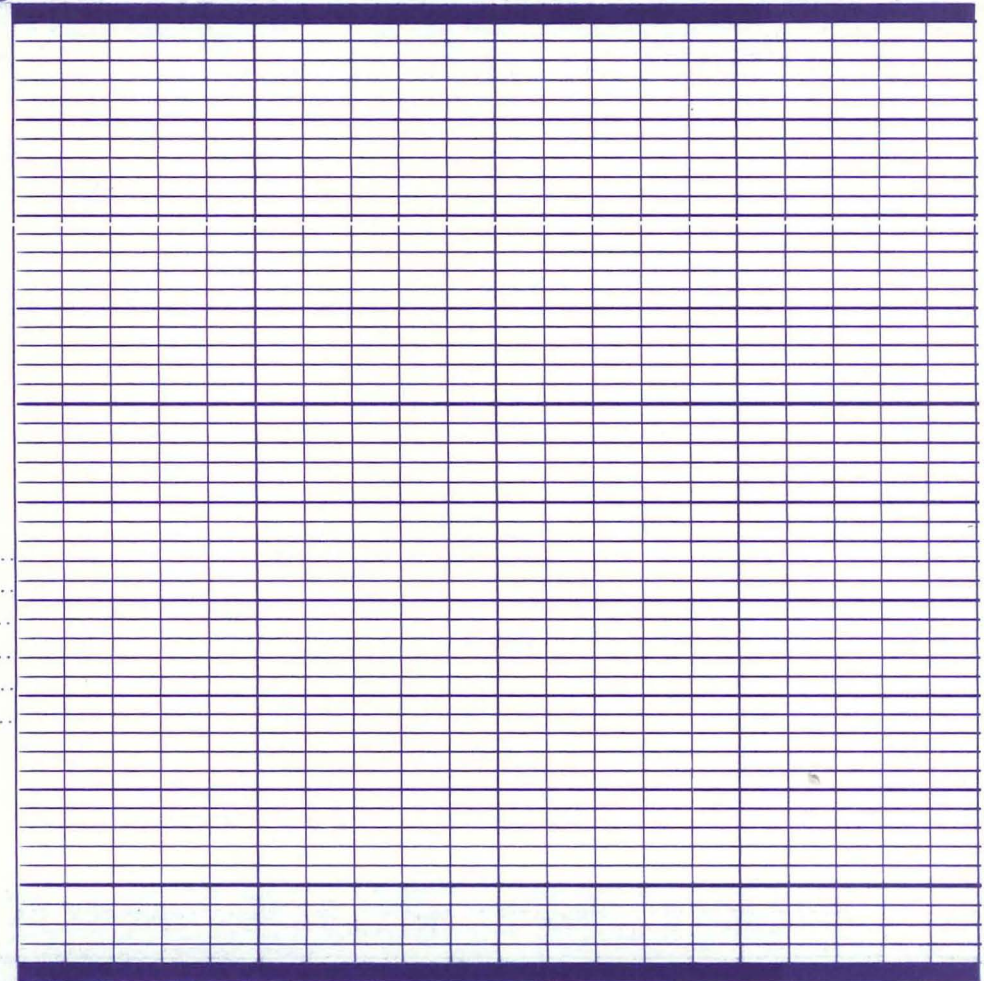
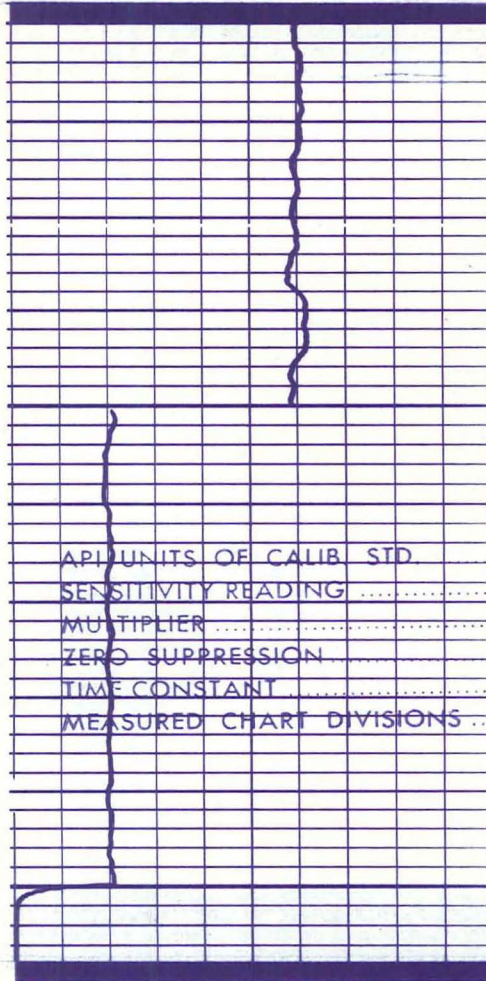

API UNITS OF CALIB STD	185
SENSITIVITY READING	200
MULTIPLIER	X1
ZERO SUPPRESSION	0
TIME CONSTANT	2
MEASURED CHART DIVISIONS	4

G/R LOG CALIBRATION BEFORE LOG

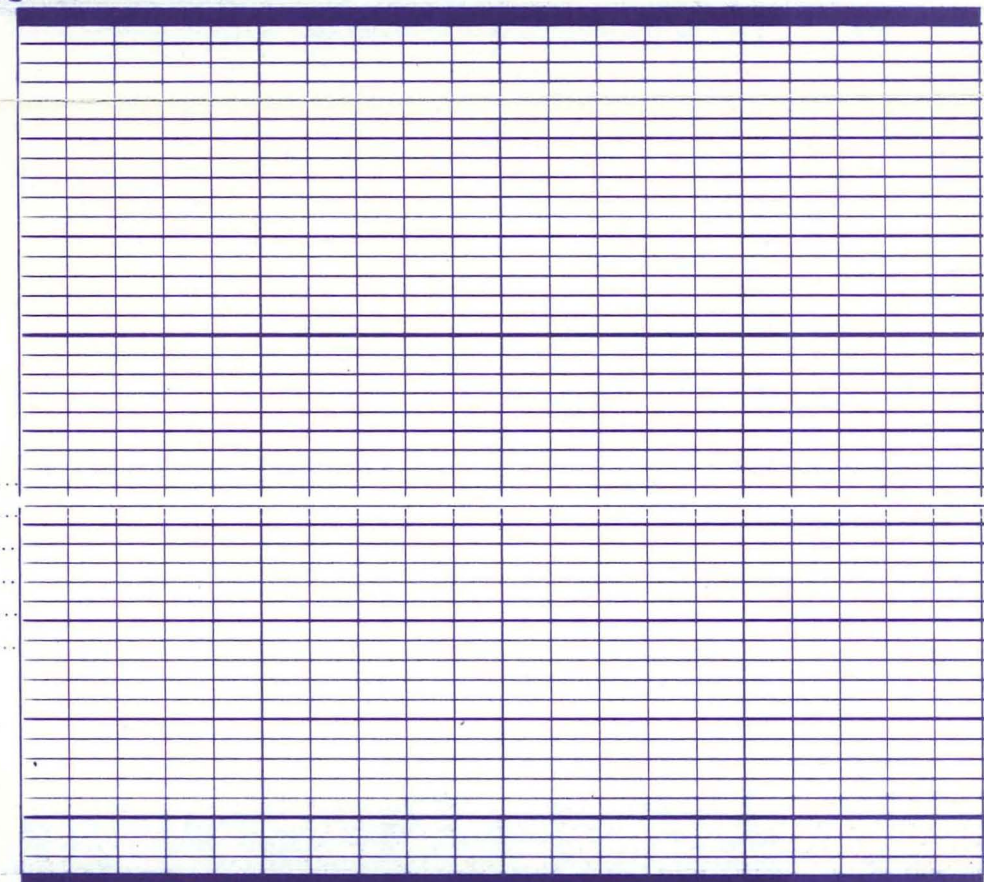
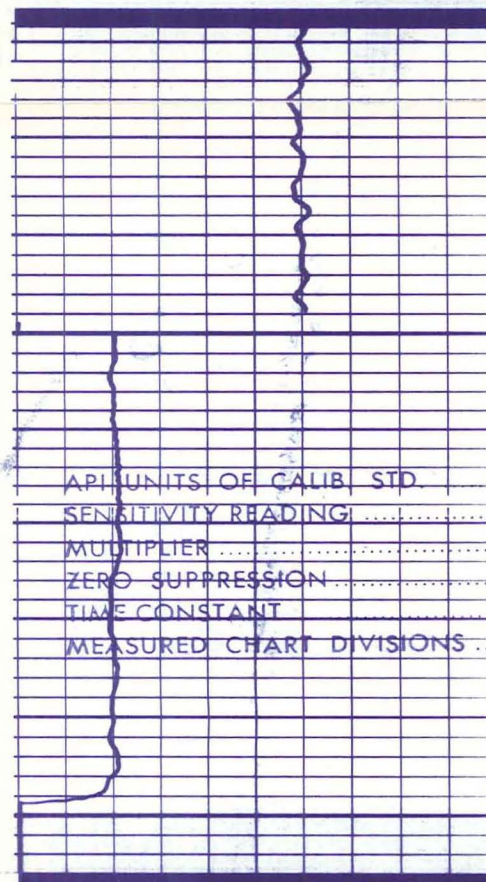

API UNITS OF CALIB STD	185
SENSITIVITY READING	200
MULTIPLIER	X1
ZERO SUPPRESSION	0
TIME CONSTANT	2
MEASURED CHART DIVISIONS	4



Division of Dresser Industries, Inc.



FILE_CAB_15_DRAWER_2

*Crack (Crack)
580'*

AFTER LOG

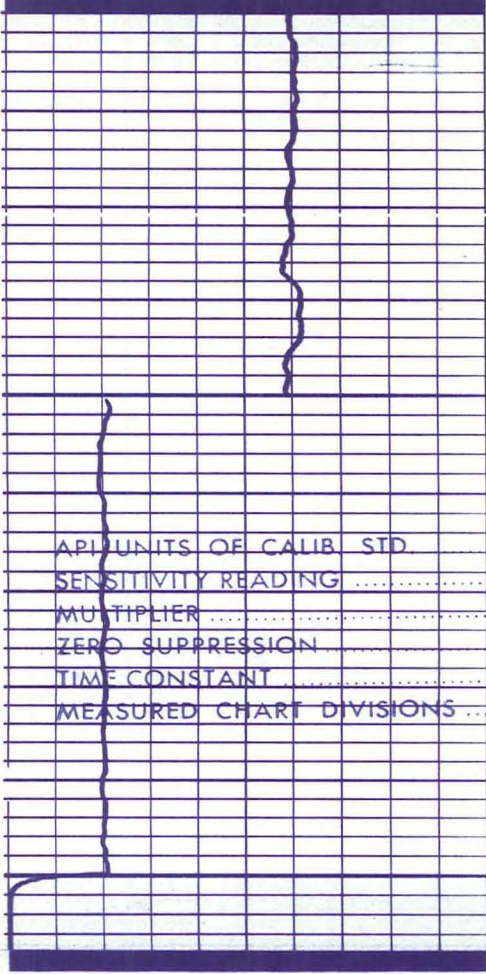

API UNITS OF CALIB STD 185
 SENSITIVITY READING 200
 MULTIPLIER X1
 ZERO SUPPRESSION 0
 TIME CONSTANT 2
 MEASURED CHART DIVISIONS 4

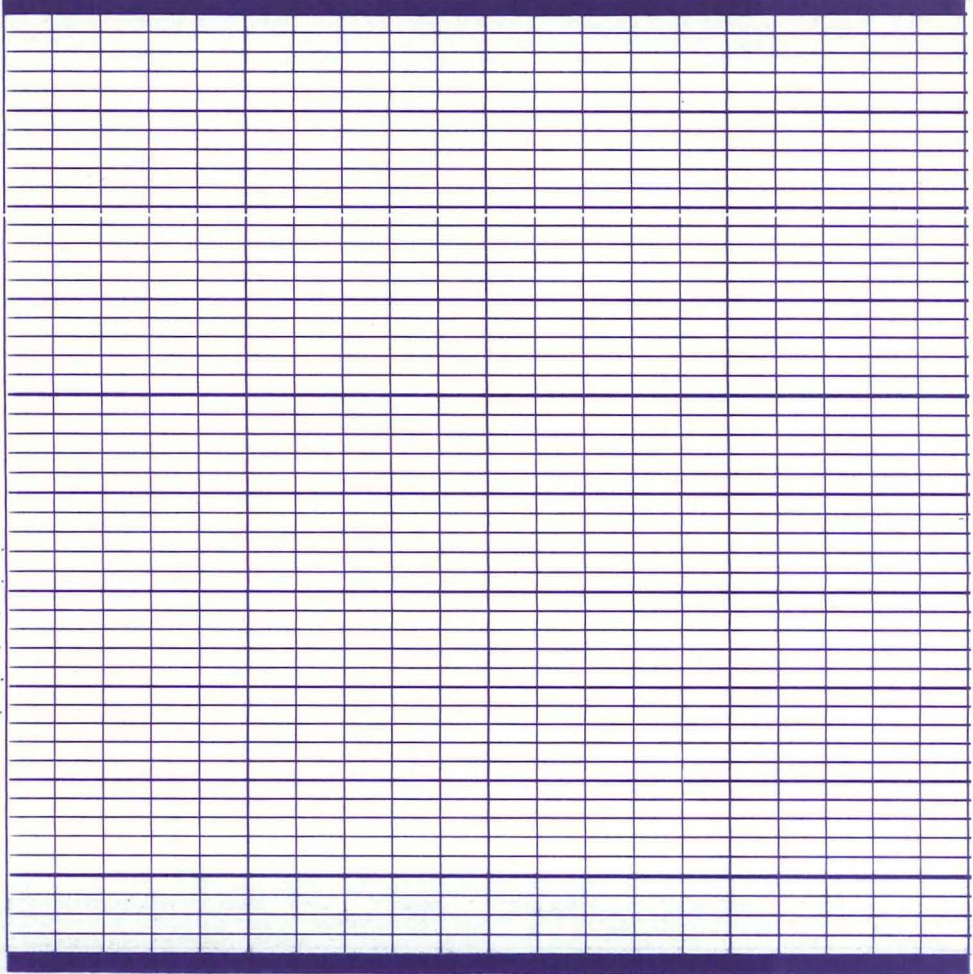

G/R LOG CALIBRATION BEFORE LOG

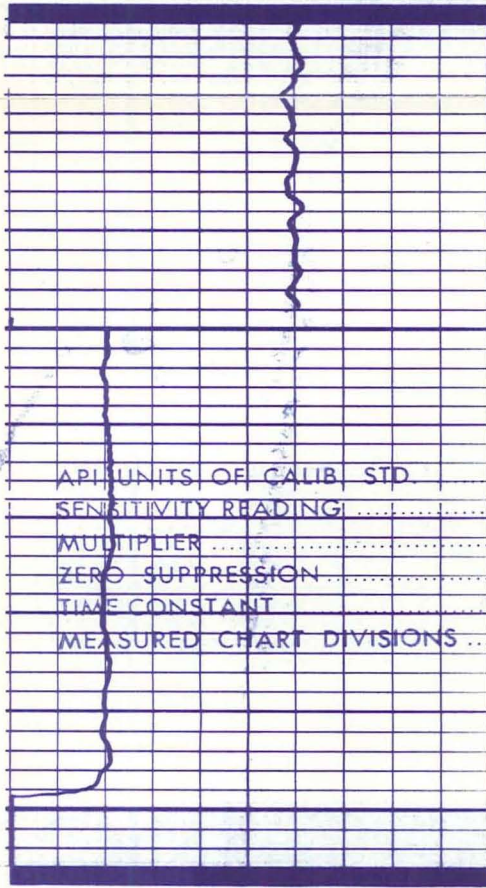

API UNITS OF CALIB STD 185
 SENSITIVITY READING 200
 MULTIPLIER X1
 ZERO SUPPRESSION 0
 TIME CONSTANT 2
 MEASURED CHART DIVISIONS 4

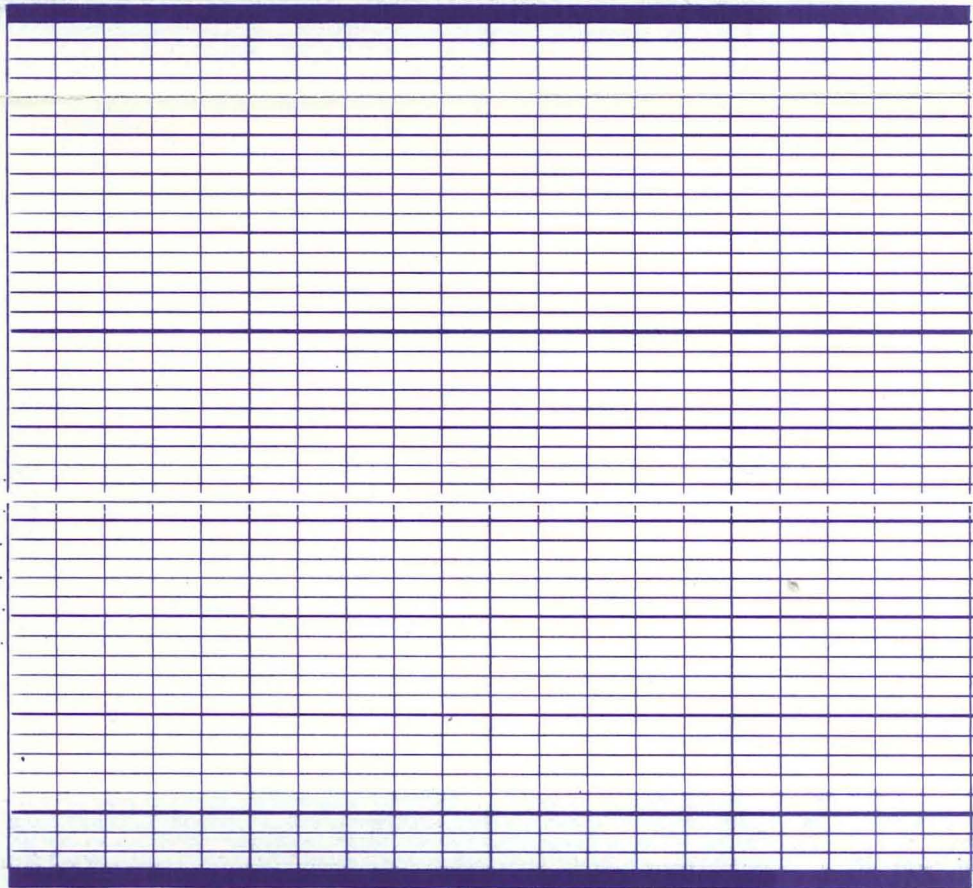

Division of Dresser Industries, Inc.

GL02593
 FILE_CAB_15_DRAWER_2

*Cross (cont)
 580'*