

# NEVADA BUREAU OF MINES AND GEOLOGY

---

*BULLETIN 97*

## **DISCOVERY AND GEOLOGY OF THE DESERT PEAK GEOTHERMAL FIELD: A CASE HISTORY**

**Walter R. Benoit, John E. Hiner, and Robert T. Forest**

A case history of the exploration, development (through 1980), and geology of the Desert Peak geothermal field. Contains sections on geochemistry, geophysics, and temperature-gradient drilling.



**UNIVERSITY OF NEVADA • RENO  
1982**

# UNIVERSITY OF NEVADA SYSTEM

## Board of Regents

Robert Cashell, *Chairman*

James L. Buchanan, II  
Frankie Sue del Papa  
Lilly Fong  
Dorothy Gallagher

Chris Karamanos  
John McBride  
John Tom Ross  
June Whitley

Robert M. Bersi, *Chancellor*

## UNIVERSITY OF NEVADA•RENO

Joseph N. Crowley, *President*

## MACKAY SCHOOL OF MINES

James Taranik, *Dean*

## NEVADA BUREAU OF MINES AND GEOLOGY

John Schilling, *Director/State Geologist*  
Keith G. Papke, *\*Assistant Director*

### INFORMATION SERVICES

Arlene Kramer, *Sales Clerk*  
Becky S. Weimer, *Geologic Information Specialist*  
\* Dennis R. Boulton, *student assistant*  
\* Mark P. Molinari, *student assistant*

### CLERICAL SERVICES

Helen Mossman, *Office Manager*  
Dorene E. Camp, *Secretary*  
\* Louise Gibbs, *Account Clerk*

### PUBLICATION SUPPORT

Susan L. Tingley, *Publication Manager/Cartographer*  
Bridgett Boulton, *Editor*  
Janet Amesbury, *Phototypesetter*  
Larry Jacox, *Graphic Artist*  
\* Mati A. Stephens, *Assistant Editor*

### TECHNICAL SUPPORT

John Foss, *Mineral Preparator/Shop Mechanic*  
Norm L. Stevens, *Geology/Geophysics Assistant*

### NEVADA MINING ANALYTICAL LABORATORY

*Chemist*  
Brenda Keller, *Assistant Chemist*  
*Chemical Assistant*

### BASIC GEOLOGY, GEOCHEMISTRY, & GEOPHYSICS

Harold F. Bonham, Jr., *Geologist*  
\* John W. Erwin, *Geophysicist*  
\* Liang-chi Hsu, *Geochemist*  
\* Trowbridge Grose, *Research Associate*

### MINERAL-RESOURCES GEOLOGY

Larry J. Garside, *Energy-Resources Geologist*  
Richard B. Jones, *Metal-Resources Geologist*  
Keith G. Papke, *Industrial-Minerals Geologist*  
Joseph V. Tingley, *Economic Geologist*  
\* Jack Quade, *Geologist\*\**  
\* Jo L. Bentz, *Junior Geologist \*\**  
Daphne D. LaPointe, *Junior Geologist \*\**  
\* Peggy L. Smith, *Junior Geologist \*\**  
\* Ahmed Mohsen, *student assistant \*\**  
Paul Martin, *student assistant \*\**

### ENGINEERING & URBAN GEOLOGY

John W. Bell, *Engineering Geologist*  
Gail C. Szecsody, *Earthquake-Hazards Geologist\*\**

### COOPERATIVE PROGRAMS

U.S. Geological Survey  
Geology, mineral, and water resources  
National Cartographic Information Center  
National Mapping Division  
Eugene S. Faust, *State Resident Cartographer \*\**  
U.S. Bureau of Mines  
Mineral statistics & activities  
Nevada Division of Mineral Resources, Department of  
Conservation and Natural Resources  
Oil & gas drilling samples, logs, and other data  
Mineral activity  
Nevada State Mine Inspector  
Mining activity  
New Mexico Bureau of Mines and Mineral Resources  
*Isochron/West—the Journal of Isotopic Geochronology*

\* part time  
\*\* non-state funded

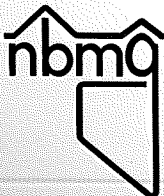

First edition, first printing, 1982: 1000 copies  
Edited by Bridgett Boulton  
Cartography by Larry Jacox  
Typeset in Compugraphic English Times at the  
Nevada Bureau of Mines and Geology  
Typesetting by Janet Amesbury  
Pasteup by Mati Stephens  
Printed by A. Carlisle & Company of Nevada

**C. W. BERGE**

**NEVADA BUREAU OF MINES AND GEOLOGY**

---

*BULLETIN 97*

**DISCOVERY AND GEOLOGY  
OF THE DESERT PEAK GEOTHERMAL  
FIELD: A CASE HISTORY**

**Walter R. Benoit, John E. Hiner, and Robert T. Forest**

A case history of the exploration, development (through 1980), and geology of the Desert Peak geothermal field. Contains sections on geochemistry, geophysics, and temperature-gradient drilling.



**UNIVERSITY OF NEVADA • RENO  
1982**

## CONTENTS

Introduction	3
Purpose and Scope	3
Location and Physical Features	3
History	4
Previous Work	6
Regional Geology	6
Geothermal Exploration Prior to 1973	7
Shallow Temperature-Gradient Holes	12
Roving Dipole Electrical Resistivity Survey	14
Desert Peak Well 29-1	15
Desert Peak Stratigraphic Tests One Through Five	20
Stratigraphic Test No. 1	21
Stratigraphic Test No. 2	21
Stratigraphic Test No. 3	23
Stratigraphic Test No. 4	24
Stratigraphic Test No. 5	24
Temperature Cross Section A-A'	25
Desert Peak Well B21-1	29
Desert Peak Well B21-2	29
Desert Peak Stratigraphic Tests Six Through Eight (and others)	34
Stratigraphic Test No. 6	34
Stratigraphic Test No. 7	34
Stratigraphic Test No. 8	34
Other Stratigraphic Tests	34
Magnetotelluric Survey	36
Desert Peak Well B23-1	39
Near-Surface Thermal Aquifers	44
Estimated Depth to 400°F and Producing Zones in the Reservoir	46
The Desert Peak Reservoir	48
Geochemistry	52
Data Quality and Sample Collection	54
Scale	56
Isotopes	57
Geology	57
Rock Units	59
Mesozoic	59
Tertiary Rhyolites	59
Chloropagus Formation	61
Desert Peak Formation	61
Truckee Formation	62
Younger Volcanic Rocks	62
Andesite Ash-Flow Tuffs	62
Desert Queen Intrusive	63
Quaternary Alluvium	63
Structure	63
Gravity	65
Geologic Structure and the Geothermal Reservoir	69
Conclusions	71
Appendix 1—Temperature-Gradient Drill Holes	72
References	80

See page 82 for list of plates.

## INTRODUCTION

### PURPOSE AND SCOPE

In November 1976 Phillips Petroleum Company culminated a three-year exploration effort by drilling a geothermal discovery well near Desert Peak, in northwestern Churchill County, Nevada. This discovery, the Desert Peak geothermal field, has since been proven by the drilling of two more deep test wells. As the geothermal field has a notable lack of surface thermal manifestations, the Desert Peak geothermal field is the first blind geothermal discovery in the Basin and Range physiographic province of the southwestern U.S.

The present status of the young geothermal industry is comparable to the early petroleum industry when oilmen drilled near oil seeps and other surface petroleum phenomena. As the areas around surface phenomena were drilled out or otherwise exhausted, the knowledge gained was used to step out into areas where there were no indications of petroleum. Continuation of such actions led to highly sophisticated petroleum exploration techniques seen today. Similarly, geothermal exploration in Nevada has evaluated and drilled areas with obvious power generation potential. In some instances, evaluation and drilling have occurred several times, and many of the hot springs areas that were tested are now exhausted. The geothermal industry must now follow the petroleum industry's example and enter areas of blind exploration; the knowledge gained must be used to develop a sound strategy for blind geothermal resource exploration. The future of geothermal energy and the geothermal industry in North America largely depends on the explorationist's ability to identify and develop viable new geothermal prospects.

Development of blind geothermal resource targets will require the application of every available exploration tool. Since the credibility of each tool is determined by its past successes or failures, it is imperative that past successes be as visible as possible. Realizing this, the Department of Energy has implemented several industry-coupled programs designed to acquire and make public information necessary for development of a sound exploration strategy. Geothermal exploration companies have responded favorably and have helped ensure moderate success for these programs.

In 1979 Phillips Petroleum Company drilled the most recent deep test well at Desert Peak in conjunction with the Department of Energy's reservoir assessment program. Data resulting from this cooperative effort were submitted to the Department of Energy and are now available to the public; however, very little information concerning the exploration, discovery, and early development of the Desert Peak geothermal field was available prior to this report.

The discovery of the Desert Peak geothermal field is evidence that blind geothermal resource exploration has begun—the second stage of geothermal exploration. As numerous exploration methods were employed, and as Desert Peak is a blind discovery, a discussion of the entire Desert Peak exploration strategy is necessary. By making such information available perhaps we can help the geothermal industry develop effective exploration strategies in the relatively untested Great Basin.

The best format for presentation of this information is a case history of the exploration, development, and geology of the Desert Peak geothermal field. We have attempted to present the procedures utilized at Desert Peak, in chronological order whenever possible. Interpretations and the relative importance of the various methods are stated throughout this publication. The evolution of Phillips' (and most other geothermal exploration companies) present exploration procedures in the Great Basin resulted largely from our efforts at Desert Peak.

The authors are grateful to Phillips Petroleum Company for permission to publish and assistance in preparing this report. Gratitude is also expressed to Thermal Power Company and Southland Royalty Company for permission to publish information from their stratigraphic tests in the Desert Peak area. Larry Gar-side reviewed the manuscript and was instrumental in assisting this project from conception to reality. Stuart Johnson, John Maas, and Frank Yeaman helpfully reviewed parts of the manuscript. Jake Rudisill provided information on the geothermal wells at Brady's Hot Springs. Dianne Feist spent innumerable hours typing and retyping the manuscript, and Stephanie Hughes and Trudi Peek did most of the original drafting.

### LOCATION AND PHYSICAL FEATURES

The Desert Peak geothermal field is located approximately 50 miles east-northeast of Reno, Nevada, in the northern portion of the Hot Springs Mountains of northwestern Churchill County, Nevada (figs. 1 and 2). The geothermal field is approximately centered in S22,T22N,R27E. Brady's Hot Springs, the site of the world's first large-scale geothermal food processing operation, is located adjacent to Interstate 80 about 4 miles northwest of the Desert Peak geothermal field.

The Hot Springs Mountains are accessible via Interstate 80 on the west and Nevada State Highway 95 on the east. Numerous unpaved roads and jeep trails provide excellent access in the northern portion of the Hot Springs Mountains. Most areas can be reached with a four-wheel-drive vehicle. However, large portions of the Hot Springs Mountains are mantled by windblown sand which effectively limits two-wheel-drive vehicles to existing roads.

The Hot Springs Mountains are a desolate range of hills with generally subdued topography. Elevations vary from 4000 feet in the surrounding playas to 5365 feet at the summit of Desert Peak. The climate in the region is arid, and precipitation is estimated at 4 to 6 inches per year. Most of the precipitation occurs as rain and snow in the winter months, although occasional summer thunderstorms furnish small amounts of rain. Summers are warm; the mean July daily maximum temperature is 92°F. Winters are mild, and the mean January daily minimum temperature is about 15°F. Afternoon temperatures in the winter are generally between 40 and 60°F. However, temperatures can be extreme and may vary between winter lows of -20°F and summer highs of 110°F (Houghton and others, 1975).

Vegetation is sparse but variable depending upon soil conditions, water availability and quality, and altitude. A Basin Sage community dominates the higher eleva-

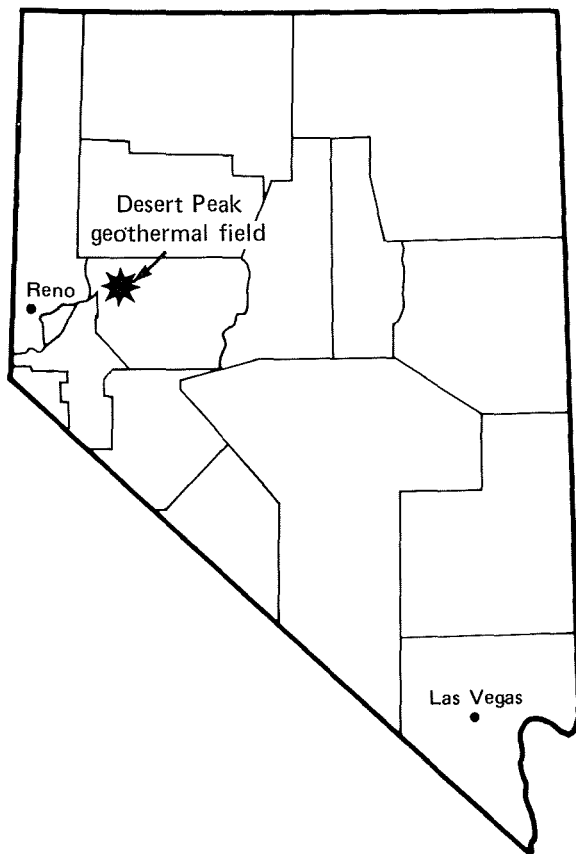

FIGURE 1. Location of Desert Peak geothermal field, Churchill County, Nevada.

tions, giving way to shadscale populations in the lower areas. Saltgrass and samphire characterize surface geothermal manifestations. A more complete inventory of species can be found in Axelrod (1956).

There are no springs within the Hot Springs Mountains, and waters occurring around the margins of the hills are moderately to highly saline. Consequently, the animal population is restricted to a small herd of wild burros as well as coyotes, rabbits, rodents, lizards, snakes, and a variety of birds.

Land use is currently limited to geothermal activities, a buried transcontinental telephone line, cattle grazing, and sporadic mineral prospecting. Recreational use of the Hot Springs Mountains is minimal.

## HISTORY

Due to the desolate nature of the Hot Springs Mountains, the history of the area has been dominated by a series of people passing through, or by people searching for and attempting to produce a wide variety of mineral resources. Although there is a lack of known archaeological sites and artifacts in the Hot Springs Mountains, Indians probably visited nearby Brady's Hot Springs regularly. Early explorers visited Brady's Hot Springs but rapidly moved on in search of more productive land.

The pioneers bypassed the Hot Springs Mountains by using the Carson River and Truckee River branches of the California Trail on the east and west, respectively. To pioneers on the Truckee River branch of the Califor-

nia Trail, Brady's Hot Springs, then known as Tenderfoot Station, were always a blessing and occasionally a curse. The springs were located near the middle of the dreaded Forty-Mile Desert and the water was potable when cooled. However, thirst-crazed oxen were commonly scalded when they rushed into the boiling water.

As early as 1849 prospectors, or more likely, immigrants travelling along the California Trail in search of water in the nearby hills discovered gold and silver mineralization at the site of the Desert Queen Mine (Vanderburg, 1940) at the northeastern margin of the Hot Springs Mountains. This would be the first lode mine worked in northern Nevada if it were discovered in 1849. In 1863 the first mill was built to recover gold and silver from the ores of the Desert Queen Mine. Over the years at least three mills were constructed, yet the total production probably has been less than \$50,000. The Desert Queen Mine and the nearby Fallon Eagle Mine were last worked in the 1930's and 1940's. There has been no recorded production since 1951 according to U.S. Bureau of Mines Minerals Yearbooks (Willden and Speed, 1974).

In 1869 the extensive salt deposits of Eagle Marsh (informal name), located about 7 miles southwest of Desert Peak, were discovered by B. F. Leete. Between 1870 and 1915 Eagle Marsh probably produced over 500,000 tons of salt, primarily for use in milling silver ores in Virginia City and Humboldt County. The salt was collected by desiccating brines in vats 50 feet wide and 100 feet long. The brine was initially supplied by springs on the east side of the marsh (Russell, 1885). Later, brine was pumped from a depth of about 20 feet (Willden and Speed, 1974). During good weather 1 acre of vats produced 10 tons of salt per day. Exceptionally pure salt was recovered at White Plains, located on the flats northeast of the Hot Springs Mountains, by the Desert Crystal Salt Co. between 1870 and 1912. Production amounted only to about 200 tons a year (Paheer, 1970).

Between 1869 and 1912 the Central Pacific Railroad had a station near Brady's Hot Springs known simply as the Hot Springs Station. During this time Brady's Hot Springs were referred to as Hot Springs or Boiling Springs. Russell (1885) visited the site and described the hot springs as follows: "At a number of orifices the waters of this spring issue in a state of active ebullition. When the openings become obstructed the steam escapes with a hissing and roaring sound." Russell also noted an earlier, unsuccessful attempt to recover boric acid from the thermal waters; Lincoln (1923) reported this attempt was made in 1871.

In contrast, Bishop (1970) noted that the hot springs were owned by a German company attempting to recover borax from a nearby mine. Bishop reports: "They were badly sold by sharpers who induced them to believe that borax in large quantities could be obtained here. . . . We believe some 60 boxes of the manufactured article was all that was ever turned out, and then the mine suddenly gave out, the production ceased, of course, and the company after an expenditure estimated at about a quarter million dollars, ceased operations, their property remaining idle."

Diatomite production from quarries along the northwest margin of the Hot Springs Mountains began prior

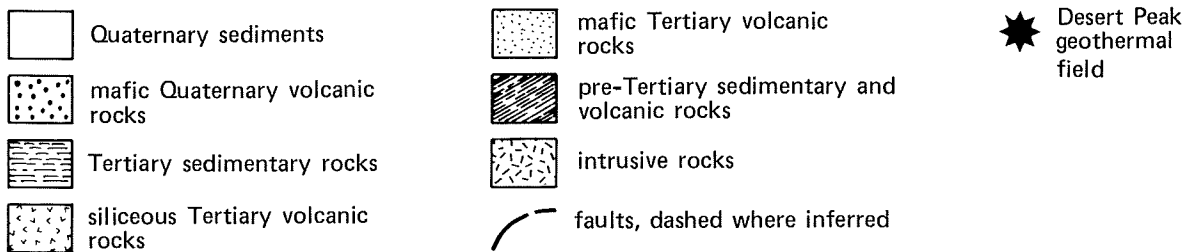
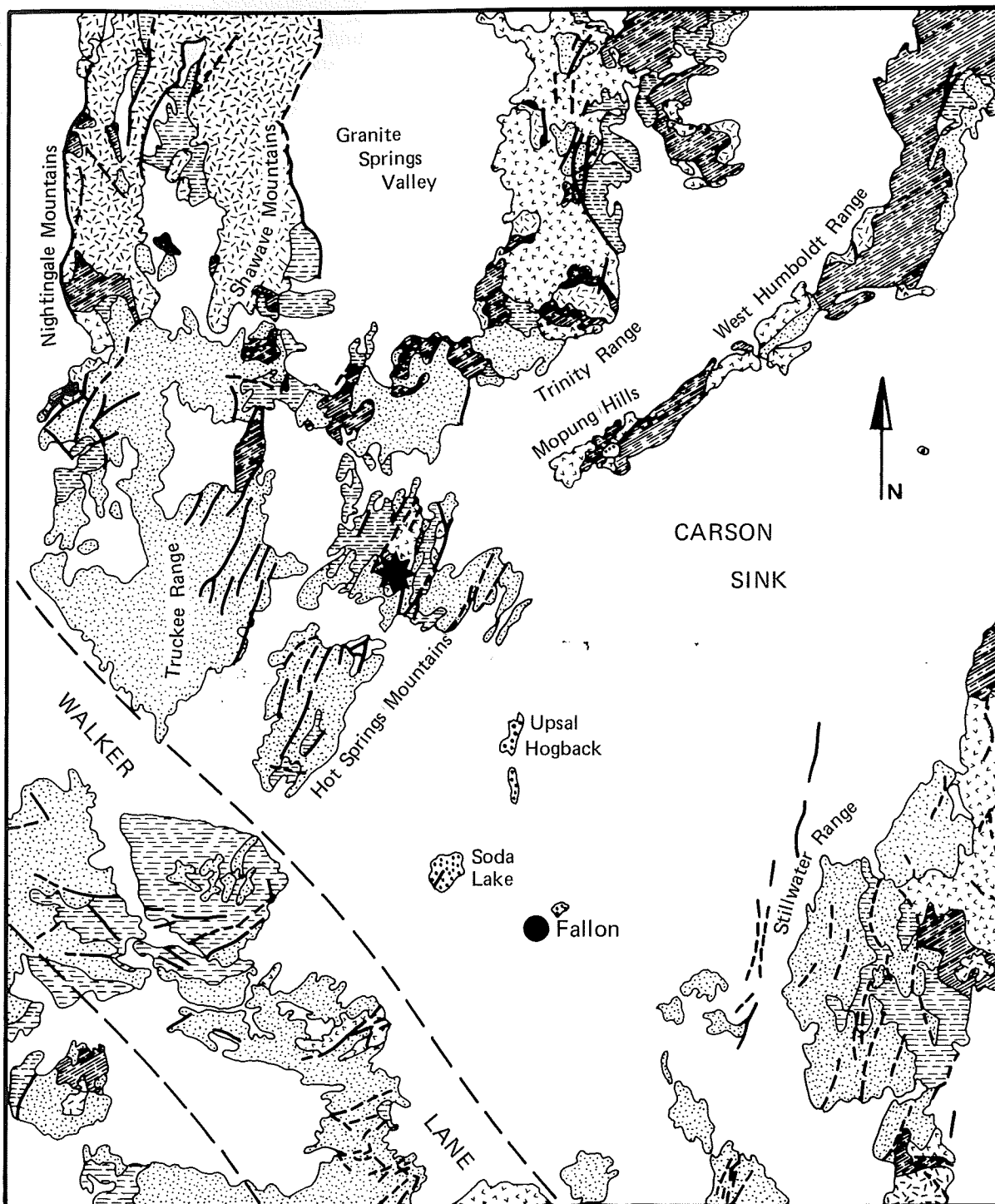

**FIGURE 2.** Simplified regional geology map of Desert Peak geothermal field, Churchill County, Nevada (from Stewart and Carlson, 1978).

to 1940 and has continued intermittently. In the vicinity of the Desert Peak geothermal field there are numerous bulldozer cuts in outcrops of diatomaceous material but there has been no production. Substantial quantities of high-quality diatomite are apparently still available in the Hot Springs Mountains.

Brady's Hot Springs was the site of a resort and spa for many years. In the 1930's it was known as Springer's Hot Springs (Vanderburg, 1940). Later the Brady family purchased the resort and the name Brady's Hot Springs has been used since the 1940's. Prior to 1959 the resort consisted of a spa, campground, bar, restaurant, gas station, and cabins. When the springs dried up, apparently due to geothermal drilling in 1959, the spa lost its hot water supply and closed. The resort was abandoned a few years later when the interstate freeway was completed, and shortly thereafter the buildings were burned. All that remains is the swimming pool. The area remained vacant until 1978 when Geothermal Food Processors, Inc. began operating the world's first geothermal food processing plant, using one of the existing geothermal wells to provide hot water as a source of process heat and wash water.

## PREVIOUS WORK

The earliest published geological information on the Hot Springs Mountains is the report on the geology of the Fortieth Parallel (King, 1878). Russell (1885) briefly described the area in his famous monograph on Lake Lahontan. Vanderburg (1940) compiled information on the mining districts of Churchill County and gave a brief description of activities in the Desert district, which lies in the northeastern portion of the Hot Springs Mountains. Axelrod (1956) mapped a small portion of the Hot Springs Mountains in detail while studying the fossil flora of the area. His work represents the most detailed compilation of stratigraphy and structure to date. Geologists of the Southern Pacific Land Company conducted reconnaissance field mapping and mineral occurrence inventories in the 1950's and early 1960's (unpub. reports of Southern Pacific Company). Harrill (1970) conducted a water resources appraisal of Granite Springs Valley and surrounding areas, which includes a part of the Hot Springs Mountains. Willden and Speed (1974) mapped in the Hot Springs Mountains as part of a comprehensive study of the geology and mineral deposits of Churchill County.

Previously published and unpublished papers in the area have concentrated on the geology and geothermal developments at Brady's Hot Springs. Oesterling and Anciale (1962) described the detailed geology and first geothermal developments at Brady's Hot Springs; Middleton (1962) conducted flow tests on some of the Brady's geothermal wells, and Garside (1974) published data on the Brady's geothermal wells. Olmsted and others (1975) conducted a hydrogeologic appraisal of the Brady's Hot Springs system. Rudisill (1978) and Rudisill and Dykstra (1978) have performed injection tests and reservoir analyses of the Brady's geothermal reservoir in conjunction with development of the Geothermal Food Processors, Inc. food dehydration plant. Brogan and Birkhahn (1980) have studied a part of Brady's Fault in detail. Garside and Schilling (1979)

also have published limited geological information on both the Brady's and Desert Peak areas. Limited amounts of data and discussion of the Desert Peak geothermal field have been previously published by Benoit (1978a, 1978b). The geology of the northern part of the Hot Springs Mountains has recently been mapped in detail by Hiner (1979) and the entire Hot Springs Mountains have been mapped on a reconnaissance basis by Voegtly (1981).

## REGIONAL GEOLOGY

The Hot Springs Mountains lie in west-central Nevada near a transitional zone between the Basin and Range physiographic province and the Sierra Nevada province (Bonham, 1969). They also form part of the northwestern boundary of the large Carson Sink depression (fig. 2).

Information concerning pre-Mesozoic stratigraphy and structure west of the Carson Sink is meager. Available evidence from adjacent regions to the north and east suggests that west-central Nevada was the site for deposition of eugeosynclinal rock types throughout most of the Paleozoic Era (Silberling and Roberts, 1962; Bonham, 1969). The late Paleozoic Antler and Sonoma Orogenies disrupted and telescoped the eugeosynclinal facies rocks eastward (Roberts and others, 1958), almost certainly affecting the Hot Springs Mountains region. Unfortunately, documentation of these effects is lacking, largely because the evidence has been covered or obliterated by post-Paleozoic rocks.

Rocks exposed in the Hot Springs Mountains region range from Triassic(?) to Holocene (fig. 2). The pre-Tertiary rocks comprise metamorphosed sedimentary and volcanic rocks thought to be Triassic and Jurassic which have been intruded by mafic and siliceous plutons. These rocks are extensively exposed east of the Carson Sink, as well as in the West Humboldt Range and in the Trinity Mountains (fig. 2). In general, well stratified Mesozoic rocks are prevalent east of the Carson Sink, whereas relatively nondescript metasedimentary, metavolcanic, and granitic intrusive rocks predominate to the west of the Carson Sink. West of the Carson Sink, age and stratigraphic relationships of the Mesozoic rocks are not clear (Bonham, 1969; Johnson, 1977; Willden and Speed, 1974) due to a lack of readily identifiable marker beds, discontinuous outcrops, and disruption by granitic intrusives. A large gabbroic intrusive, associated differentiates, and comagmatic extrusive units are exposed in ranges bordering the Carson Sink (Willden and Speed, 1974; Speed, 1976).

Early Mesozoic structure in the region is not well known. Structural complexities and their continuity are difficult to ascertain owing to regional metamorphism and the homogeneity of the pre-intrusive Mesozoic section.

Middle Jurassic folding and faulting is widespread in west-central Nevada. In places folds have been refolded, implying at least two phases of diastrophism. Near the Hot Springs Mountains refolding occurs in the Trinity Range (Willden and Speed, 1974).

In Middle Jurassic time, intrusion of a large lopolithic gabbro complex resulted in folding and thrust faulting. The lopolith intruded a small tectonic basin partially ex-



posed at present in the Clan Alpine Mountains, the Stillwater Range, the West Humboldt Range, and the Mopung Hills (Speed, 1976). The depositional and structural history of the lopolith is complex. Rocks of the lopolith include intrusives ranging from gabbro to diorite in composition as well as comagmatic extrusive units of basalt. The gabbro complex intruded a syn-tectonic suite of Middle Jurassic carbonates and arenites which collected in a small depositional basin (Speed and Jones, 1969) and is floored by pelitic sediments of the Auld Lang Syne Group. Two major thrust fault zones are associated with the lopolith. The presence of several other thrusts in the West Humboldt Range (Speed, 1976) may be indicative of a pervasive imbricate thrust structure along the western margin of the lopolith.

The pre-Tertiary rocks were regionally metamorphosed to greenschist facies prior to the Cretaceous intrusion of granitic plutons (Bonham, 1969). Locally intense contact metamorphism, fracturing, and faulting of country rock resulted from the granitic invasion.

Cenozoic geology in west-central Nevada reflects a period of intense volcanism complicated by pervasive basin-and-range faulting. Tertiary rocks are primarily volcanic and consist of complexly interfingered sequences of flows, tuffs, and shallow intrusive rocks. Fluvial and lacustrine intercalations occur sporadically and locally are differentiated to formation rank. Alluvial and lacustrine sediments dominate the Quaternary Period. Cenozoic rocks are separated from the pre-Tertiary section by an unconformity of regional extent (Albers, 1964). Cenozoic deformation consists of high-angle normal faulting and tilting of basin-and-range blocks. Folding is locally pervasive (Roberts and others, 1967).

Oligocene(?) volcanics ranging from basalt to rhyolite in composition commonly overlie pre-Tertiary rocks in northern Washoe and southeastern Pershing Counties (Bonham, 1969; Johnson, 1977). Elsewhere in the region, Miocene silicic volcanics form the base of the Tertiary section (Willden and Speed, 1974). Deposition of Miocene units was accompanied or shortly followed by block faulting which generated enclosed basins of varying sizes and longevity. These basins may have appeared as no more than short-lived undulations on the surface of the volcanic field (Axelrod, 1956). Lacustrine sedimentation in these basins accompanied continued extrusion of intermediate and mafic volcanic rocks in late Miocene and Pliocene time. The sedimentary units are generally thin, discontinuous, highly variable laterally, and they amount to only minor additions to the volcanic pile. A few basins, however, were sufficiently large and long lived for acceptance of large amounts of sediment and volcanic rocks, giving rise to such predominantly sedimentary formations as the Esmeralda, Humboldt, and Truckee (Axelrod, 1956). Source areas for the voluminous volcanic flows and ash-flow tuffs have been recognized in the form of collapsed calderas. Caldera depressions have been recognized in Churchill County (Riehle and others, 1972) and in the southern Tobin and Trinity Ranges in Pershing County (Burke and McKee, 1973; Willden and Speed, 1974). Other calderas undoubtedly occur in the region.

The Basin and Range physiographic province is largely the result of deformation which began in early

Miocene time (Zoback and Thompson, 1978). Widespread and pervasive high-angle faulting raised and often tilted large blocks of the earth's crust, creating the well known horst-and-graben structure of present-day Nevada. Major faults in the region trend north to northeast, bound the ranges on one or both sides, and commonly fragment the interiors of the ranges.

The origin of the basin-and-range structure has intrigued many geologists, and many years of detailed local and regional studies have produced two principal theories. One theory states that observed tensional features are directly related to deep-seated extension of the lithosphere (Proffett, 1977). The second theory interprets basin-and-range extension as an adjustment to regional horizontal shear (Bonham, 1969). Horizontal shear forces marginal to and within the Basin and Range physiographic province are expressed as northwest-trending topographic and structural lineations (Sales, 1966). One such structural element, the Walker Lane (Locke and others, 1940), occurs about 6 miles southwest of the Hot Springs Mountains (fig. 2). Originally defined as a topographic lineament (Billingsley and Locke, 1939), aeromagnetic and gravity data indicate that the Walker Lane is a major, deep-seated crustal disruption of the characteristic basin-and-range pattern in western Nevada (Trexler and others, 1978).

Local crustal shortening, expressed by folds in the Tertiary rocks, occurs in many places in west-central Nevada (Axelrod, 1956; Willden and Speed, 1974). Fold wavelengths vary from a few feet to thousands of feet. Fold axes are generally subhorizontal and limbs may dip as much as 70° but more commonly range from 10° to 40°. Large folds trend north or northeasterly. Smaller folds often trend and plunge southeast. The folds are near and subparallel to the northeast-trending basin-and-range faults and may have originated through local compressive stresses caused by faulting.

Quaternary alluvial and lacustrine deposits cover more than half the region. Isolated pediment gravels veneer many low-lying areas. Quaternary volcanics consist of basalt and basalt tuff and are exposed in the Carson Sink at Upsal Hogback and Rattlesnake Hill (Morrison, 1964). Pleistocene Lake Lahontan sediments underlie the Carson Sink and are approximately coeval with the basalts there (Willden and Speed, 1974). Lake Lahontan deposits are also found in most of the other valleys in the region. Finally, unconsolidated alluvium and local sheet and dune sands deposited by wind and water now largely obscure older rocks at lower elevations and occasionally at higher elevations within the region.

## GEOTHERMAL EXPLORATION PRIOR TO 1973

Prior to 1959 Brady's Hot Springs provided such an obvious display of thermal energy that it was correctly regarded as an excellent target for exploration. No springs are present in the area today, but an early description of the hot springs in 1863 (Yager, 1971) leaves no doubt that they were impressive. He writes: "One of them I consider a great curiosity. It could be heard over

one hundred yards. It boiled up through the crevices of the rocks in a perfect foam, throwing part of the water four feet high and spattering it for several feet around. A column of steam rises from it equal to that from the escape pipe of a steamboat. There are quite a number of others close by of various sizes and depths. One surrounded by large rock, about thirty feet long, twelve feet wide and six feet deep, [and] very clear; it looked more like a [reservoir] of hot water than a spring. Most of the springs are very hot, though they vary in temperature [and] a little sulphurous. One of them was cool but brackish. . . . There must be as many as thirty or forty hot springs at this point." A report in the Sacramento Daily Union (1864) suggests that geysers were present at Brady's Hot Springs: "I was assured by persons living near that only a few weeks since a large body of hot water was forced up to a [height] of twenty feet."

In 1959 Oesterling and Anctil (1962) reported that "the only thermal activity at the surface was a 180°F hot springs pool, two 204°F fumaroles located immediately north of the hot springs and one fumarole a short distance south of the springs." Apparently many of the springs mentioned by Yager (1971) had sealed themselves shut. Russell (1885) also noted that "the deposits from the waters closed previous channels of discharge."

All the thermal features at Brady's Hot Springs are located along Brady's Fault. This fault is visible over a distance of 6 miles and appears to be a westward-dipping normal fault. Infrared imagery clearly reveals the thermally active portion of this fault. The stratigraphic displacement on the fault is believed to be about 500 feet (Hiner, 1979), but where observed, the fault scarp is generally less than 6 feet high.

In addition to the hot springs and fumaroles there are several other indications that Brady's Hot Springs is a potentially economic geothermal prospect. Abundant opaline sinter is found for a distance of about 2.3 miles along the trace of Brady's Fault, suggesting that this length is thermally active (Oesterling and Anctil, 1962). A small amount of cinnabar and native sulfur is associated with the hot springs (Bailey and Phoenix, 1944). There is also an abundance of intensely hydrothermally altered alluvial material associated with the fault; this material is altered to heavily iron-stained, soft kaolinite. The silica, sodium-potassium, and sodium-potassium-calcium geothermometers suggest the subsurface temperature is near 400°F. However, chemical geothermometers, taken for granted now, had not been developed in 1959 when the first geothermal wells were drilled. Simply stated, the impressive surficial features of the hot springs and fumaroles initially prompted geothermal exploration at Brady's Hot Springs.

The first mention of wells drilled in the Brady's area comes from Bishop (1970): "Great efforts have been made here to sink artesian wells in order to obtain fresh water for the use [on] the road. First a depth of 800 feet was reached, then 1000 feet, and lastly 1300 feet, but all without success. In some portions of work very rapid progress would be made—95 feet having been made in one day—then some hard, flinty rock would be struck,

and progress of less than one foot per day would be the result. The project had to be abandoned at last." This well was apparently drilled near the Hot Springs Station to avoid the mineralized thermal water. In October 1959 Magma Power Company began drilling the first geothermal exploration well in the area, Brady no. 1 (table 1). This well is located near the thermal springs (fig. 3) and was drilled to a depth of 690 feet with a cable tool rig. It was deepened to 1800 feet by Earth Energy, Inc. with a rotary rig in 1965. This well is located in the footwall block about 100 feet east of the west-dipping Brady's Fault; consequently, it did not intersect the fault and was not a producer. A temperature profile of this well is shown on figure 4. Whether or not this is an equilibrium profile is not known. (The term equilibrium profile as used in this report means a temperature profile free of temperature disturbances caused by the drilling process. Other discrepancies in the equilibrium temperature profiles should be long term and caused by geologic processes.)

A second well, Brady no. 2, was drilled immediately after the first well. Brady no. 2 is either 241 or 340 feet deep (Middleton, 1962; Garside, 1974), has a bottom-hole temperature of 330°F (Oesterling and Anctil, 1962), and may have crossed Brady's Fault at a depth of 152 feet. Production data for this well are shown on table 1. Oesterling and Anctil (1962) reported "that after the no. 2 steam well blew in, steam vents gradually worked open to the north and the original hot springs pool was desiccated. Some mud pots located 200 feet N23°E of the no. 3 well were born with explosive force. Numerous areas of hot, moist ground developed, most with some steam escaping from cracks. The zone of thermal activity is 200–300 feet wide. On the east side of the highway the creosote is boiling out of the base of a telephone pole. . . . There were some 105 of these surface phenomena as of May 24, 1960, most of which were induced as a result of the tapping of a main steam-filled fissure [Brady Thermal Fault] by Magma no. 2 and no. 3 steam wells. . . . By mid-1961, all but a half dozen or so of these phenomena were dormant."

In mid-June 1979 this reactivation of surficial thermal features occurred again when Brady no. 5 blew out. Personnel from the Geothermal Food Processors plant were attempting to test Brady no. 5 as a possible back-up well for the plant when water and steam began flowing out around the casing at the surface. This water eroded the material from around the casing to depths of 6 to 10 feet, removing the lateral support for the casing. The old, corroded casing then broke and the wellhead toppled over. Within a few days the ground along Brady's Fault began to steam and hot springs, fumaroles, and mud pots appeared. These intriguing thermal features are shown on figure 5.

Brady no. 3 was drilled in early 1960 and was also a producer. Oesterling and Anctil (1962) believe this well intersected fractures in the hanging wall and not the main Brady's Fault. In late 1961 and early 1962 two successful wells, Brady no. 4 and no. 5, and two unsuccessful wells, Brady no. 6 and no. 7, were drilled by Magma Power Company. Brady no. 5 was deepened to 1800 feet in 1965 by Earth Energy, Inc. Figure 6 depicts three of the successful wells flowing.

TABLE 1. Data on Brady's geothermal wells.\*

Name/Designation on fig. 3	Date	Depth	Maximum temperature	Wellhead pressure (psig)	Flow rate (lbs per hour)			Remarks
					Water	Steam	Total	
Brady no. 1/ B-1	1959	1758 ft	355°F at 500 ft	0	---	---	---	Drilled to 690 ft in 1959 by Magma Power Co. with a cable tool rig. Deepened with a rotary rig in 1965 by Earth Energy Inc. Drilled in footwall. Temperature profile on fig. 4.
Brady no. 2/ B-2	1959 or 1960	241 ft or 341 ft	330°F	14.5	271,000	13,870	284,870	Drilled in hanging wall with cable tool rig by Magma Power Co.
Brady no. 3/ B-3	1960	512 ft or 610 ft	314°F at 240 ft 340°F(?)	9.5	156,500	12,400	168,900	Drilled in hanging wall with cable tool rig by Magma Power Co. Most fractures above 450 feet.
Brady no. 4/ B-4	1961	723 ft	340°F(?)	11.0	262,000	19,600	281,600	Drilled in hanging wall with cable tool rig by Magma Power Co. Began producing from a depth of 60 ft.
Brady no. 5/ B-5	1961 or 1962	1800 ft	320°F at 320 ft 340°F(?)	18.0	630,000 759,000 631,400	25,450 46,200 30,800	655,450 805,200 662,200	Drilled to 593 ft in hanging wall with cable tool rig by Magma Power Co. Deepened to 1800 ft by Earth Energy in 1965. Flow tested in 1962 and 1969.
Brady no. 6/ B-6	1961 or	770 ft	325°F 280°F flowing	0 30 (flowing)	---	---	---	Drilled in footwall with cable tool rig by Magma Power Co.
Brady no. 7/ B-7	1962	250 ft	220°F	0	---	---	---	Tools lost in hole and abandoned. Maximum depth ~300 ft.
Brady no. 8/ B-8	1975	3469 ft	340°F 270°F (while pumping)	0 30 (pumping)	---	---	336,000 (while pumping)	Well provides fluid for food dehydration plant.
Brady no. 9/ B-9	---	---	---	---	---	---	---	No information available.
Brady Earth Energy no. 1/ EE-1	1964	5062 ft	414°F	0	---	---	Unknown	Drilled by Earth Energy Inc. Temperature profile on fig. 4.
SP Brady no. 1/ SP Brady-1	1974	7275 ft	371°F	0	---	---	48,000 (while pumping)	Produced small quantities of fluid from 2000 ft. Temperature profile on fig. 4.
SP Brady no. 2/ SP Brady-2	1975	4446 ft	280°F or 300°F	---	---	---	120,000	Well reportedly geysers while flowing.
Injection well no. 1/IW-1	---	---	---	---	---	---	---	No information available.
Injection well no. 2/IW-2	---	---	---	---	---	---	---	No information available.

\*Data from Oesterling and Anctil (1962), Middleton (1962), Hansen (1969), Garside (1974), U.S. Geological Survey (1977), Rudisill (1978).

During 1964-65 Earth Energy Inc. drilled R. Brady EE no. 1 to a depth of 5062 feet. This well has a bottom-hole temperature of 414°F (fig. 4) but is not a producer, and it is not known if this is an equilibrium profile. This is the hottest well in the Brady's area, and an injection test has been performed on this well (Rudisill and Dykstra, 1978).

In 1975 Brady no. 8 was drilled to a depth of 3469 feet, and it supplies geothermal fluids to Geothermal Food Processors' food dehydration plant. A limited production test has been performed on Brady no. 8 in

conjunction with the food dehydration plant (Rudisill, 1978). Three other shallow wells have been drilled by Magma Power Company. These are Brady no. 9 and two shallow injection wells. There is no information available concerning these wells.

All of these wells are located along a narrow zone 1500 feet in length (fig. 3). Only two wells have been drilled outside this zone. The first, SP Brady no. 1, was drilled in 1974 to a depth of 7275 feet. This well had a low flow rate and a bottom-hole temperature of 371° (fig. 4). The second well, SP Brady no. 2, was drilled in

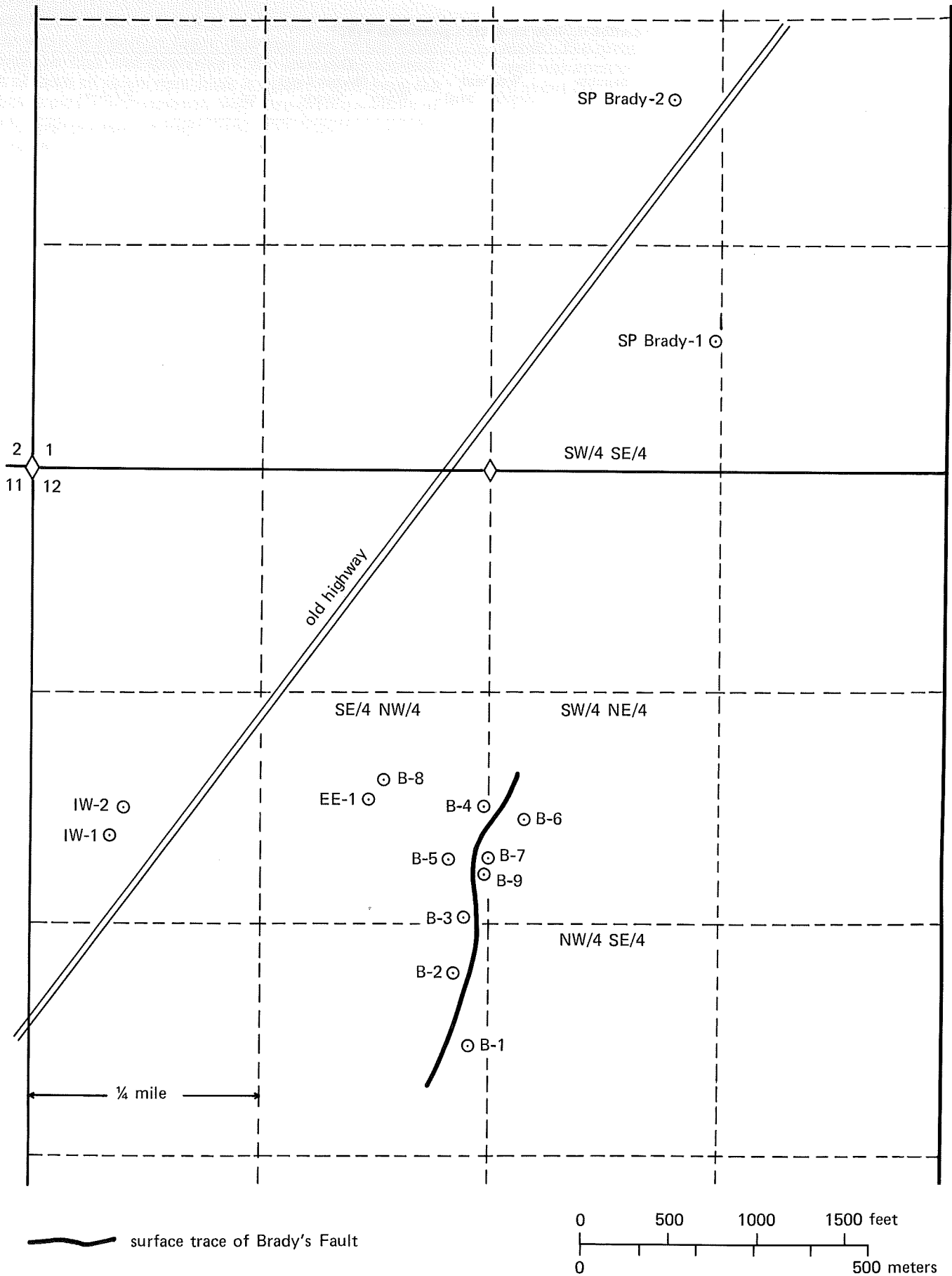

FIGURE 3. Drill hole location map at Brady's Hot Springs, S1,12,T22N,R26E (see table 1 for well descriptions).

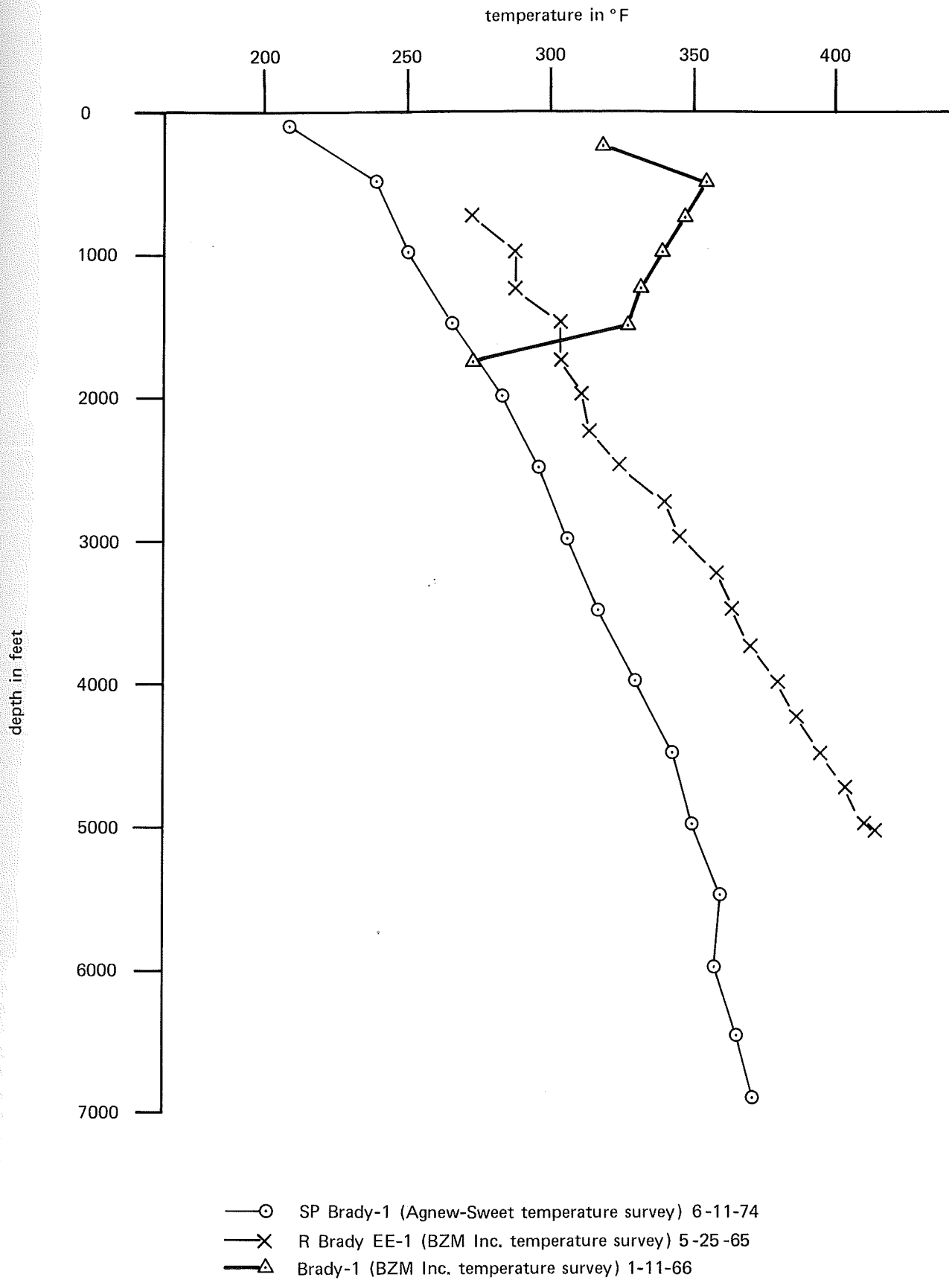
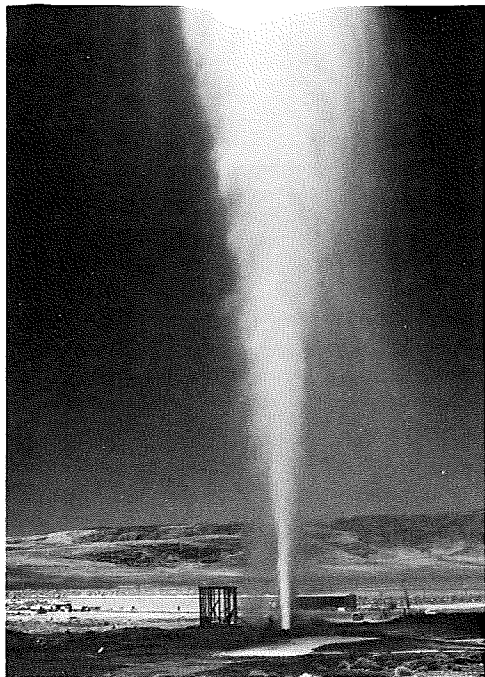

FIGURE 4. Temperature profiles for Brady's geothermal wells.



**FIGURE 5.** Active thermal features along Brady's Fault after Brady no. 5 blew out in June 1979.



1975 to a depth of 4446 feet. It has a maximum temperature near 300°F and reportedly produces 120,000 lbs per hour of fluid.

In 1971 the U. S. Geological Survey (Godwin and others, 1971) designated 19,020 acres in the vicinity of Brady's Hot Springs as a Known Geothermal Resource Area, indicating that the USGS considered Federal lands in the area promising enough to warrant expenditures of money for geothermal exploration and (or) development.

Prior to 1973 all geothermal exploration work had been done in the immediate vicinity of the thermal features along Brady's Fault. No geothermal exploration work had been conducted in surrounding areas because no one suspected the presence of another geothermal reservoir in the area. The Desert Peak geothermal field has no active surficial thermal features and only subtle nonthermal indications of its presence.

There are no hot springs, fumaroles, or mud pots associated with the Desert Peak field. A minor mercury occurrence was reported about ½ mile east of Brady's Hot Springs (Bailey and Phoenix, 1944). A few small patches of hydrothermal alteration and small, widely scattered calcareous and siliceous mounds may imply the presence of a geothermal reservoir nearby, but these features are common in western Nevada and in the majority of cases do not appear to be related to viable geothermal reservoirs.

### **SHALLOW TEMPERATURE-GRADIENT HOLES**

After a seven-year hiatus, geothermal exploration in the Brady's area resumed in 1973. The U. S. Geological Survey and the U. S. Bureau of Reclamation drilled 21

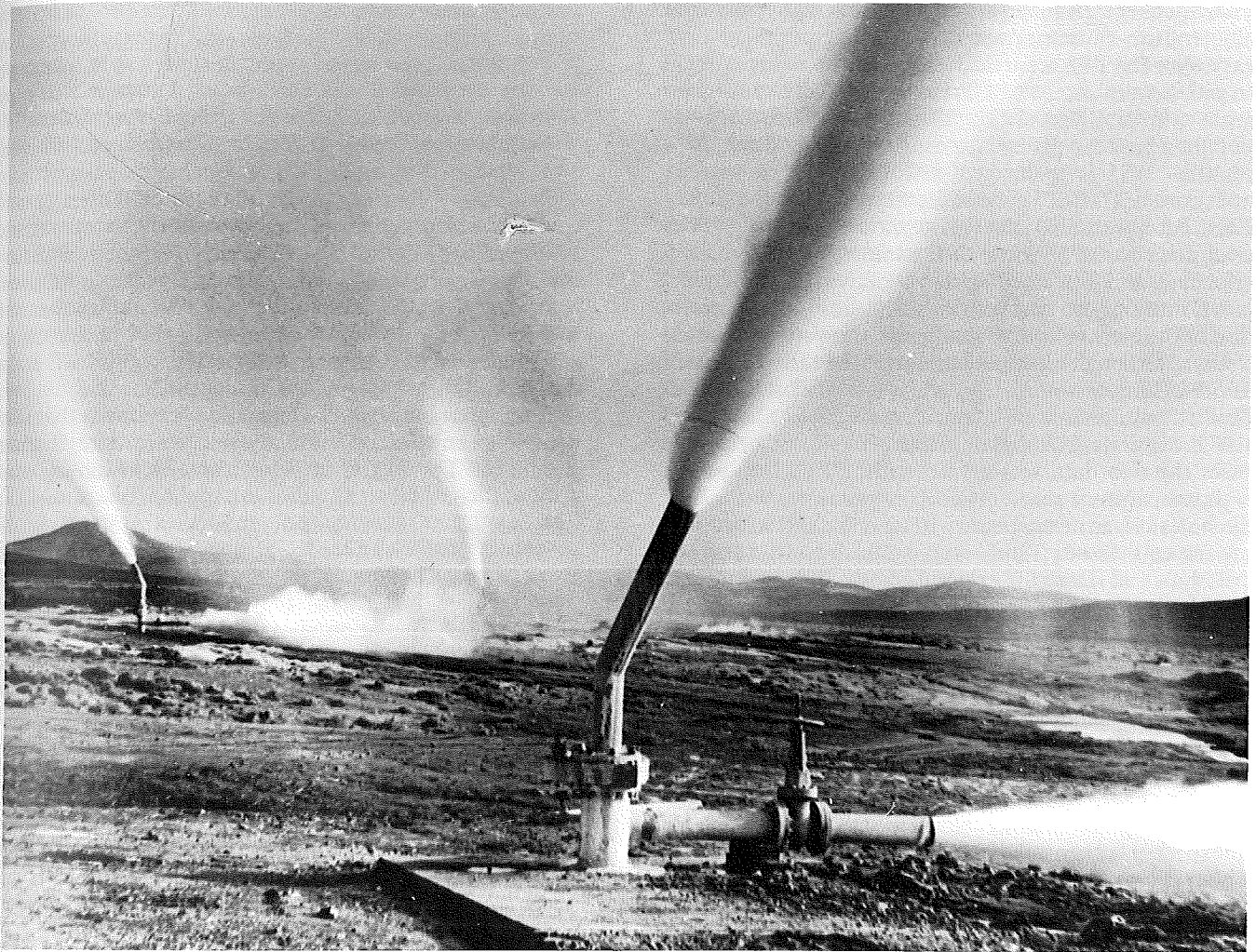

FIGURE 6. Three of Brady's geothermal wells flowing (photo from Garside, 1974).

shallow test holes to determine shallow subsurface temperatures and temperature gradients and to evaluate the movement of ground water (Olmsted and others, 1975). Most of these drill holes (hereafter referred to as holes) are located within 1 mile of Brady's Fault; those located more than 1 mile from Brady's Fault are located west of the fault. Union Oil Company also showed an interest in the area and drilled some shallow temperature-gradient holes.

In July 1973 Phillips Petroleum Company began a shallow temperature-gradient hole drilling program in the Brady's Hot Springs region. The Brady's area was chosen primarily because it had the highest measured temperature in Nevada at the time (414°F). A secondary factor was the presence of Southern Pacific Land Company land in the area; prior to beginning this exploration Phillips obtained the exclusive right to evaluate the geothermal potential and obtain geothermal leases on Southern Pacific lands in Nevada. The Southern Pacific Land Company owns most of the odd-numbered sections in the area.

Shallow temperature-gradient drilling was the first exploration tool used by Phillips in the area. Since the ultimate target in geothermal exploration is an economic and viable reservoir of heat, temperature gra-

dients were used, as they provide the most definitive information of all the geophysical exploration tools. The purpose of the shallow temperature-gradient program was to search for near-surface thermal evidence which might indicate a geothermal reservoir larger than that already discovered along Brady's Fault. It was fairly obvious that the small reservoir along Brady's Fault would not support a commercial power plant, yet the surrounding area had not been explored.

The shallow temperature-gradient holes were drilled with a small truck-mounted rotary rig using a 4 5/8-inch bit. Mud was the circulating fluid used to drill all the holes. The temperature-gradient holes were completed by running pipe in the hole with a cap on the bottom. The pipe was filled with water, a cement plug was set in the top of the annulus, and the hole was allowed to equilibrate for at least four days before temperature surveys were run. The temperatures were measured inside the pipe. Initially 3/4-inch galvanized pipe was used and later 1-inch schedule-40 PVC pipe became more convenient when subsurface temperatures were not extremely high.

Prior to 1976 the temperature equipment consisted of a digital multimeter and homemade thermistor probes which were calibrated with high-quality thermometers

immersed in liquid silicone. Although absolute temperature values obtained with this equipment may vary by a few degrees, relative temperatures are reliable to within a few tenths of 1°F. Over the course of the program several different thermistors were used. Correlation data between probes were not obtained. Holes drilled after 1975 were probed with digital thermometers and probes (DT-101) manufactured by Enviro Labs. This equipment is clearly superior to the probes used prior to 1976. Some of the initial holes have been relocated and reprobbed with the Enviro Labs equipment, and the two surveys generally show good correlation. The temperature gradients showed very little change, although absolute temperatures varied as much as 5°F. Comparison of temperature data obtained with Phillips' equipment and data from Olmsted and others (1975) suggests Phillips' data are reliable. In nearly all cases the two data sets agreed within 2°F. Due to the high temperature gradients and temperatures in most of the holes it was not necessary to have highly accurate or precise equipment. Temperature data from the shallow drill holes at Desert Peak are shown in appendix 1, and the locations of the holes are shown on plate 1.

The temperature-gradient holes were initially located at least 1 mile from Brady's thermal area and were spaced from 2 to 3 miles apart. The first seven holes were drilled near Brady's Hot Springs and produced only slightly anomalous temperature gradients, indicating that the thermal anomaly was confined to a part of Brady's Fault (pl. 1). Hole no. 8 had the first significantly anomalous temperature gradient in an unexpected location. Holes 11, 12, and 13 confirmed the discovery of a new, large, shallow thermal anomaly.

After hole no. 12 was drilled, the holes were limited to 300 feet or the depth reached in two days of drilling. There were three reasons for this decision. First, the holes usually did not show significant changes in the temperature gradient between depths of 300 and 500 feet. Second, the thermal anomaly appeared to be so intense that it could be easily defined with 300-foot-deep holes. Third, drilling costs were significantly reduced by limiting the holes to 300 feet.

Eventually a total of 53 shallow temperature-gradient holes were drilled to delineate the Desert Peak thermal anomaly (pl. 1). These holes show that an area of about 75 square miles has temperature gradients in excess of 6°F/100 feet. The thermal anomaly is also intense. Temperature gradients in the southwestern part generally exceed 20°F/100 feet, with a maximum of 64°F/100 feet measured in hole no. 37. Hole no. 37 also has the highest measured shallow-hole temperature in the area—a spectacular 291°F at a depth of 295 feet. The size and intensity of the Desert Peak thermal anomaly make it one of the most impressive thermal anomalies known in North America.

The preparation of a temperature-gradient map over a complicated hydrothermal system such as Desert Peak requires arbitrary decisions concerning treatment of nonlinear temperature profiles. For instance, if a temperature profile consists of more than one linear segment, then the deepest linear segment was used to construct plate 1. In holes 1, 11, 22, 44, and 52, high-temperature gradients near the surface became negligi-

ble or even negative at depth. In these few cases the temperature gradients are shown as either isothermal or as a temperature reversal on plate 1. However, the contouring on plate 1 was constructed to show the high temperature gradients near the top of these holes. No data shallower than 100 feet or deeper than 500 feet were used to construct plate 1.

Isothermal maps at depths of 100 and 300 feet (pls. 2 and 3) were prepared to accompany the temperature-gradient map. Both isothermal maps reveal temperature anomalies very similar to the temperature-gradient anomaly. The 100-foot isothermal map shows that the Desert Peak thermal anomaly would have been discovered if the shallow temperature-gradient holes had been limited to 100 feet in depth.

The later stages of exploration revealed that the Desert Peak thermal anomaly is a composite thermal anomaly. There are at least three known separate overlapping shallow thermal anomalies (pls. 2 and 3). The largest of the thermal anomalies appears to be centered in S29,T22N,R27E and is the main Desert Peak thermal anomaly. The second largest thermal anomaly is found in the northwestern part of T22N,R28E. This anomaly may be related to the main Desert Peak thermal anomaly. The most intense thermal anomaly surrounds Brady's Hot Springs. Another thermal anomaly is found in S25,T22N,R26E. This anomaly is small and appears to be on strike with Brady's Fault.

The composite thermal anomaly is so intense that it was not necessary to obtain thermal conductivity data on cores or cuttings for heat flow calculations. A few thermal conductivity measurements were made, but they played no part in the discovery of the Desert Peak geothermal field.

Shallow temperature-gradient holes outlined the Desert Peak thermal anomaly and led ultimately to the discovery of the Desert Peak geothermal reservoir. No other exploration tool played a part in locating the thermal anomaly. Without the direct physical evidence provided by the shallow temperature-gradient holes it is likely that the geothermal field would have remained undiscovered.

The Desert Peak area was not one of the original KGRA's; however, simultaneous filings by Union and Phillips during the initial lease applications period in January 1974 created a large KGRA in the area. Due to KGRA designation, geothermal leases on Federal land in the area could be obtained only by competitive sealed bidding.

## ROVING DIPOLE ELECTRICAL RESISTIVITY SURVEY

During the latter stages of the shallow temperature-gradient program a roving dipole resistivity reconnaissance survey was run over the entire thermal anomaly by an independent contractor. In addition, ten depth soundings were made to provide more detailed information on lateral and vertical resistivity variations.

Two plates from this survey are included as plates 4 and 5, an apparent resistivity anomaly map and a total-field apparent conductance map. There were six dipole



source locations with an average of 41 receiver locations per dipole source, for a total of 245 locations. Galvanized pipes in the temperature-gradient holes were used as source electrodes.

It is not possible to contour the total-field resistivity values determined from measurement for all sources on one detailed contour map. Instead, a general map (pl. 4) was constructed to outline the conductive areas. This map was prepared by superimposing the 5 ohm-meter contours from the six individual total-field apparent resistivity maps. Therefore, the boundaries shown are not well defined. The conductive areas are further weighted to show areas interpreted to have apparent total-field resistivities of 5 ohm meters or less to depths greater than 5000 feet. The contrast in total-field apparent resistivity is fairly low. Most apparent resistivities are less than 20 ohm meters and only four data points exceed 30 ohm meters.

The total-field apparent conductance map (pl. 5) is shown because "it permits integration of the conductance values obtained from all of the separate sources onto one map, thus providing a continuous pattern of conductance changes in the area . . . and is less affected by near-surface resistivity effects in roving dipole surveys" (Pritchard and Meidav, 1974). Although there is some shifting and splitting of anomalies on these two maps, they generally show good agreement. On plate 5 two areas of uniform conductance are shown. These areas represent normal conductance for the region.

There are eleven conductive anomalies shown on plate 5 in addition to the shallow temperature gradient contours from plate 1. The conductive anomalies appear to be evenly and randomly spread both within and outside the thermal anomaly. The conductive anomalies outside the thermal anomaly probably do not reflect geothermal processes. Only the two largest conductive anomalies within the thermal anomaly could be related to geothermal processes. The large eastern anomaly was not considered significant because it trends directly across the temperature-gradient contours and lies outside the hotter parts of the thermal anomaly. The large western anomaly was considered the most significant, but the presence of fine-grained Tertiary and Quaternary sediments in this area made even this anomaly suspect. There is a fair correlation between the 30°F/100 feet contour and the large western conductive anomaly on plate 5. The significance of this correlation is discussed in the section of this report on the near-surface thermal aquifers.

The roving dipole survey was run because it was believed to be a cost-effective reconnaissance tool which could rapidly evaluate large areas. However, recent work has demonstrated that roving dipole surveys are generally ineffective in locating conductive zones (Dey and Morrison, 1977). The roving dipole survey at Desert Peak did not detect the geothermal reservoir and was not used to locate the producing wells.

### DESERT PEAK WELL 29-1

Early in 1974 the decision was made to drill a deep geothermal test in the SE/4 S29, T22N, R27E, which is in the most intense part of the Desert Peak thermal

anomaly. It was optimistically felt that drilling anywhere near the heart of the thermal anomaly would lead to a successful test. The well 29-1 site also lay within one of the low resistivity anomalies outlined by the roving dipole survey (pl. 5), although this was not a major factor in site selection.

Land status was another major factor in site location, as nearly all odd-numbered sections in the area are owned by the Southern Pacific Land Company. All holes drilled by Phillips since 1973 in the Desert Peak area have been located on Southern Pacific Land Company lands, thus minimizing Federal paperwork and associated delays. Geochemistry played no part in locating well 29-1; neither did geology, since there are no outcrops or obvious geological structures in the area. Well 29-1 was located near the heart of the thermal anomaly and on private land; the outlook for the well was optimistic.

The subsurface geology in the area was for the most part unknown. The well was expected to penetrate an unknown thickness of late Tertiary and Quaternary sediments and an unknown thickness of Tertiary volcanic rocks ranging from basalt to rhyolite. It was not known if the well would reach Mesozoic metamorphic rocks believed to underlie the Tertiary volcanic rocks or if intrusive rocks would be present at depth.

Well 29-1 was spudded on April 3, 1974, and drilled to a depth of 7662 feet. The rig was released on May 18, 1974. The well did not intersect a geothermal reservoir. No significant lost-circulation problems occurred during drilling, and the well failed to flow when the drilling mud in the well was displaced by nitrogen.

A lithologic log of well 29-1 is shown on figure 7. The contacts on the lithologic logs for the deep wells at Desert Peak are based entirely on geophysical borehole logs which were run from the Kelly bushing, located 23 feet above ground level. Any detailed analysis of the deep wells should include this 23-foot difference. Also, all rock names with a chemical connotation (for example, rhyolite) are derived from the gamma logs. Only a few thin sections have been made from the cuttings and no chemical analyses have been performed. The well penetrated the expected sequence of rocks and provided no lithologic surprises. The top 180 feet consist of Quaternary alluvium. Between 180 and 700 feet generally fine-grained late Tertiary sedimentary rocks are present. These rocks are diatomites, tuffaceous sedimentary rocks, siltstones, and sandstones of the Pliocene Truckee Formation. Some sedimentary rocks of the Desert Peak Formation may be present in the bottom part of this interval. At 700 feet the lithology changes from fine-grained sedimentary rocks to Pliocene and (or) Miocene andesitic and basaltic rocks of the Chloropagus Formation (Axelrod, 1956; Hiner, 1979). In well 29-1 the Chloropagus Formation is 2610 feet thick with the bottom contact at a depth of 3310 feet. Aside from a 140-foot-thick lens of sand and shale between 2590 and 2730 feet and some interbedded lacustrine units between 3020 and 3310 feet, the Chloropagus Formation consists entirely of basalt, basaltic andesite, and andesite flows. These rocks crop out extensively in the Hot Springs Mountains; however, the outcrops are discontinuous and highly faulted.

collar  
elevation: 4240 feet

TERTIARY

feet below Kelly bushing (ground level +23 feet)

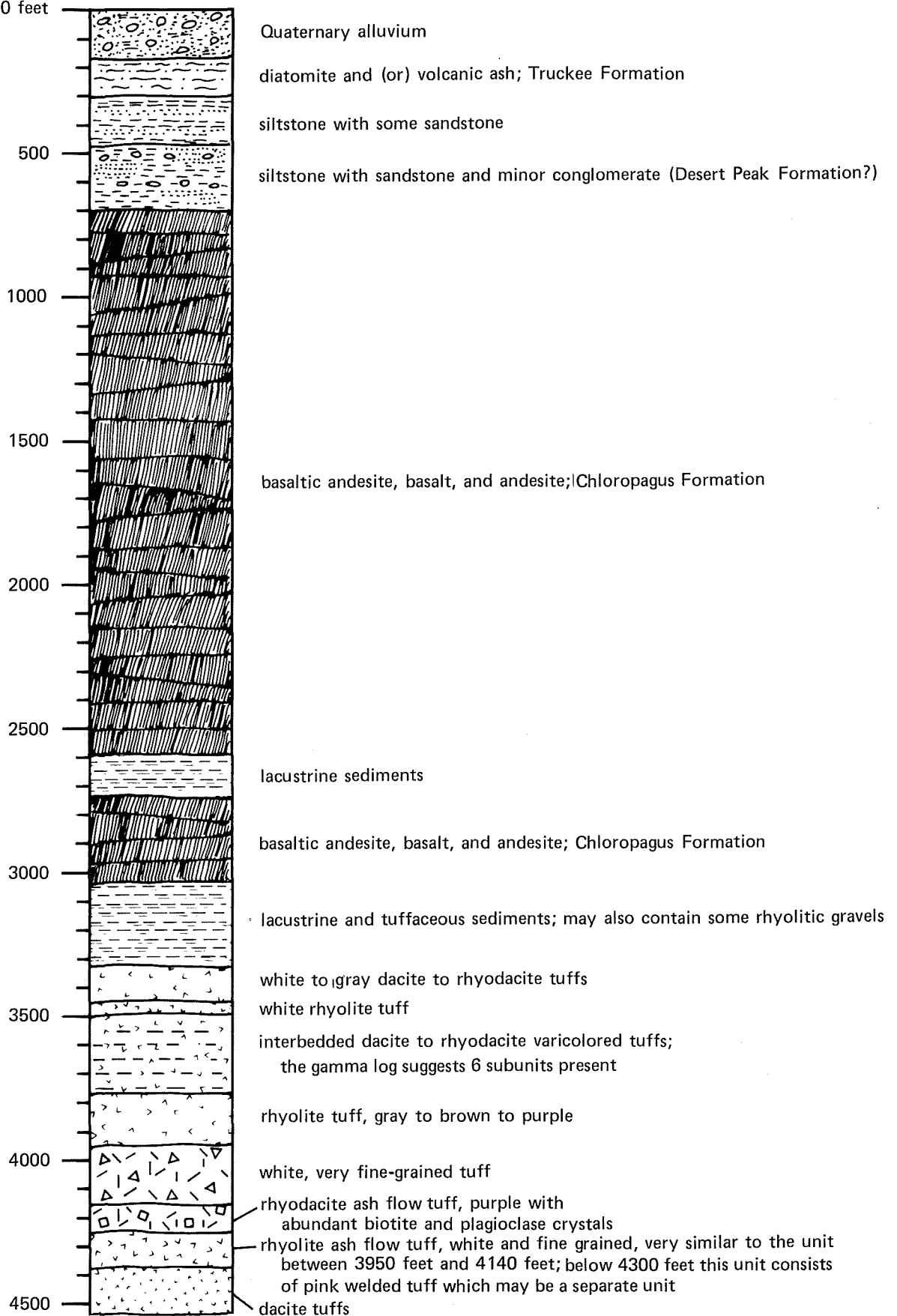

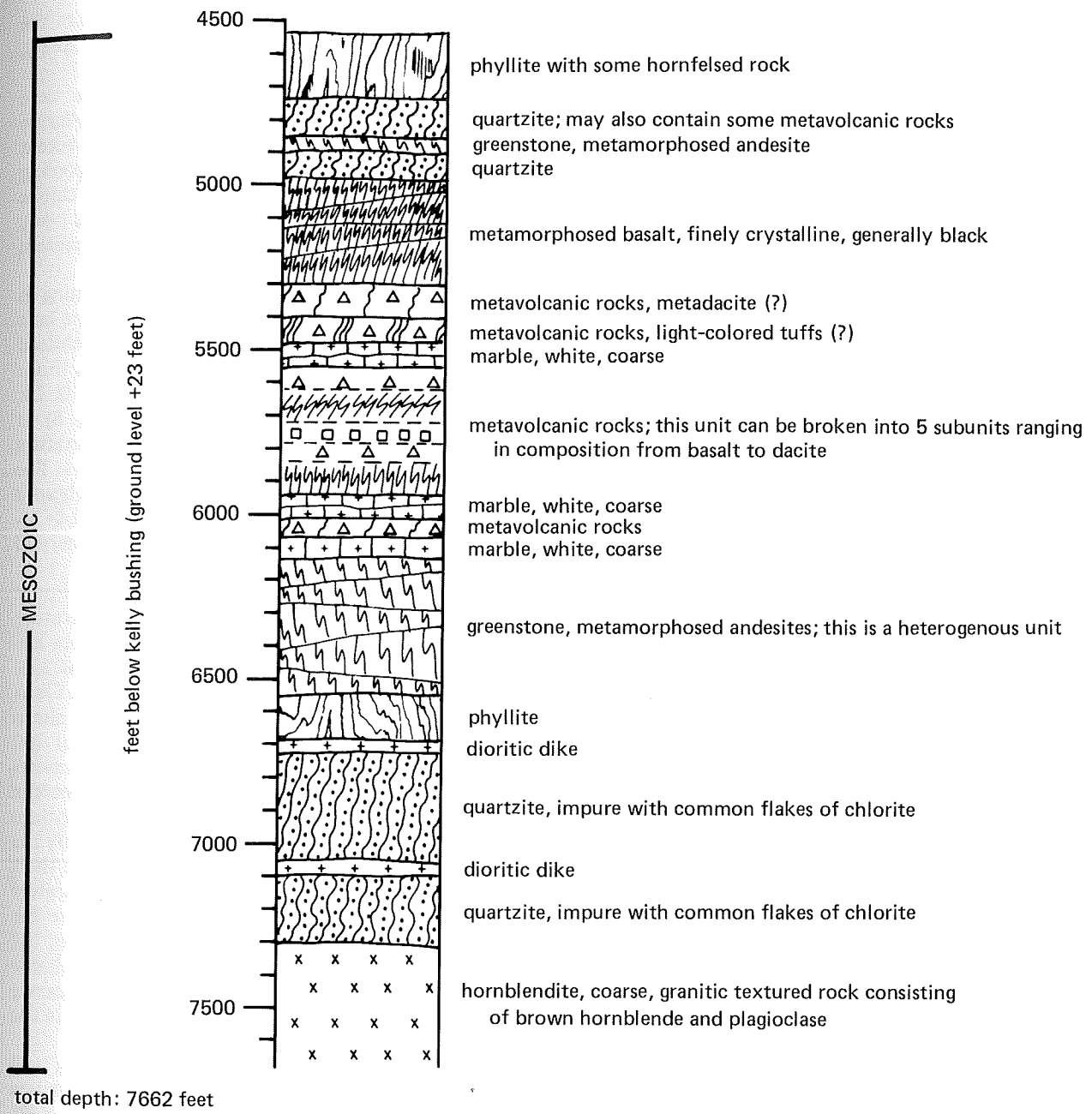

location: SE/4 S29, T22N, R27E  
Churchill County, Nevada  
started: April 13, 1974  
completed: May 18, 1974

FIGURE 7. Lithologic log of Desert Peak well 29-1.

At 3310 feet the rocks abruptly change from basaltic to rhyolitic. The rhyolitic unit extends from 3310 feet to 4535 feet, a thickness of 1225 feet. These rhyolitic rocks are extensive in Churchill County (Willden and Speed, 1974) and in western Nevada (Stewart, 1980). In Churchill County the unit as a whole is unnamed but is probably partly correlative with individual rhyolitic units described by Proffett and Proffett (1976) and Bingler (1978) to the south and southwest of Churchill County. In well 29-1 the unit consists of 10 to 12 ash-flow tuffs.

Small outcrops of this rhyolitic unit are present in the northern part of the Hot Springs Mountains. However, the outcrops are discontinuous and only a small part of the section appears to be exposed.

At 4535 feet in well 29-1 Mesozoic metamorphic rocks were encountered, and they comprise a complex sequence of phyllite, quartzite, marble, and both mafic and siliceous metavolcanic rocks. On figure 7 this unit appears to consist of many thin members but whether this is due to stratigraphy or structural complications is not known. The Mesozoic section is cut by dikes of dioritic rock and intruded by a massive hornblendite. The thickness of the Mesozoic metamorphic rocks in well 29-1 is 2755 feet. Either a large thickness of the Mesozoic section has been removed by the intrusive, or the intrusive is sill-like in form with more strata beneath it.

Although pre-Tertiary rocks are exposed in the nearby Truckee, Trinity, and West Humboldt Ranges, none are exposed in the Hot Springs Mountains. Willden and Speed (1974) divided exposed pre-Tertiary rocks into three units which were tentatively assigned a Triassic and (or) Jurassic age. However, the oldest units could possibly be Permian. These rocks will be simply referred to as Mesozoic or pre-Tertiary in this report.

Well 29-1 bottomed in a hornblendite intrusive. The hornblendite was first encountered at a depth of 7290 feet and a core was taken between depths of 7656 and 7662 feet. The hornblendite is a slightly altered, coarse-grained rock consisting principally of brown basaltic hornblende and plagioclase with minor magnetite and associated trace minerals. No quartz, biotite, or potassium feldspar is present. This rock is clearly basaltic in composition and apparently crystallized under relatively high water pressure to produce hornblende instead of pyroxene (Hyndman, 1972). It is unlikely that this rock is a metamorphic amphibolite, since no metamorphic texture is present in the core.

Hornblende and plagioclase separates from the hornblendite were dated by K-Ar methods by the USGS. The hornblende gave a date of 25.5 million years and the plagioclase gave a date of 9.3 million years. Both minerals have unusually high atmospheric argon contents, suggesting alteration has taken place; both minerals are slightly altered in thin section. Also, since this rock sample had a temperature of about 330°F immediately prior to collection, interpretation of the dates is difficult. The plagioclase date of 9.3 m.y. probably has been thermally reset an unknown amount, and the significance of the 25.5 m.y. hornblende date is not known. This hornblendite has a chemical composition quite similar to some of the rocks of the large Mesozoic

Humboldt Lopolith (150 m.y.) which is exposed in the Carson Sink area (Willden and Speed, 1974; Speed, 1976).

No zones of intense hydrothermal alteration were noted in well 29-1. Some rocks show slight to moderate alteration, but it may be either the result of recent geothermal processes or it may reflect late-stage cooling processes of the volcanic rocks. Quartz and calcite veinlets are fairly common in well 29-1. Quartz, opal, calcite, fluorite, chlorite, zeolites, and pyrite are present as secondary minerals.

Well 29-1 was not a producer; no tubing was hung in the hole and no casing or liners were placed in the hole below a depth of 775 feet. Before the rig was released logs were run on May 11, 12, and 13, 1974. Four temperature surveys were run at intervals of 6, 10, 20, and 35½ hours after mud circulation ceased (fig. 8). It was believed that an accurate equilibrium temperature profile could be calculated from these four surveys. The temperature profiles do show the temperature rebound in the hole, but they give a misleading profile when attempts are made to extrapolate the profile to thermal equilibrium.

On May 27, 1974, fifteen days after the initial temperature surveys were run, another temperature survey was performed (fig. 8). The uncased hole apparently had become blocked at 4400 feet, as the tool could be lowered no farther. This May 27th profile is greatly different than the initial profiles as a sharp temperature reversal had developed at a depth of 700 feet. Consequently, additional temperature surveys were run at later dates; however, the well had become inaccessible below 3240 feet and no equilibrium temperatures are available below this depth. If only the initial temperature surveys had been run the true thermal structure in well 29-1 would not be accurately known. The initial temperature surveys do show the earliest stages of the formation of the reversal, but the period of time covered is not sufficient to permit reliable extrapolation to equilibrium. Without a fairly accurate equilibrium temperature profile, later exploration in the area would have been less effective.

An estimated equilibrium temperature profile of well 29-1 is shown on figure 8 and plate 6. This profile is a composite of three different profiles, and below 4400 feet it is simply an estimate based on extrapolation of the initial profiles (Blackwell, 1975). Since the three different profiles varied by as much as 10°F from each other, the shown profile is not highly accurate. This profile can be broken into three distinct segments. From 0 to 700 feet there is a high linear temperature gradient averaging 25°F/100 feet. From 700 to about 1700 feet the temperature gradient is reversed and the temperature decreases about 50°F in this interval. Below about 1700 feet the temperature gradient is again positive but quite low. Near the bottom of the hole the temperature gradient is believed to be 1°F/100 feet or less. Since thermal conductivity of the rocks increases with depth (Blackwell, 1975) while the temperature gradient decreases, the heat flow remains essentially the same below 1700 feet. Blackwell (1975) has calculated a heat flow of 2.6  $\mu\text{cal}/\text{cm}^2/\text{sec}$  between depths of 2500 and 4600 feet. The most reliable thermal gradients and

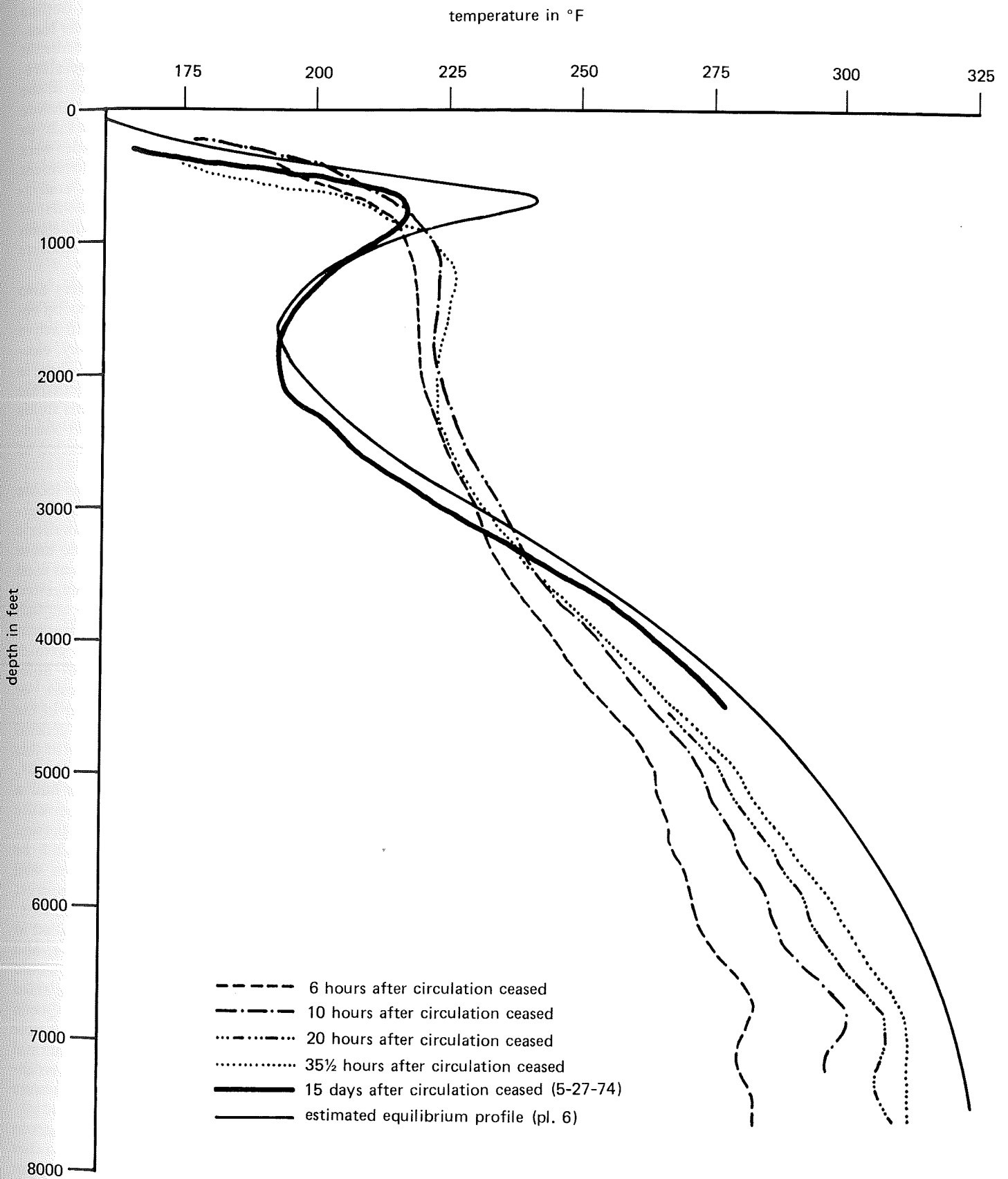

FIGURE 8. Temperature profiles of Desert Peak well 29-1.

thermal conductivities (from cuttings) are present in this interval. This is about 30% above the average for the Basin and Range physiographic province. There is no evidence for convective transfer of heat below 1700 feet. The conductive temperature profile is additional evidence that well 29-1 did not intersect a geothermal reservoir.

The temperature reversal at 700 feet was initially believed to result from a thin subhorizontal thermal aquifer less than 10 feet thick. It was initially assumed that the area is at thermal equilibrium. If so, the only way to maintain the negative temperature gradient between 700 and 1700 feet would be by movement of cooler water through the area below the thermal aquifer. Because the temperature profile is smooth in the interval between 700 and 1700 feet it is unlikely that there is movement of cooler water below the aquifer. A dynamic system with both cool and warm waters moving would not produce such a smooth, regular temperature profile. Also, in this desert basin there is no identifiable source for rapidly moving, laterally flowing cool water.

Blackwell (1975) and Ziagos and Blackwell (1981) have suggested a nonequilibrium thermal model which closely fits the equilibrium temperature profile. In this model a thermal aquifer is assumed to be present at 700 feet and the temperature decrease below 700 feet is the result of the area not having attained thermal equilibrium. The thermal aquifer became active on the order of several thousand years ago and is still warming the underlying rocks. This interpretation is compatible with the smoothness of the equilibrium temperature profile. With time the temperature reversal should be replaced by a linear temperature profile with a low thermal gradient, assuming the thermal aquifer remains active.

The temperature reversal at 700 feet is located at the contact between overlying fine-grained sediments and the basalts of the Chloropagus Formation. Reservoir fluids apparently rise from depth through fractures or faults in the basalts, hit the impervious sediments which act as a cap, and flow either laterally along the contact or in the top few feet of the basalt. At the site of well 29-1 the aquifer must have limited permeability as no lost-circulation problems were encountered when the aquifer was penetrated. No evidence of this aquifer was detected in the cuttings; therefore, the significance of this contact was realized only after the hole had approached thermal equilibrium.

Although well 29-1 is correctly regarded as a commercial failure, it provided extremely useful information on the thermal structure, hydrology, and stratigraphy of the area. Analysis of data from this well made it possible to develop and use exploration tools and techniques suited to previously unknown conditions and problems in the area.

### **DESERT PEAK STRATIGRAPHIC TESTS ONE THROUGH FIVE**

With the discovery of the near-surface thermal aquifer in well 29-1 at a depth of 700 feet, it was obvious

that the shallow temperature-gradient holes, which had outlined the thermal anomaly so well, did not outline the reservoir and could not be trusted to pick the location for another deep test. After well 29-1 was drilled it was realized that four of the shallow temperature-gradient holes, no. 1, 11, 42, and 44, bottomed in the same or similar thermal aquifers as did well 29-1. Before well 29-1 was drilled the temperature reversals or isothermal sections near the bottoms of these holes were believed to be caused by local thermal water movement along faults. After the data from well 29-1 were analyzed, at least the area characterized by gradients of 20°F/100 feet or greater was suspected to be underlain at shallow depths by the same or similar aquifers (Blackwell, 1975).

The discovery and inference of these aquifers also meant that the roving dipole survey needed to be re-evaluated and used with considerable caution. In active electrical surveys such as the roving dipole survey, electricity from the surface is put into the ground. There is no reason to expect the electrical current to penetrate through this hot, shallow aquifer, which contains fluids with a salinity of 7000 to 8000 ppm. The aquifer short-circuits the electrical survey and prevents delineation of any deeper electrical features.

Only two exploration tools had the potential to locate a geothermal reservoir possibly lying beneath the thermal aquifer: deeper drilling and magnetotelluric methods. Deeper drilling was thought to be the more reliable tool, though far more expensive, and it was used first. The temperature profile from well 29-1 suggested that a hole 2000 feet deep would extend far enough below the aquifer to give a positive thermal gradient which hopefully could be extrapolated to greater depths. Next, the location for these 2000-foot holes (hereafter referred to as either strat. tests or stratigraphic tests) had to be determined. Water in the thermal aquifer was suspected to flow in a general southerly direction near well 29-1. The evidence for this came from shallow temperature-gradient hole no. 37, located ½ mile north of well 29-1. This hole had a bottom-hole temperature of 291°F and a temperature gradient of 64°F/100 feet. If the aquifer were present beneath the bottom of hole no. 37 it would be significantly hotter than the 243°F measured in well 29-1. The aquifer would be hotter nearer its source; therefore, the source appeared to lie north of well 29-1.

Early in 1976 three stratigraphic tests were drilled at Desert Peak. Two were located north of well 29-1, and hopefully one or both of these stratigraphic tests would be located near the source of the aquifer. The third stratigraphic test was located near the Desert Queen Mine in S7,T22N,R28E. The purpose of this drill hole was to evaluate the northeastern lobe of the thermal anomaly. Data from these three drill holes were so encouraging that two additional stratigraphic tests were drilled shortly thereafter.

In order to keep the cost of these stratigraphic tests as low as possible no cores were obtained and no logs other than temperature logs were run in the wellbore. Neither was any thin section, chemical, or x-ray work performed. Consequently, the lithologic logs from the stratigraphic tests are generalized.

## STRATIGRAPHIC TEST NO. 1

Strat. test no. 1 is located near shallow temperature-gradient hole no. 37 principally because hole no. 37 had such a high bottom-hole temperature and thermal gradient. Hopefully, the 64°F/100 foot gradient would continue to a depth of 500 or 600 feet and possibly would give the base temperature of the geothermal system. There was also some meager geological and geophysical evidence (ground magnetics, gravity, and heat flow) that a northwest-southeast trending structure was located near strat. test no. 1. This structure is discussed in more detail later in this report.

Strat. test no. 1 was drilled between March 6 and 18, 1976, to a depth of 2000 feet. Unconsolidated gravel and clay were the dominant lithologies present to a depth of 120 feet (fig. 9). The rocks are intensely hydrothermally altered between 120 and 250 to 290 feet. There were several lost-circulation zones encountered in this interval. It is surprising that this hot, highly permeable, altered interval does not show up on the temperature profile (pl. 6) as an isothermal zone. The Chloropagus Formation is present between 300 and 2000 feet and contains numerous thin lacustrine intercalations of sandstone and claystone which were not present in well 29-1. The first basaltic material is present at a depth of 45 feet and could be either part of the Chloropagus Formation or one of several younger basalts (pl. 13). The bottom 200 feet of strat. test no. 1 consist of lacustrine sedimentary rocks. It is possible that these are correlative with the sedimentary rocks found near the bottom of the Chloropagus section in well 29-1 (fig. 7).

The equilibrium temperature profile for strat. test no. 1 is shown on plate 6. It has a bottom-hole temperature of 259°F, but the temperature gradient at the bottom of the hole cannot be reliably extrapolated. The profiles for well 29-1 and strat. test no. 1 have a similar shape. In strat. test no. 1 the aquifer was intersected at a depth of 360 feet and has a temperature of 299°F. Below the aquifer a minimum temperature of 257°F is present at a depth of 1750 feet. The temperature decrease below the aquifer is 42°F. Below a depth of 1000 feet strat. test no. 1 and well 29-1 have remarkably parallel temperature profiles, with strat. test no. 1 averaging 63°F hotter than well 29-1 at the same depth. The two wells are about 2600 feet apart; the horizontal temperature gradient between these two holes below 1000 feet is 2.4°F/100 feet. Although 2.4°F/100 feet is not a high vertical temperature gradient, it is an extremely high horizontal gradient. This gradient suggests that strat. test no. 1 is located a short distance south of a near-surface and steeply dipping thermal boundary.

The thermal aquifer in strat. test no. 1 occurs in the Chloropagus Formation at a depth of 360 feet. The aquifer appears to be capped by a thin clay unit interbedded within the basalt flows. Apparently there are a number of relatively local caps for this aquifer instead of one widespread lithologic cap. Strat. test no. 1 and well 29-1 showed that the water in the thermal aquifer is indeed flowing in a southerly direction.

## STRATIGRAPHIC TEST NO. 2

Strat. test no. 2 was drilled between March 19 and 28, 1976, to a depth of 1293 feet. This hole was terminated short of 2000 feet due to severe lost-circulation problems and high subsurface temperatures. The drilling mud reached a temperature of 180°F during drilling. This hole was located northeast of strat. test no. 1 in the SE/4 S21, T22N, R37E near hole no. 39, which has a temperature gradient of 44°F/100 feet. Data were also needed from this area to evaluate the surrounding Federal land and to provide a basis for future bids for geothermal leases.

The top 30 feet of strat. test no. 2 are composed of Quaternary sand and gravel. From 30 to 705 feet the rocks are fine-grained, upper Tertiary lacustrine units of the Truckee and (or) Desert Peak Formations (fig. 10). The underlying basalts and andesites of the Chloropagus Formation are only 520 feet thick and contain only a few minor lacustrine intervals. In well 29-1 the Chloropagus Formation is 2610 feet thick. This 2090-foot difference in thickness over a horizontal distance of 1.4 miles was unexpected. At 1225 feet the top of the rhyolitic unit is present, and circulation was completely lost during drilling in this unit. This is the only hole to date at Desert Peak which has encountered severe lost-circulation problems in the rhyolitic unit. Strat. test no. 2 bottomed in this unit.

The equilibrium temperature profile for strat. test no. 2 is shown on plate 6. The bottom-hole temperature is 369°F and the temperature gradient at the bottom of the hole is approximately 16°F/100 feet. The temperature profile is characterized by a low temperature-gradient interval sandwiched between much higher temperature gradients. This low-gradient interval corresponds well with the Chloropagus Formation.

Thermal conductivity variations can have a great influence on the shape of temperature profiles and their subsequent interpretation. Heat flow is the product of the temperature gradient and the thermal conductivity of the surrounding rocks. In many cases temperature profiles similar to those from strat. test no. 2 can originate from thermal conductivity variance with lithology simply because different strata have different thermal conductivities. If a stratum with a relatively high thermal conductivity is sandwiched between strata with much lower thermal conductivities, the middle stratum should show a lower thermal gradient, assuming the heat flow is constant.

However, in the case of strat. test no. 2, the large gradient decrease within the Chloropagus Formation is believed to reflect lateral conductive and (or) convective movement of heat. No thermal conductivity measurements have been obtained for strat. test no. 2; therefore, accurate heat flow calculations are not available. In the absence of the conductivity measurements, only a small part of the very large decrease in thermal gradient is attributable to variations in thermal conductivity. Strat. test no. 7 penetrated a very similar stratigraphic sequence, yet the profile is linear throughout the hole (pl. 6). This indicates that the

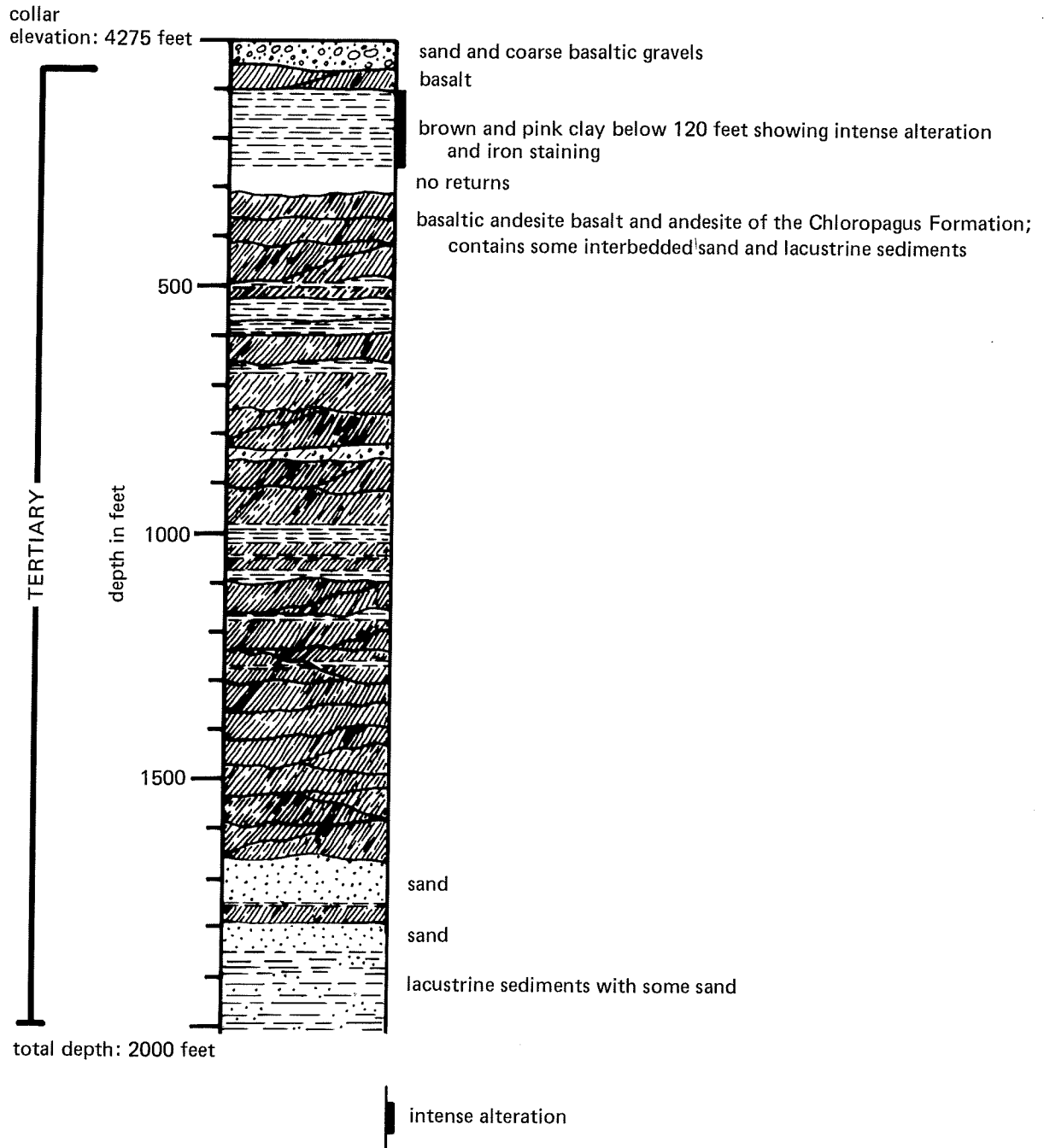

location: SE/4 NE/4 S29, T22N, R27E  
Churchill County, Nevada  
started: March 6, 1976  
completed: March 18, 1976

FIGURE 9. Lithologic log of Desert Peak stratigraphic test no. 1.



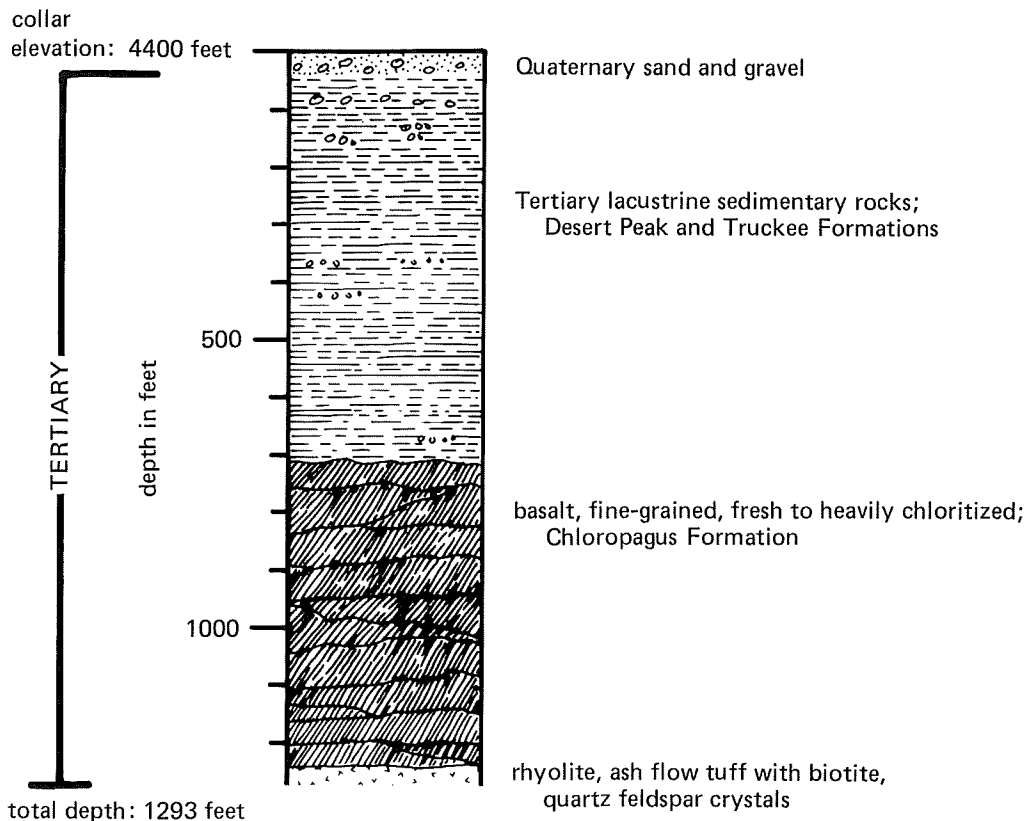

location: SE/4 SE/4 S21, T22N, R27E  
Churchill County, Nevada  
started: March 19, 1976  
completed: March 28, 1976

FIGURE 10. Lithologic log of Desert Peak stratigraphic test no. 2.

thermal conductivity of the Chloropagus Formation does not differ significantly from the overlying and underlying units. Evidence for lateral movement of heat comes from a comparison of the temperature profiles of well B21-1 and strat. test no. 2 (pl. 6). The holes are located only 400 feet apart, but they show greatly different temperature profiles from 650 to 1225 feet in depth. The Chloropagus Formation is present between depths of 705 and 1225 feet.

Strat. test no. 2 was a very encouraging hole and was a major factor in the decision to continue work in the area.

### STRATIGRAPHIC TEST NO. 3

Strat. test no. 3 was drilled between March 29 and April 11, 1976, to a depth of 1395 feet. The purpose of this hole was to gain a better understanding of the northeastern lobe of the thermal anomaly. This lobe was suspected to be caused by a near-surface thermal aquifer flowing in an easterly direction. Therefore, the hole was located at the far western edge of the lobe in hope of locating the source of the aquifer. It is also situated in what was interpreted as one of the most favorable resistivity anomalies in the Desert Peak area (Pritchard and Meidav, 1974).

A lithologic log from strat. test no. 3 is shown in figure 11. The cuttings from this hole were often finely ground by the drill bit, and lithologic interpretations may not be accurate.

If the lithologic log is correct, this stratigraphy differs from the stratigraphy encountered in all the other deeper holes in the Desert Peak area. The rhyolitic section is apparently missing. The basalts and lacustrine sediments of the Chloropagus Formation are about 280 feet thick and lie directly on what appear to be pre-Tertiary metasedimentary rocks at a depth of 620 feet. Gravity data provide some additional evidence that the Mesozoic rocks may be found at relatively shallow depths in this area.

The equilibrium temperature profile from strat. test no. 3 is shown on plate 6. The bottom-hole temperature is 214°F and the thermal gradient at the bottom of the hole is 4.8°F/100 feet. The profile shows a more or less continuous decrease of the temperature gradient with depth. Similar temperature profiles have been calculated by Nathenson and others (1979) assuming conductive heating of a slab by water moving vertically up a nearby fault. The profile from strat. test no. 3 may result from thermal water rising along a nearby fault, possibly the Desert Queen Fault (pl. 13).

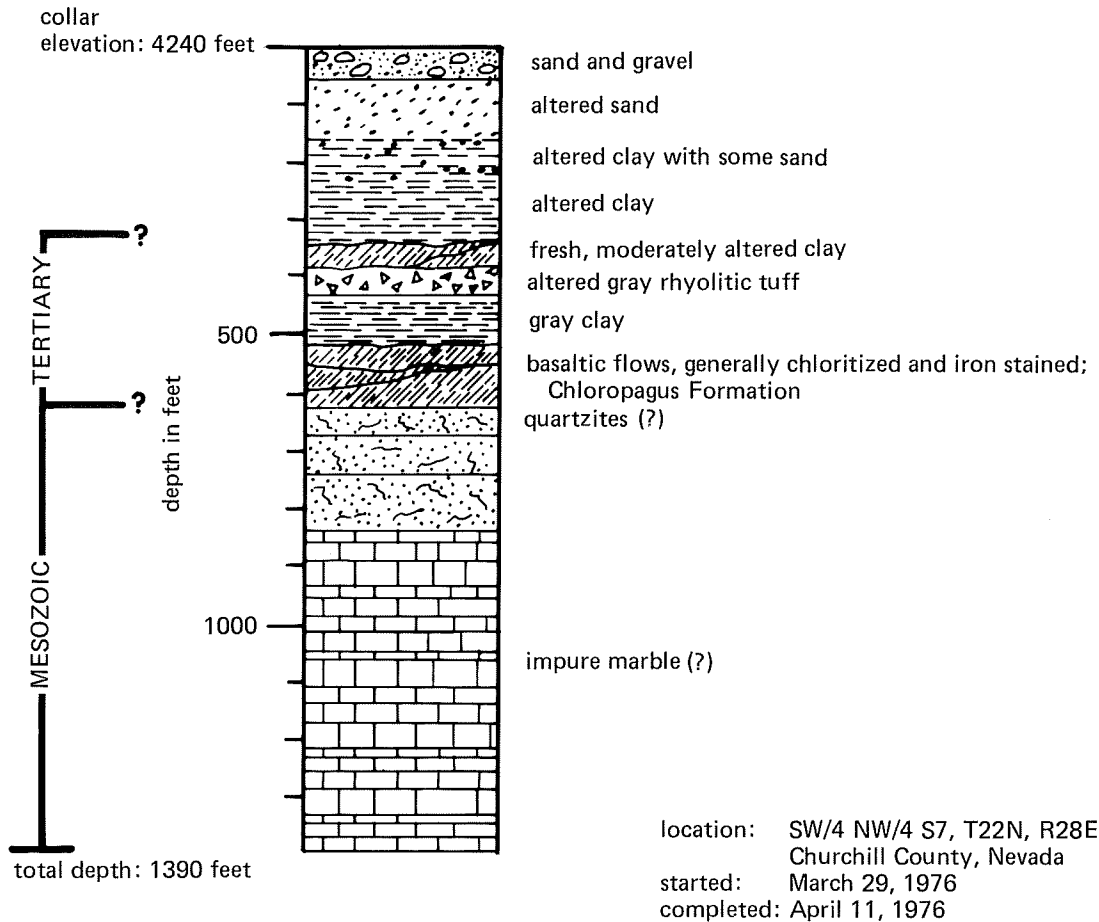

FIGURE 11. Lithologic log of Desert Peak stratigraphic test no. 3.

#### STRATIGRAPHIC TEST NO. 4

Strat. test no. 4 was drilled between April 22 and May 6, 1976, to a depth of 1675 feet. The location was chosen for evaluation of the land between strat. test no. 2 and Brady's Hot Springs. The near-surface thermal anomaly has its long axis in a northwest-southeast direction (pl. 1), and it was suspected that the geothermal reservoir may be similarly elongated. This stratigraphic test is located about ½ mile to the west of the large lineament which runs northeasterly near Green Hill and contains the Desert Peak Fault.

This stratigraphic test was spudded in the Chloropagus Formation and did not reach the underlying rhyolitic rocks (fig. 12). Mafic lava flows predominate. Lacustrine deposits are found between depths of 300 and 400 feet. Between 1390 and 1610 feet a thick sand and gravel unit is present. There is presently no accurate way to estimate the depth to the rhyolitic section in this area.

Strat. test no. 4 has a bottom-hole temperature of 202°F and a bottom-hole thermal gradient of 5.9°F/100 feet. The temperature profile (pl. 6) is linear.

#### STRATIGRAPHIC TEST NO. 5

Strat. test no. 5 was drilled between July 7 and 26, 1976. The purpose of strat. test no. 5 was to prove that

high temperatures in the vicinity of strat. test no. 2 could be areally extensive and to provide a possible alternative site to strat. test no. 2 for a second deep geothermal test well.

The top 50 feet of this hole are composed of Quaternary alluvium (fig. 13). Lacustrine rocks of the Truckee(?) Formation are present between 50 and 200 feet. The samples show intense hydrothermal alteration between 200 and 440 feet, and the original material is unrecognizable. The top of the Chloropagus Formation may be at a depth of 200 feet. The bottom is at 667 feet, resulting in a thickness of 467 feet. The top of the rhyolitic unit was encountered at a depth of 667 feet. About five subunits in the rhyolitic unit appear to be present between 667 and 2000 feet.

A temperature profile of strat. test no. 5 is shown on plate 6. The accuracy of this profile is questionable, but it is shown because it was obtained by the same contractor and equipment as most of the other profiles on plate 6. The bottom-hole temperature is 339°F and the thermal gradient near the bottom of the hole is 9.0°F/100 feet. A temperature survey by Phillips personnel to a depth of 550 feet (fig. 14) shows a substantial difference, as an isothermal section exists between 310 and 460 feet with a temperature of 207°F. The Phillips temperature survey is believed to be more accurate.

This temperature profile is more complex than the temperature profile of any other stratigraphic test at

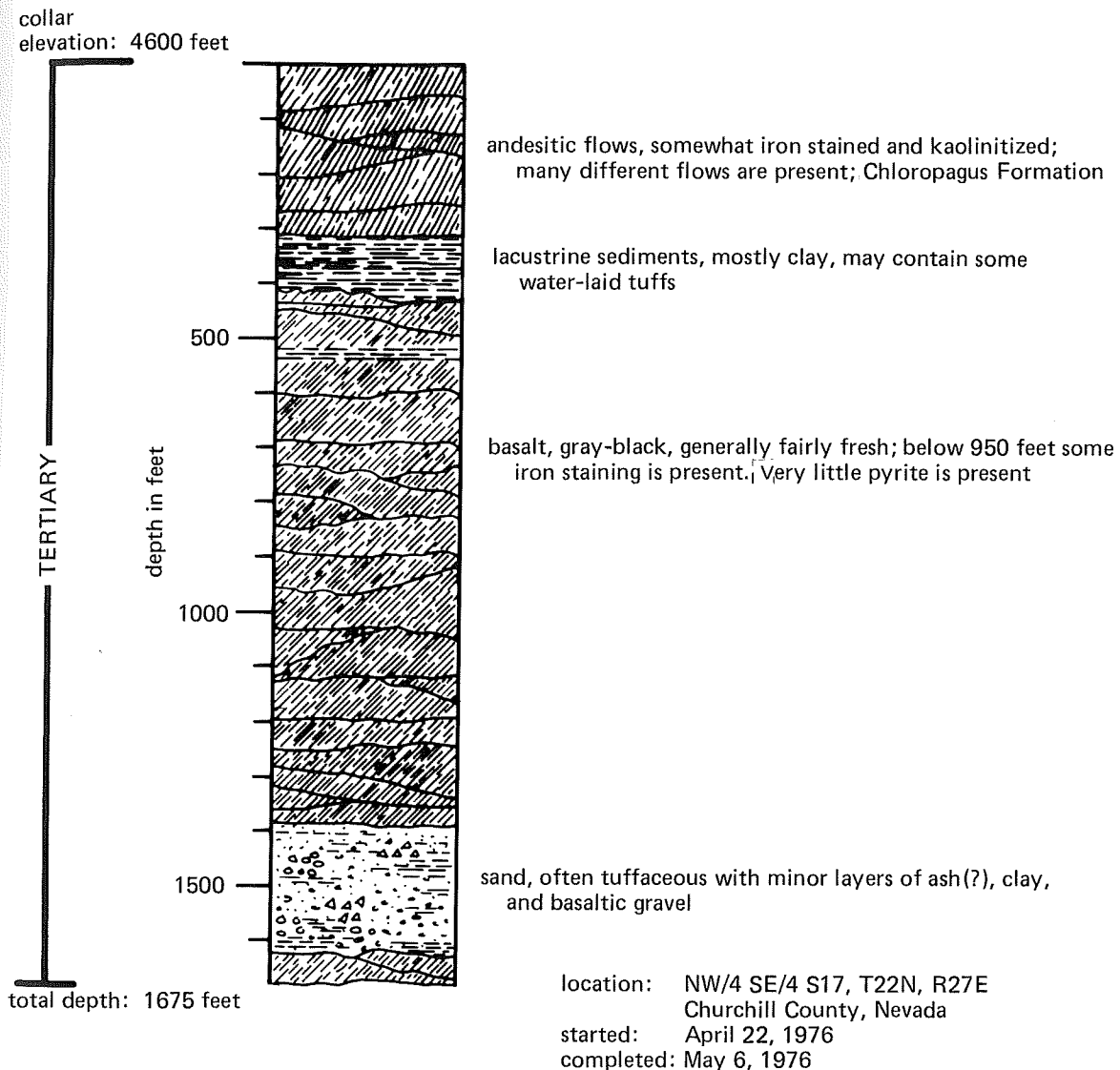
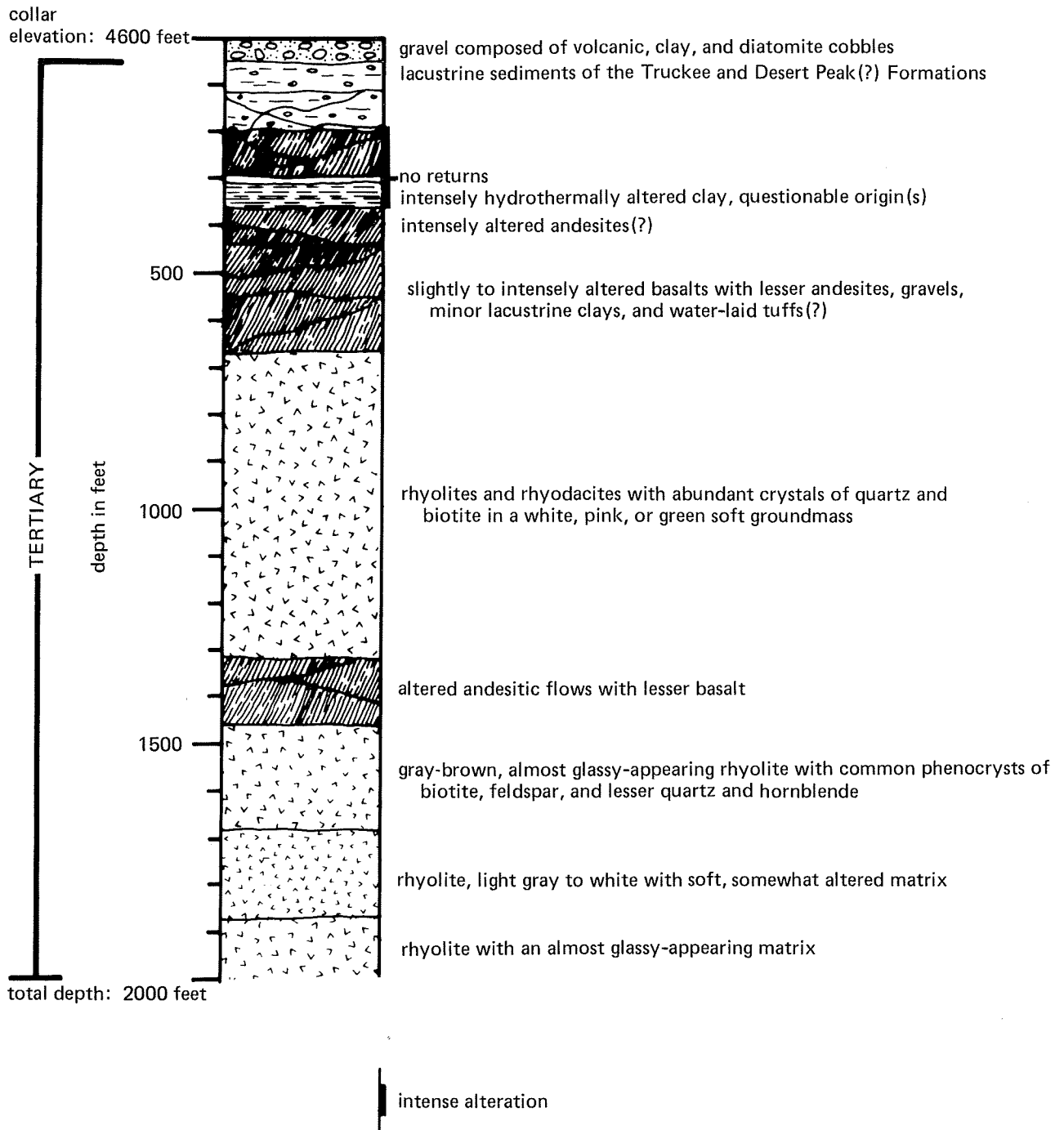

FIGURE 12. Lithologic log of Desert Peak stratigraphic test no. 4.

Desert Peak. The isothermal section in the profile between 310 and 460 feet corresponds with the intensely altered interval, and some lost-circulation zones were encountered while drilling this interval. The temperature Phillips obtained in this interval is at the boiling point, and water-level data from nearby well B21-2 suggest the water level is at a depth of 480 feet. Therefore, this isothermal and altered section probably is the result of a boiling water table. A thermal aquifer is present at a depth of 880 feet and has a temperature of 298°F. The temperature profile is nearly linear between the bottom of the isothermal zone and the aquifer, suggesting this section of the hole has essentially reached a steady-state equilibrium. Below the aquifer there is a 25°F drop before the thermal gradient becomes positive again. The section of hole below the aquifer has not yet reached thermal equilibrium. This aquifer apparently is not the same as the one encountered in well 29-1, yet both appear to have become active recently. The aquifer is located within the rhyolitic unit but no lithologic feature has been identified as a possible caprock.

#### TEMPERATURE CROSS SECTION A-A'

A temperature cross section between well 29-1 and strat. test no. 5 clearly reveals the gross thermal structure in the area (fig. 15). The thermal aquifer present in well 29-1 and strat. test no. 1 is one of the major features on the cross section. The closely spaced isotherms near the surface are largely the result of the thermal aquifers. This cross section shows that the higher isotherms plunge steeply to the southwest between strat. test nos. 1 and 2. The isotherms probably reflect a steeply dipping reservoir boundary, although a fault similar to Brady's Fault in this location cannot be disproved. The isotherms indicate that there is a high horizontal thermal gradient caused by lateral conduction of heat away from the reservoir. The near-surface aquifer has totally hidden this boundary from detection by shallow temperature-gradient holes. This cross section (fig. 15) clearly shows the area near strat. test no. 2 is an obvious location for a second deep geothermal test.



location: NE/4 NE/4 S21, T22N, R27E  
Churchill County, Nevada  
started: July 9, 1976  
completed: July 27, 1976

FIGURE 13. Lithologic log of Desert Peak stratigraphic test no. 5.

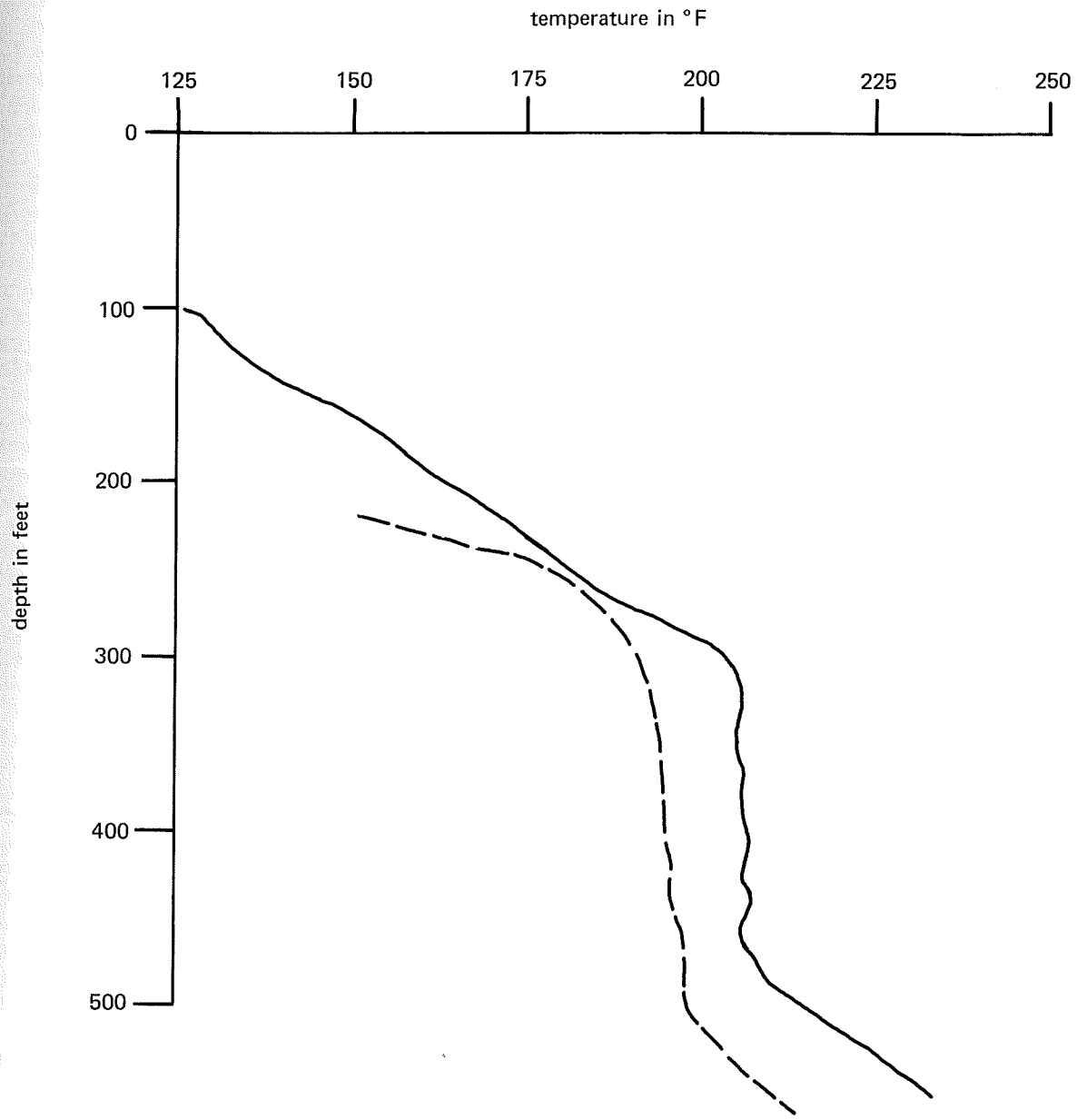

— profile obtained by Phillips personnel  
 - - - profile obtained by independent contractor and shown on plate 6

**FIGURE 14. Temperature profiles of the upper part of Desert Peak stratigraphic test no. 5.**

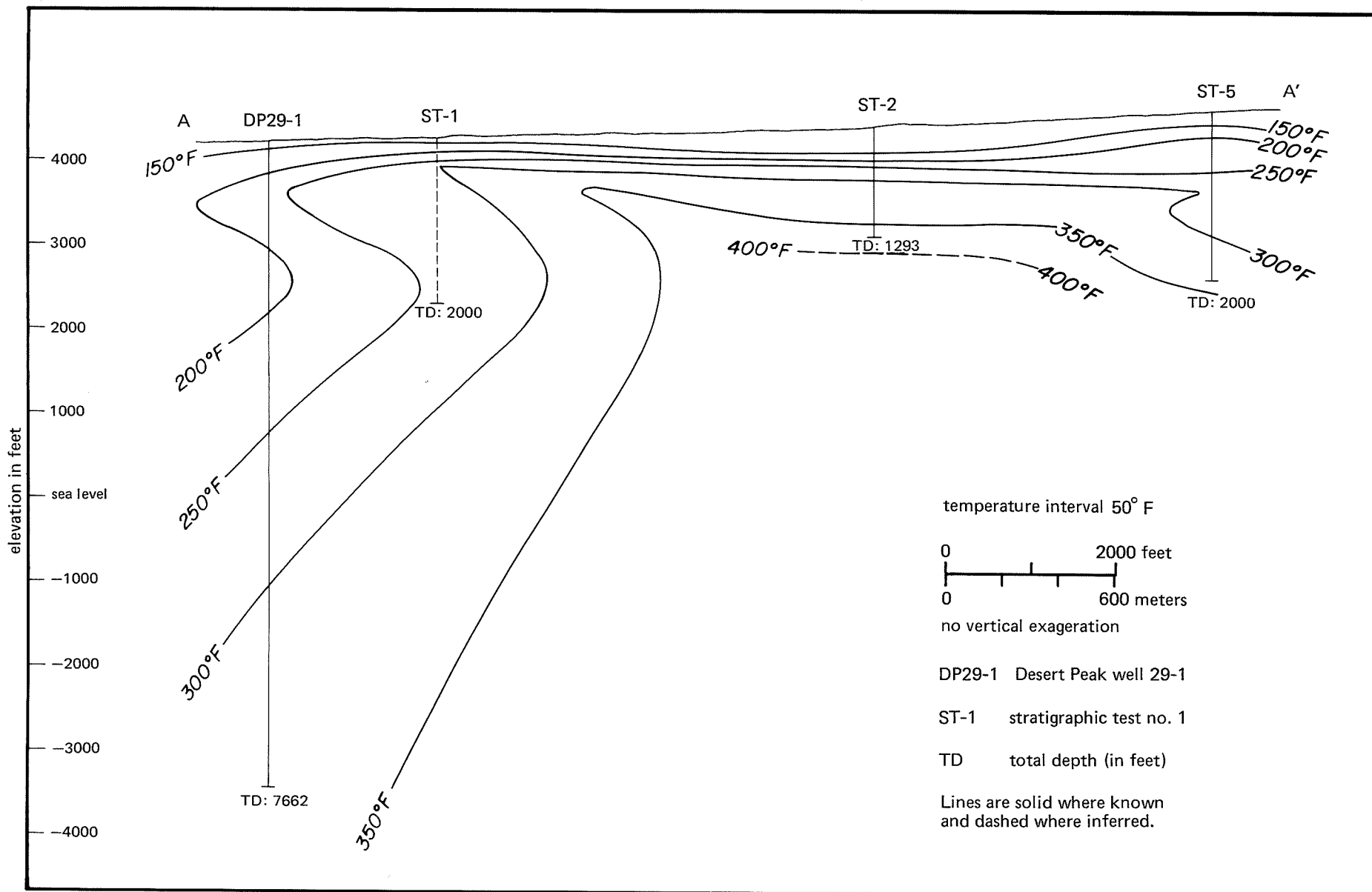

FIGURE 15. Temperature cross section A-A' based on stratigraphic tests (see plates 12 and 13 for location of A-A').

## DESERT PEAK WELL B21-1

Strat. test nos. 2 and 5 proved that geothermal potential at Desert Peak was high enough to warrant a second deep test well. In July 1976 it was decided that well B21-1 would be drilled near strat. test no. 2 to a maximum depth of 6000 feet. Once again the well was located on private land. Geology, geochemistry, and geophysics (other than the temperature-gradient work) played no part in locating well B21-1. Prior to spudding well B21-1 very little was known about the reservoir except that it would be liquid-dominated. Thermal fluids in the shallow aquifers could not originate as steam condensate or from a hot-dry-rock reservoir. The few water samples available were sodium-chloride waters (see the section of this report on geochemistry) which also indicate a liquid-dominated reservoir (White, 1970). Geothermometry suggested temperatures near 400°F, but these geothermometers could have been readjusted to lower temperatures in the aquifers; hopefully the reservoir would be significantly hotter than 400°F. The reservoir host rock was unknown, as was the possible size, depth, and thickness of the reservoir. It was crucial that this well be a commercial producer, as another unsuccessful well would make it virtually impossible to convince management that the area warranted or deserved additional exploration.

Well B21-1 was spudded on October 25, 1976, about 400 feet away from strat. test no. 2. The rig was moved off location on November 18, 1976. Well B21-1 is 4150 feet deep and produces 450,000 lbs per hour of fluid (fig. 16) with a wellhead pressure of 103 psig (pounds per square inch gage). The flow rate was calculated using the lip pressure method described by James (1966). The reservoir temperature in well B21-1 is 406°F.

A lithologic log of well B21-1 is shown on figure 17. Upper Tertiary and Quaternary sediments and sedimentary rocks are present to a depth of 520 feet. Between 250 and 430 feet they are intensely hydrothermally altered. The Chloropagus Formation is present between 520 and 1270 feet, resulting in a thickness of 750 feet. Fresh black basalts are found only between 900 and 1050 feet. The rest of the Chloropagus Formation is composed of generally soft, green basaltic and andesitic flows and (or) tuffs.

In well B21-1 the rhyolitic unit is 1675 feet thick and is found between depths of 1270 and 2945 feet. The rhyolitic unit in this well has a 500-foot-thick sequence of andesitic to dacitic rocks present near the middle of the unit. These intermediate composition rocks are not present in well 29-1.

Mesozoic metamorphic rocks are found below a depth of 2945 feet. In well B21-1 the Mesozoic rocks are predominantly metamorphosed volcanic rocks of intermediate composition which are referred to as greenstone. Between depths of 3740 and 3900 feet a section of limestone and impure quartzite is present. At the base of this unit numerous slickensides and considerable fault gouge were observed in the cuttings, suggesting a fault contact. The Desert Peak geothermal reservoir has productive zones consisting of fractures in the greenstone. In well 29-1 the greenstone accounted for roughly 30% of the Mesozoic section present; in well B21-1 the greenstone comprises more than 80% of the

known Mesozoic section. The stratigraphic and structural relationships between these two greatly different sections have not been resolved. No cores were taken in well B21-1, and it was terminated at 4150 feet because production had been proven and additional drilling would have been difficult, risky, and expensive. Circulation was lost at depths of 3638, 3891, 3970, and 4000 feet. Below 3881 feet the well was drilled with air and water. The well was difficult to control and produced 1800 barrels of water while drilling between 3990 and 4140 feet.

The equilibrium temperature profile of well B21-1 is shown on plate 6. The temperature gradient is 42°F/100 feet to a depth of 480 feet. This interval corresponds to the relatively impervious upper Tertiary and Quaternary sedimentary rocks. Between 560 and 1300 feet the temperature gradient gradually decreases to 0.22°F/100 feet with a slight temperature reversal between 870 and 1060 feet. This type of convex upward temperature profile is usually caused by nearby ascending thermal waters (White, 1973). The long, nearly isothermal section of the profile from 1360 to about 3638 feet is believed to result from lateral conduction of heat from reservoir water ascending a nearby steeply dipping fault. The location of this nearby fault is not precisely known, but evidence for it is discussed later in this report. The isothermal section between 3638 and 4192 feet is interpreted to result from convective movement of water within a network of fractures in the greenstone.

## DESERT PEAK WELL B21-2

Immediately after well B21-1 was determined to be successful plans were made to drill a confirmation well. This well, B21-2, is located on private land 4100 feet north of well B21-1 and about 190 feet from strat. test no. 5. Well B21-2 was spudded on November 23, 1976, and the rig was released on December 20, 1976. The well is 3192 feet deep and produces about 456,000 lbs per hour of fluid with a wellhead pressure of 64 psig (fig. 18). The reservoir temperature in well B21-2 is 392°F, 14°F less than in well B21-1. Production flow tests show both wells to be in the same reservoir.

A lithologic log of well B21-2 is shown on figure 19. The top 260 feet consist of Quaternary and upper Tertiary sediments and sedimentary rocks. Between 260 and 620 feet basalts and andesites of the Chloropagus Formation are present. In nearby strat. test no. 5 the rocks are intensely altered between depths of 200 and 400 feet. This intense alteration is not present in well B21-2. Recent subsurface hydrothermal alteration may be common at Desert Peak but it apparently has a patchy distribution. A deep water table is probably the reason for the lack of hot springs and alteration at the surface. The rhyolitic unit is present at a depth of 620 feet and has a thickness of 2165 feet. The rhyolitic units penetrated by wells B21-1 and B21-2 are grossly similar.

Pre-Tertiary rocks are present below 2785 feet. Well B21-2 penetrated only 407 feet into the Mesozoic section. The first reservoir fracture was encountered at a depth of 2868 feet and no cuttings returned to the surface between 2880 and 3192 feet. Geophysical logs were

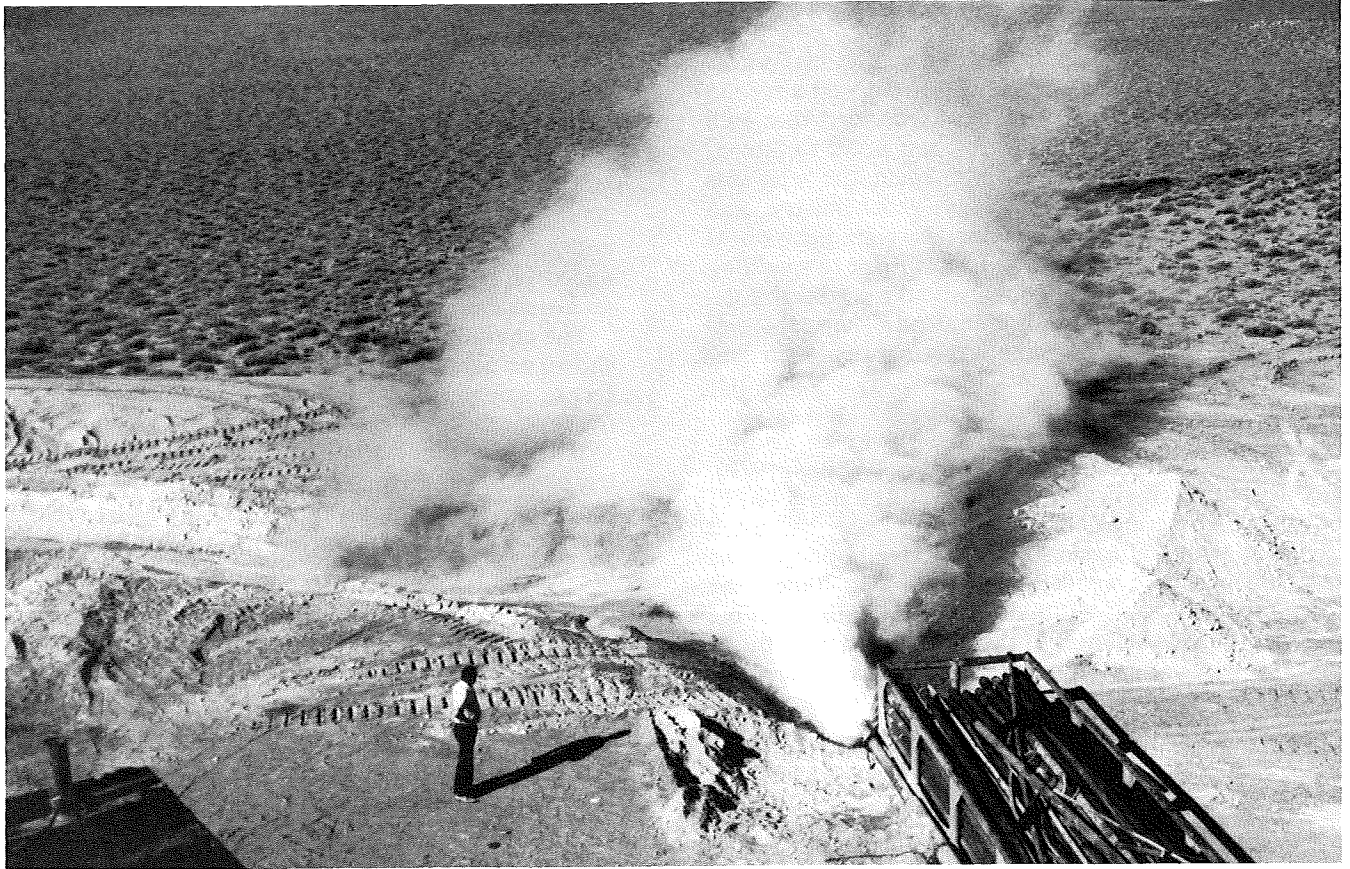

**FIGURE 16. Photographs of Desert Peak well B21-1 flowing. View looking northwest.**

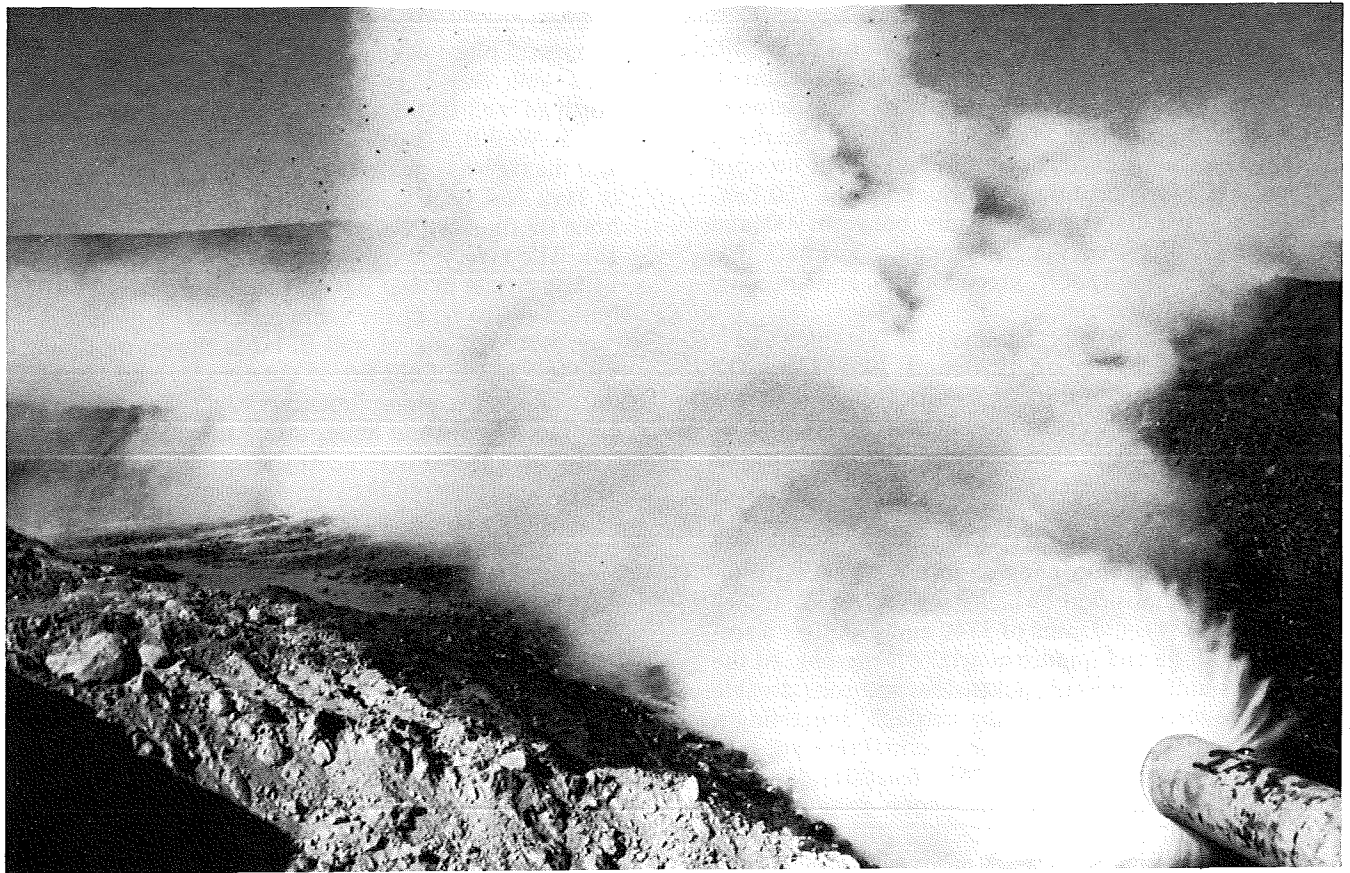



collar elevation: 4410 feet

TERTIARY

MESOZOIC

total depth: 4150 feet

feet below Kelly bushing (ground level +23 feet)

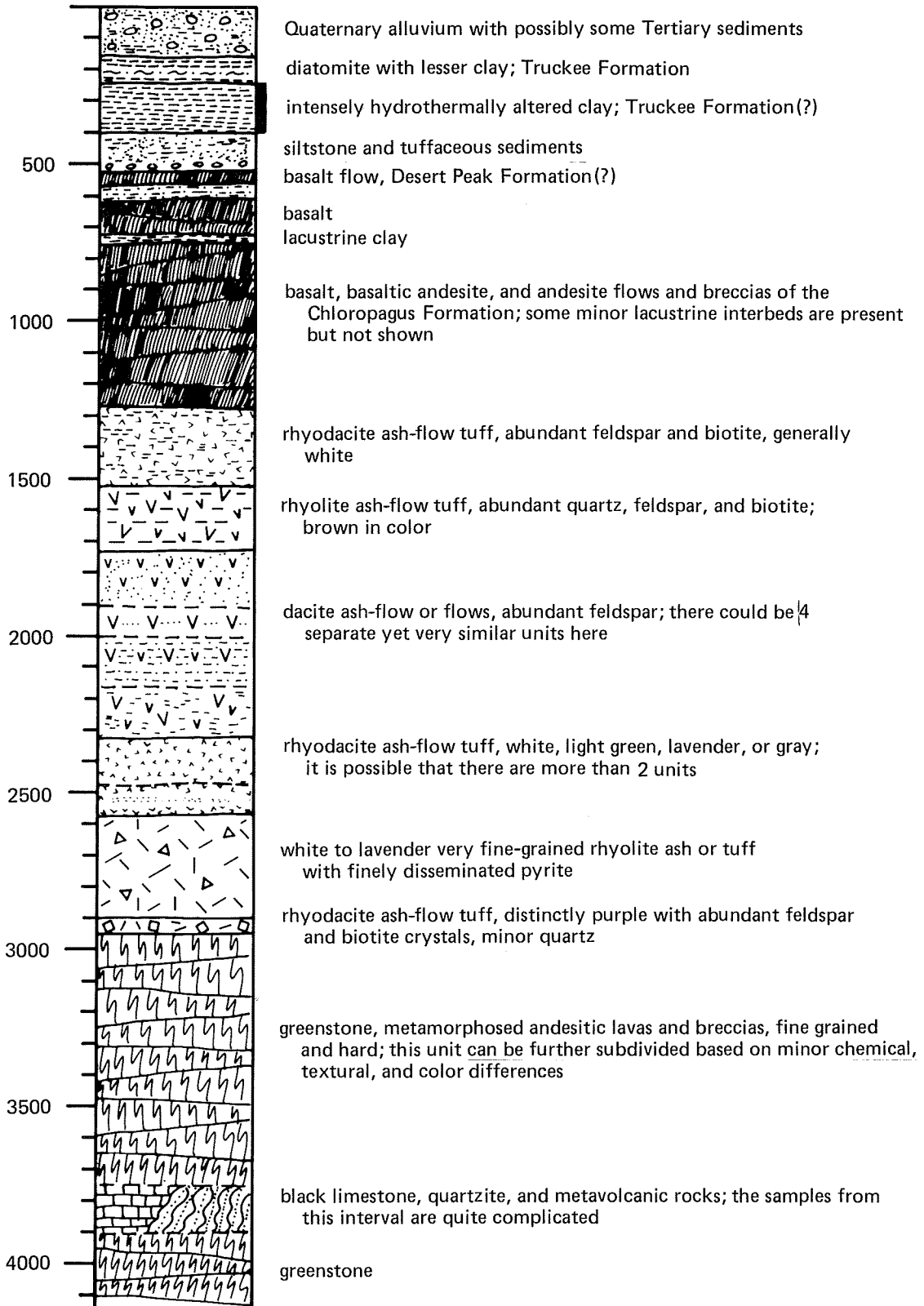

intense alteration

location: SW/4 SE/4 S21, T22N, R27E  
 Churchill County, Nevada  
 started: October 25, 1976  
 completed: November 18, 1976

FIGURE 17. Lithologic log of Desert Peak well B21-1.

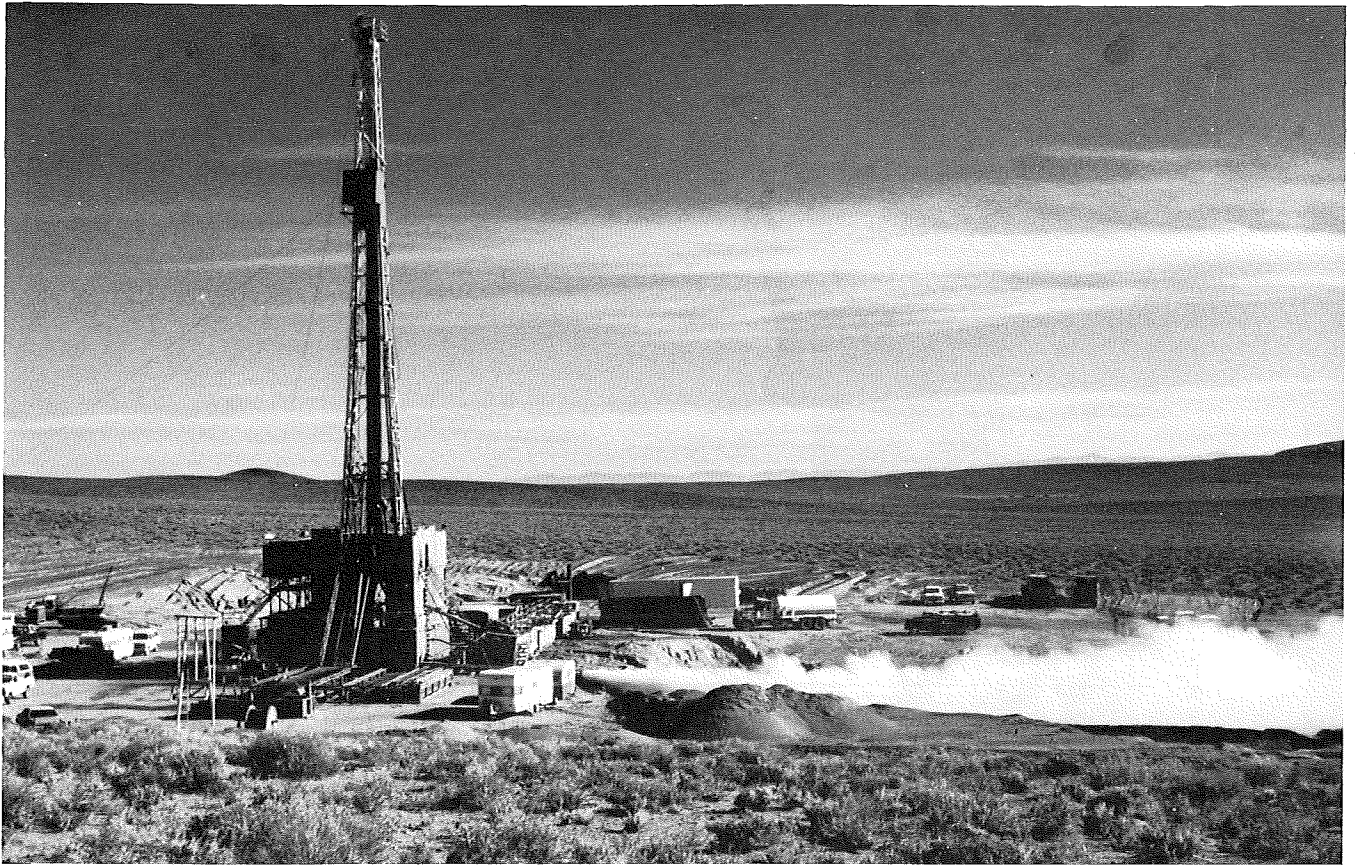

**FIGURE 18.** Photographs of Desert Peak well B21-2 flowing. View looking east.

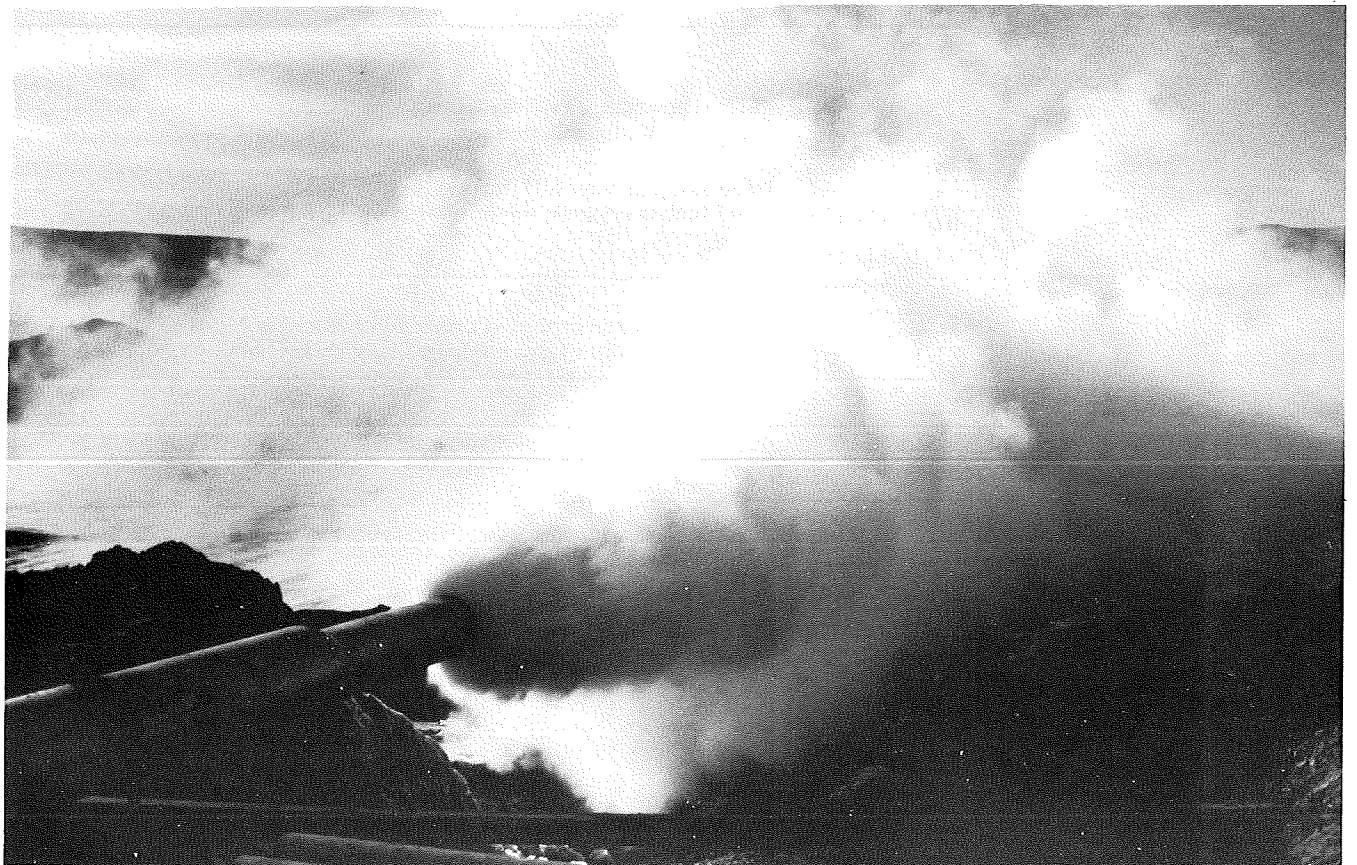

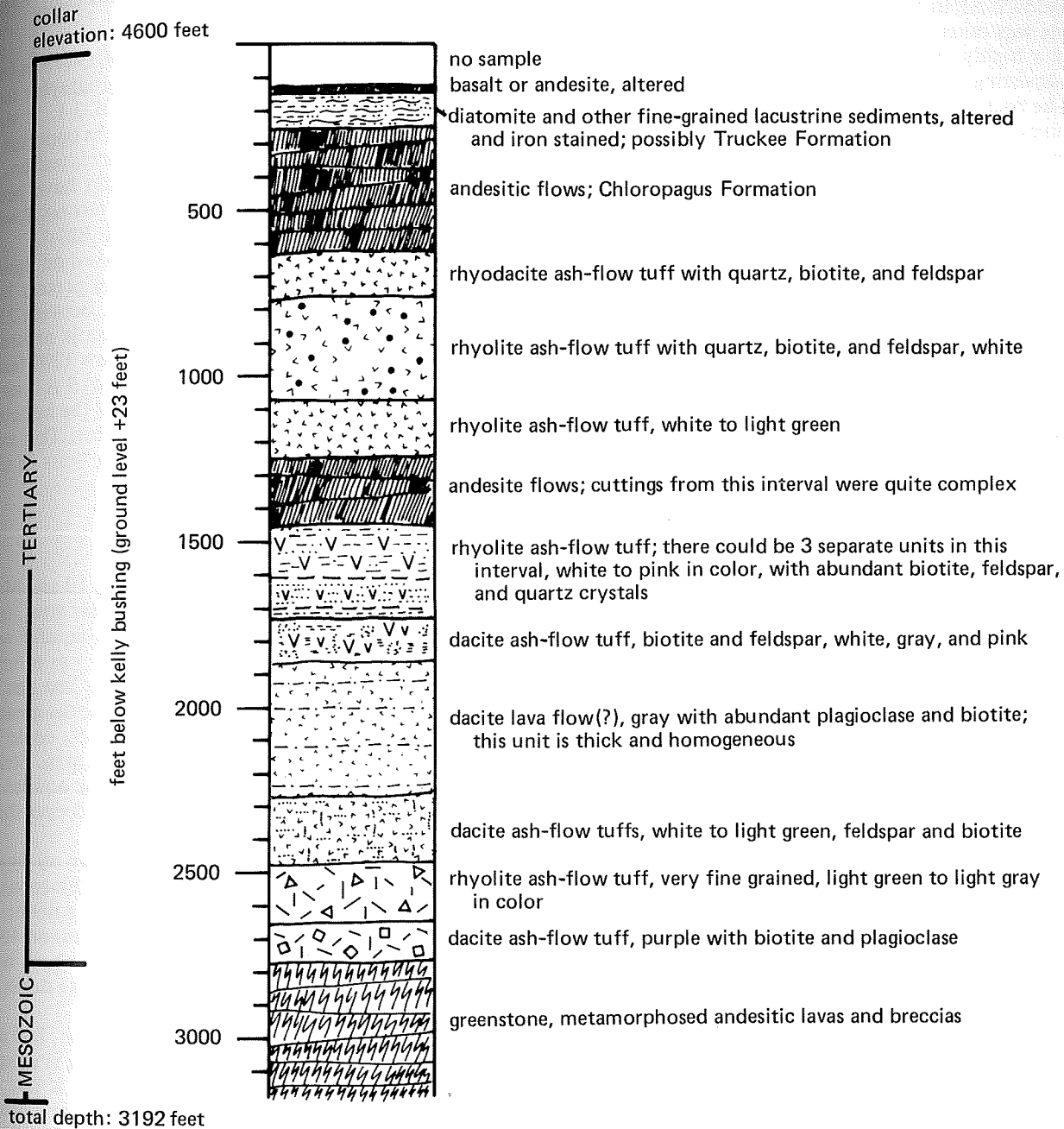

location: NE/4 NE/4 S21, T22N, R27E  
 Churchill County, Nevada  
 started: November 23, 1976  
 completed: December 20, 1976

FIGURE 19. Lithologic log of Desert Peak well B21-2.

not run below a depth of 2900 feet. A core consisting of greenstone was taken between depths of 2937 and 2949 feet; it is a highly fractured metamorphosed andesitic breccia consisting of angular fragments up to 3 inches in length. The rock has been fractured but not sheared, as the fractures have no slickensides or fault gouge. Quartz or calcite vein fillings are also absent. The entire pre-Tertiary section penetrated in well B21-2 is suspected to consist of greenstone.

The temperature profile of well B21-2 is the most complicated to date in the Desert Peak area (pl. 6). The top 2000 feet are very similar to the profile from strat. test no. 5, previously discussed. The temperature profile shown on plate 6 has the same problem as the strat. test no. 5 profile; the temperature of the isothermal section near the top of the hole is probably 12°F too low. A partial temperature log of well B21-2 by a second operator showed this isothermal section to have a temperature of 207°F. At a depth of 2540 feet the temperature gradient abruptly decreases to nearly 1°F/100 feet. On plate 6 a small temperature reversal is shown at 2900 feet. This reversal is the result of severe lost-circulation problems (see section of this report on the Desert Peak reservoir), and the lowest part of the temperature profile does not represent equilibrium conditions.

This nearly isothermal section represents the geothermal reservoir. It is interesting that this nearly isothermal section extends about 245 feet up into the rhyolitic unit and about 330 feet above the known top of the production zone. Reservoir fluids may be convecting a couple of hundred feet up into the Tertiary rhyolitic rocks, and it may be possible to intersect the productive zones nearby at slightly shallower depths.

After well B21-2 was completed another cross section similar to figure 15 was constructed (fig. 20). This cross section shows some deeper temperature data not available on figure 15. The 400°F isotherm on figure 20 is probably the best representation of the reservoir boundary presently available.

## DESERT PEAK STRATIGRAPHIC TESTS SIX THROUGH EIGHT (AND OTHERS)

### STRATIGRAPHIC TEST NO. 6

Strat. test no. 6 was drilled to a depth of 1934 feet between March 9 and 19, 1977. The hole was located to evaluate several sections of Federal land which would soon be offered at a lease sale.

A lithologic log of strat. test no. 6 is shown on figure 21. Quaternary and upper Tertiary sediments and sedimentary rocks are present to a depth of 730 feet. Below 730 feet mafic lava flows of the Chloropagus Formation are present. Within the Chloropagus Formation sedimentary sections of clay, sand, and gravel are common. This hole bottomed in the Chloropagus Formation and there is no way to estimate the depth to the rhyolitic section.

Strat. test no. 6 has a generally linear profile (pl. 6). The bottom-hole temperature is 199°F and the bottom-hole gradient is 8.0°F/100 feet.

### STRATIGRAPHIC TEST NO. 7

Strat. test no. 7 was drilled to a depth of 1944 feet between April 27 and May 6, 1977. This stratigraphic test is located about 200 feet north of well B23-1. It was drilled for two reasons. First, it provided the opportunity to evaluate the B23-1 well site. Had strat. test no. 7 been discouraging, then well B23-1 would have been either moved or cancelled. Second, strat. test no. 7 was used to prepare a casing program for well B23-1.

A lithologic log of strat. test no. 7 is shown on figure 22. Upper Tertiary sedimentary rocks are present between the surface and a depth of 210 feet. Between 210 and 1200 feet the Chloropagus Formation is present. The rhyolitic sequence is encountered below 1200 feet.

The temperature profile for strat. test no. 7 is linear. The bottom-hole temperature is 251°F and the bottom-hole temperature gradient is 11.5°F/100 feet. This was one of the most encouraging stratigraphic tests in the Desert Peak area.

### STRATIGRAPHIC TEST NO. 8

Strat. test no. 8 was drilled between May 10 and May 24, 1977, to a depth of 2000 feet. By the time strat. test no. 8 was drilled the near-surface thermal aquifer was relatively well understood; however, there was a large part of the thermal anomaly west of strat. test nos. 1 and 4 which had not been evaluated to depths greater than 500 feet. It was possible that the reservoir could be present beneath the thermal aquifer in this area. Strat. test no. 8 was the first hole to penetrate the aquifer in this area and give some information on the deeper thermal structure.

A lithologic log of strat. test no. 8 is shown on figure 23. This hole was drilled entirely in the Chloropagus Formation and contained a relatively high amount of sedimentary material. There were some minor lost-circulation problems during drilling. As the hole bottomed within the Chloropagus Formation, the depth to the rhyolitic unit is not known.

The equilibrium temperature profile of strat. test no. 8 is shown on plate 6. This stratigraphic test is unique among the temperature profiles shown, as it has an isothermal section 1000 feet thick. This isothermal section may reflect a thermal aquifer or series of aquifers 1000 feet thick or it may be the result of vertical water movement within the wellbore. Combinations are also possible. In either case, there is a thermal aquifer (or aquifers) with its top at a depth of 300 feet. The cap for this aquifer appears to be a thin limestone at a depth of 300 feet. Below the 1000-foot-thick isothermal section the temperature gradient is 3.5°F/100 feet and the bottom-hole temperature is 160°F. This is the least encouraging of Phillips' stratigraphic tests at Desert Peak. It is unlikely that a geothermal reservoir is present in the vicinity of strat. test no. 8.

### OTHER STRATIGRAPHIC TESTS

Supron Energy Corporation drilled three stratigraphic tests in the region during the summer of

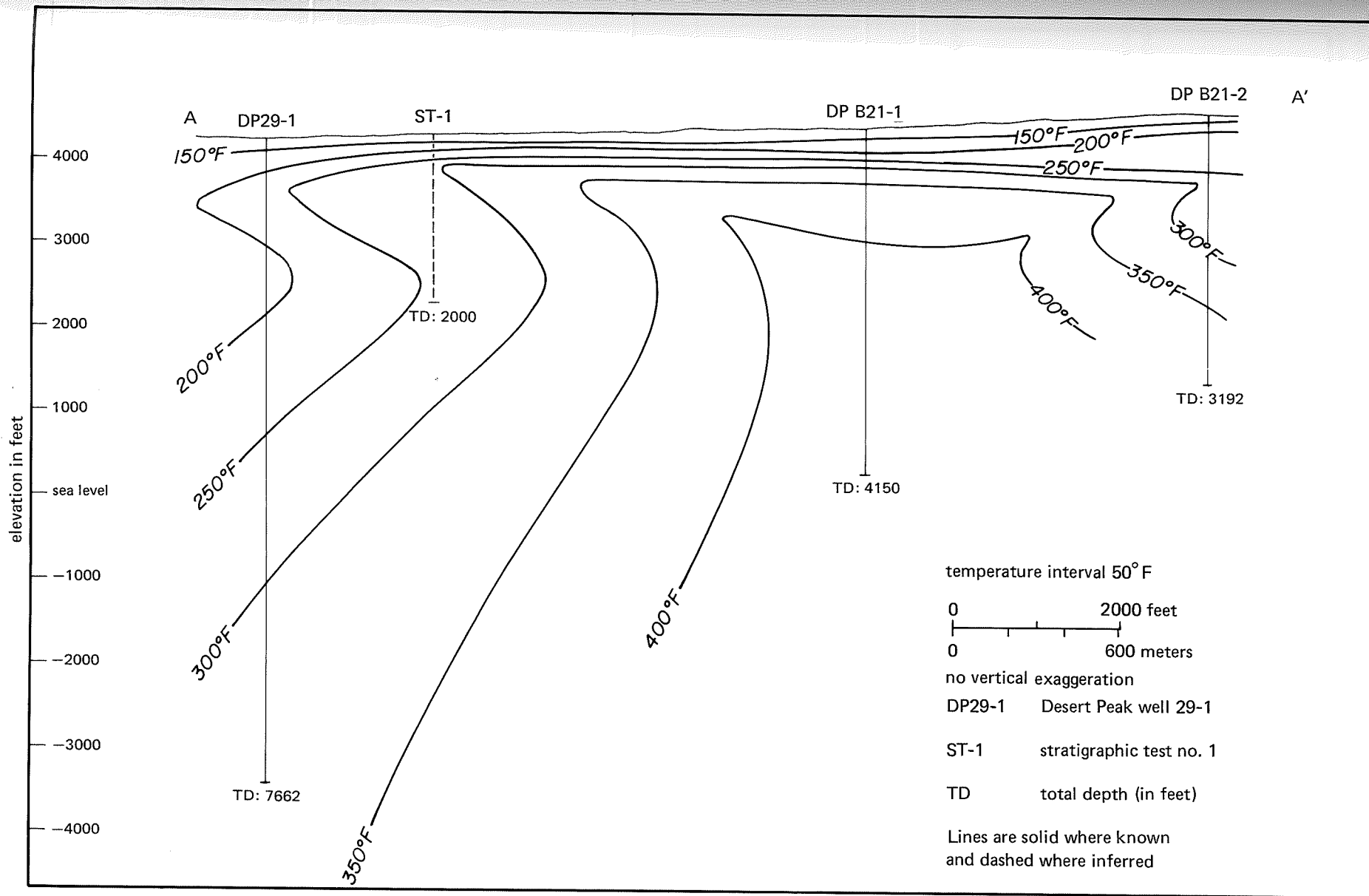

FIGURE 20. Temperature cross section A-A' based on deep wells (see plates 12 and 13 for location of A-A').

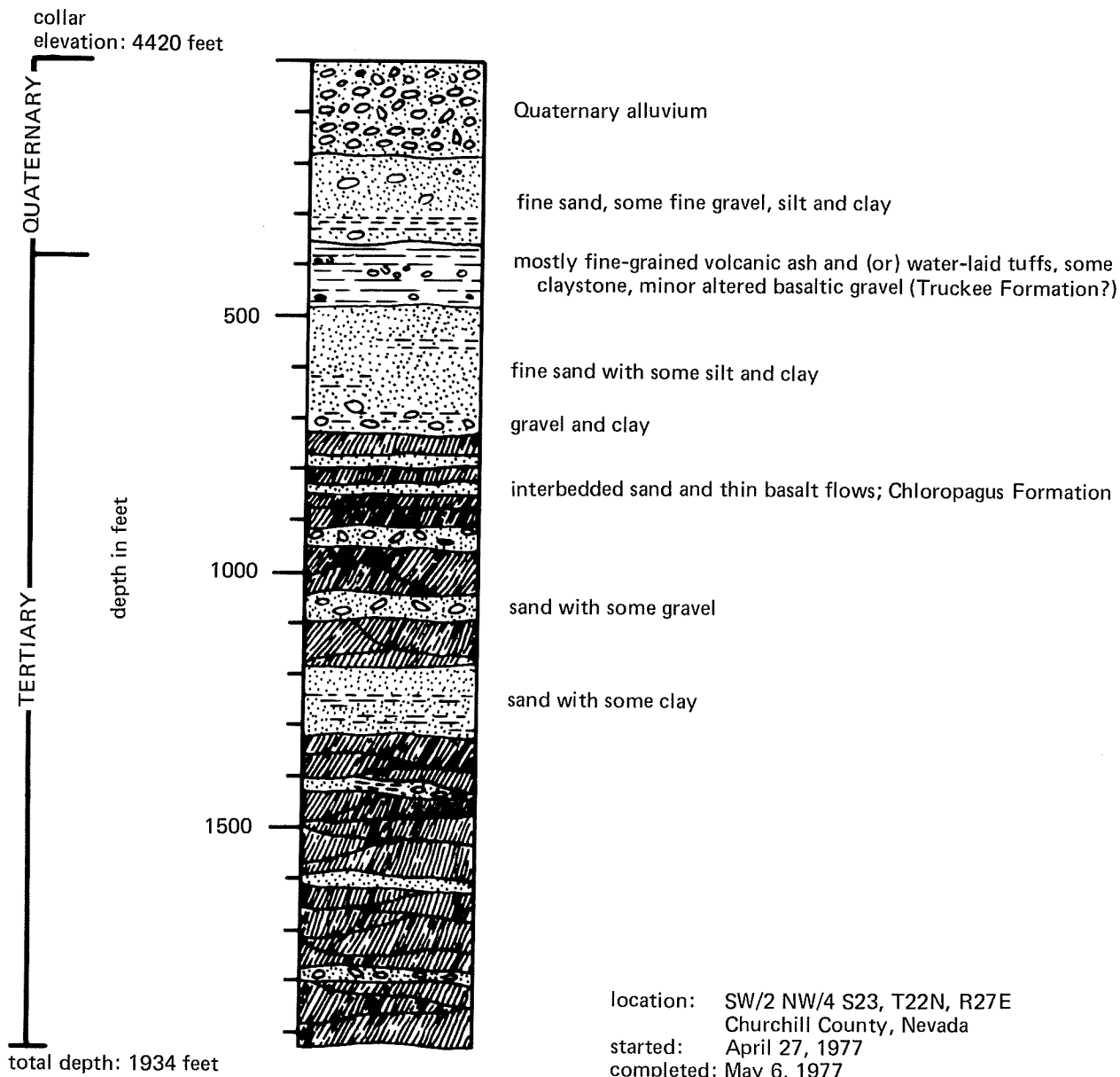

FIGURE 21. Lithologic log of Desert Peak stratigraphic test no. 6.

1977; during the summer of 1978 Thermal Power Company drilled four stratigraphic tests in the western part of the Desert Peak thermal anomaly. The depths and locations of these stratigraphic tests are shown on table 2.

### MAGNETOTELLURIC SURVEY

Magnetotelluric (MT) surveys are unique among electrical surveys since they can provide resistivity data from depths up to several tens of miles. Consequently, numerous magnetotelluric surveys have been run in geothermal exploration and research. The method is expensive and data handling and interpretation are complex. If additional information is desired on the magnetotelluric method the reader is referred to Pálmason (1975) for a brief description and to Vozoff (1972) for a more thorough treatment. No attempt is

made here to describe in detail the Desert Peak MT survey data acquisition, handling, or interpretation process.

During the fall of 1976 a high-quality, 32-station magnetotelluric survey was performed by the Research and Development branch of Phillips Petroleum Company. The results of this survey were not available in time to have any influence in the location of wells B21-1 or B21-2. A tentative location for well B23-1 had already been selected in the northwest corner of S23, T22N, R27E, but this site was moved about ¼ mile southward on the basis of the MT data.

The first results of this survey showed an obvious low resistivity area centered on S23, T22N, R27E at depths of 3000 to 5000 feet. This MT anomaly was encouraging, as it correlated well with what was known and expected in the area. This encouragement did not last long, as several months later an equipment malfunction was

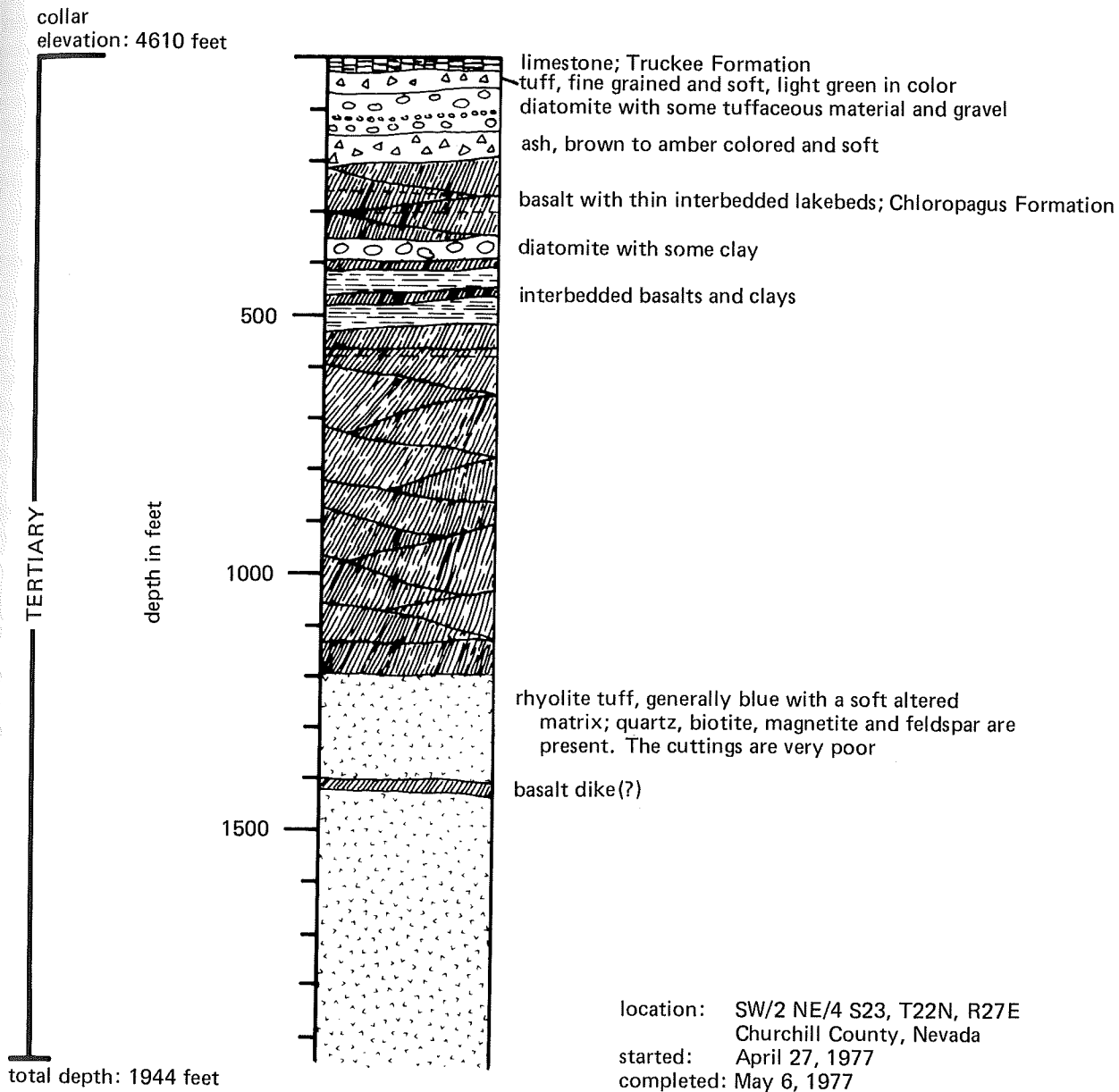

FIGURE 22. Lithologic log of Desert Peak stratigraphic test no. 7.

discovered which resulted in decreasing the depth of this anomaly to between 1000 and 3000 feet. The anomaly was now obviously too shallow to reflect a reservoir and still fit the known temperature distribution. As the drilling pad for well B23-1 had already been constructed and the temperature data from strat. test no. 7 were encouraging, the site was not moved.

Later analysis of the MT survey reconfirmed that the quality of the raw data is excellent; however, some of the mode selections appeared to be in error (Charles Swift, personal commun., 1978). As a result of this discovery the Desert Peak MT survey was thoroughly re-evaluated (John Maas, personal commun., 1979) and some of the refined data are presented in this report. Three slice maps which show the minimum apparent resistivity at depths of 1000, 4000, and 8000 feet are shown as plates 7, 8, and 9.

The apparent resistivity at a depth of 1000 feet (pl. 7) is, with the exception of one point, very low, and the contours show little character. In T22N,R28E there is a single-point resistivity high which may be the result of the site being located on a young, resistant ash-flow sheet (pl. 13). The very low nature of the apparent resistivities is unexpected, as much of the survey area is underlain by volcanic bedrock near the surface and the water table is generally more than 150 feet below the surface; occasionally it is 500 feet deep. Plate 8 shows the apparent resistivity at a depth of 4000 feet, which is an approximate known depth of the top of the reservoir. The contour pattern shows several small apparent resistivity highs and lows, most of which are single-point anomalies. The most interesting feature is the resistivity high containing wells B21-1 and B21-2. Generally, in geothermal exploration hot saline reser-

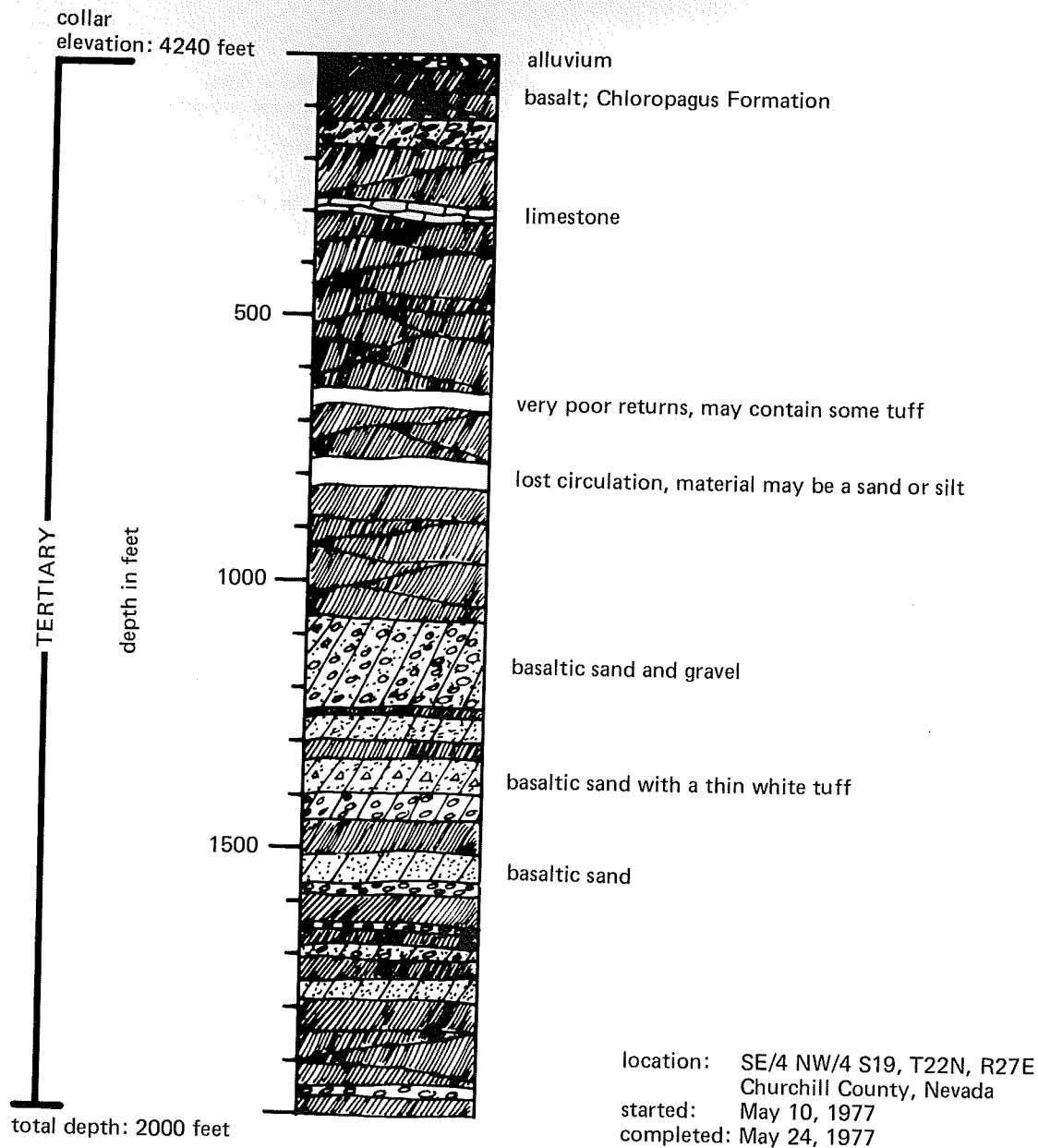

FIGURE 23. Lithologic log of Desert Peak stratigraphic test no. 8.

voirs should be characterized by low resistivity values (Meidav and Tonani, 1975). The electrical resistivity of many of the classical geothermal systems is less than 5 ohm meters; yet near wells B21-1 and B21-2 the apparent resistivity is never less than 8 ohm meters and it increases rapidly below a depth of 3000 feet, which is the top of the reservoir in well B21-2. Dry steam or gas reservoirs may be characterized by high resistivities, but the Desert Peak reservoir is full of highly conductive hot water. The bulk resistivity of this fractured reservoir could be on the order of 10 or 20 ohm meters, especially if the fracture permeability is in the 1% range (John Maas, personal commun., 1979). In this case the thermal fluids would not be easily detectable, due to a low resistivity contrast with the surrounding rocks.

The apparent resistivity slice map at a depth of 8000 feet (pl. 9) corresponds with the deepest available

geologic and thermal data. The contour pattern is the same as at a depth of 4000 feet (pl. 8) but the apparent resistivity highs and lows are more intense. A deep low is located  $\frac{1}{2}$  mile west of well 29-1. Without the results from well 29-1 this low might be interpreted as a possible reservoir. However, the well 29-1 results show that the low is not associated with a geothermal reservoir. This low does correlate well with the hottest part of the near-surface thermal anomaly (pl. 1). In the northeast corner of plates 8 and 9 the margin of a deep low is present. This low is probably a function of saline water and fine-grained sediments filling the main Carson Basin, since the available temperature information does not suggest a reservoir in this area.

To date, the MT survey at Desert Peak has been of little use. In all likelihood any deep holes located primarily from the MT data would have been unsuccessful. The



known part of the reservoir appears as part of a resistivity high (S21) and part of a resistivity low (S23). One of the interesting low resistivity areas has been proven not to be associated with a geothermal reservoir. The second low resistivity area is probably not related to a reservoir. At the present time the ultimate value of this survey is unknown.

**TABLE 2. Data on Supron Energy Corporation and Thermal Power Company stratigraphic tests in the Desert Peak area.**

Hole	Location	Depth
Supron 13-1	SW/4 S13,T23N,R26E	1717 ft
Supron 25-1	NE/4 S25,T22N,R26E	510 ft
Supron 36-1	SW/4 S36,T22N,R26E	1766 ft
Thermal 4-1	SE/4 S4,T22N,R27E	1995 ft
Thermal 24-1	SE/4 S24,T22N,R26E	2000 ft
Thermal 26-1	NW/4 S26,T22N,R26E	1500 ft
Thermal 30-1	NE/4 S30,T22N,R27E	2000 ft

### DESERT PEAK WELL B23-1

Immediately after well B21-2 was determined to be successful the pad for B23-1 was constructed (once again on private land) about 1¼ miles east of the two previous wells. No prior stratigraphic test data were available for this site and geology was not a factor in this location. The Desert Peak thermal anomaly is so large that these exploratory holes had to be widely spaced for proper evaluation.

Immediately before drilling began in January 1977 the rig was released and a more thorough evaluation of the results from wells B21-1 and B21-2 was undertaken. It was more than two years later when well B23-1 was spudded. However, during this two-year period much additional new data were obtained and interpreted. Ten stratigraphic tests were drilled by Phillips, Supron Energy Corporation, and Thermal Power Company; two reservoir tests were conducted; a detailed geologic map and gravity survey were completed; and attempts were made to further evaluate the MT survey. Much of these new data confirmed that the well B23-1 was a promising location for a large step-out.

Well B23-1 was spudded on March 19, 1979, and the rig was released on May 30, 1979. The well reached a total depth of 9641 feet. Well B23-1 intersected the geothermal reservoir but its production capability is not known. During a nine-day flow test in November 1979 the well produced approximately 100,000 to 140,000 pounds per hour of fluid. As is the case for all the Desert Peak geothermal wells, it was necessary to use nitrogen to displace a portion of the standing fluid and start the well flowing, but once it began flowing it continued without assistance (fig. 24). The low flow rate resulted in a low wellhead temperature of 228°F and a wellhead pressure of 8 psig. After the flow test a temperature survey was attempted, but a sinker bar could not be lowered below the casing shoe at 3000 feet. The extent of hole blockage is unknown; as a result, the true production capability of well B23-1 is unknown.

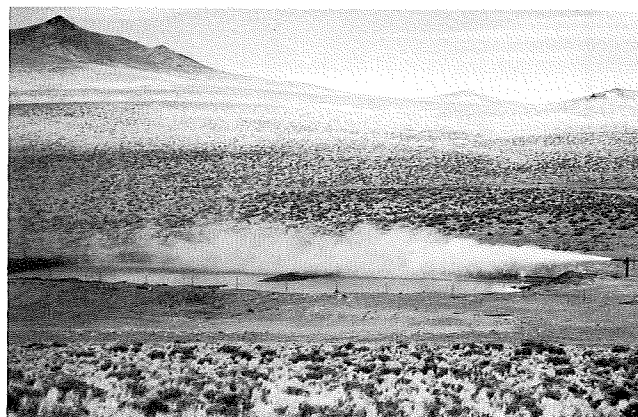

**FIGURE 24. Photographs of Desert Peak well B23-1 flowing. View looking north. Desert Peak is present at the far left.**



There are limited data available to conclusively locate the producing zones in the reservoir in well B23-1. The available evidence is discussed in the section of this report on the Desert Peak reservoir. A lithologic log of well B23-1 is shown on figure 25. The major units noted in the previous wells are all present in well B23-1. However, there are substantial lithologic differences within the major units when well B23-1 is compared with the previous wells. Well B23-1 is located about 200 feet south of strat. test no. 7, and as expected both holes reveal the same geology.

The top 40 feet of B23-1 consist of Quaternary sand, gravel, and boulders. From 40 to 225 feet limestone and tuffaceous sediments of the Truckee Formation are present. This sequence and the top of the underlying Chloropagus Formation are well exposed in the hills about ½ mile south and east of well B23-1.

Between 225 and 1325 feet basalt, basaltic andesite, and andesite flows and breccias of the Chloropagus Formation are present. Three lacustrine units are present between 380 and 400 feet, 495 and 570 feet, and 590 and 650 feet. These units are composed of white to green to brown, fine-grained, tuffaceous sediments which have been locally silicified. Pyrite was first observed at a depth of 340 to 350 feet. Below this depth pyrite (in varying quantities) is present throughout most of the hole.

From 1325 to 4225 feet the rhyolitic unit consists of a series of andesitic to rhyolitic ash-flow tuffs and lava flows. Seven major subunits have been noted on the lithologic log. The gamma log suggests that several of

collar  
elevation: 4595 feet

TERTIARY

MESOZOIC

feet below Kelly bushing (ground level +23 feet)

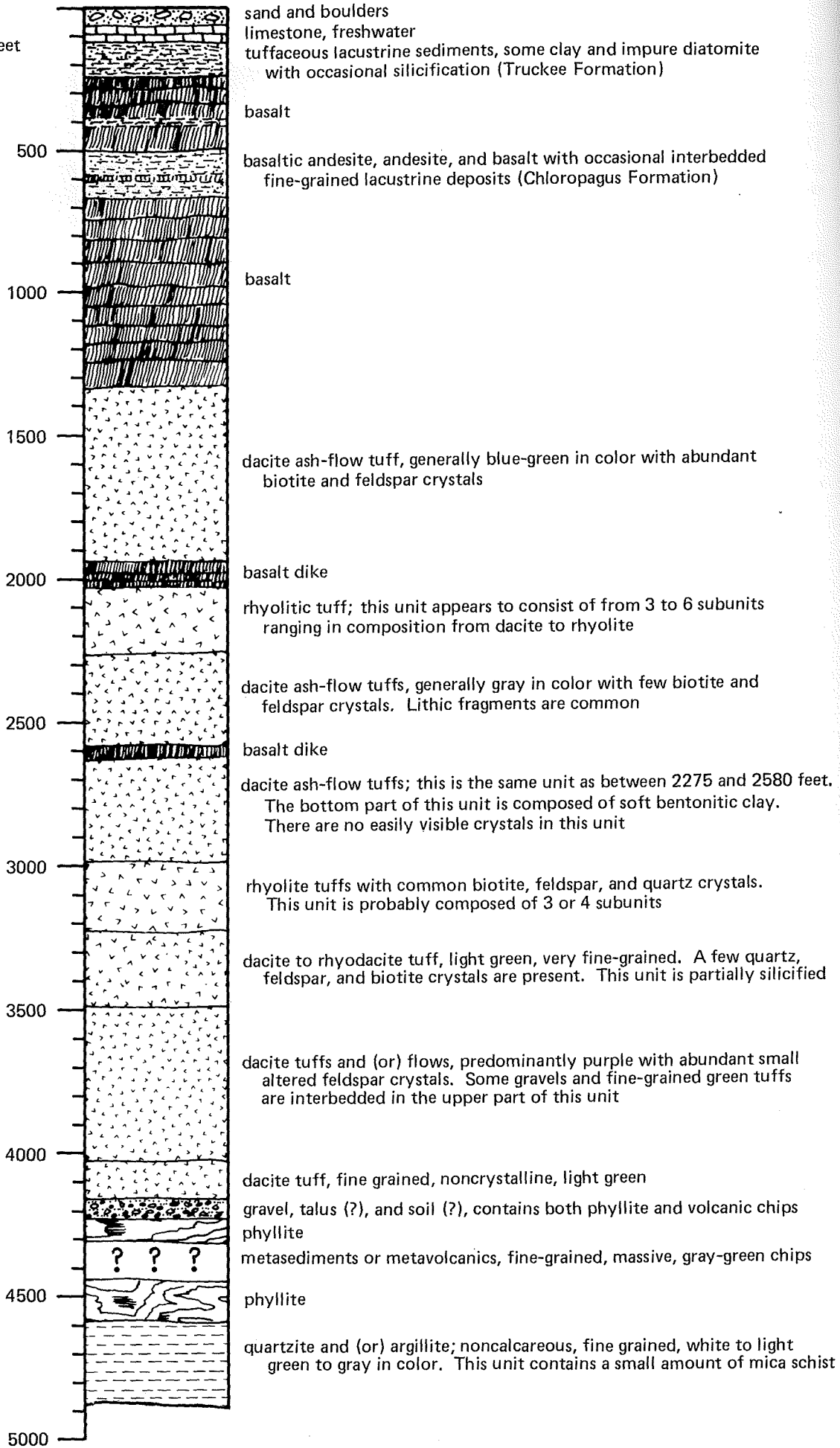

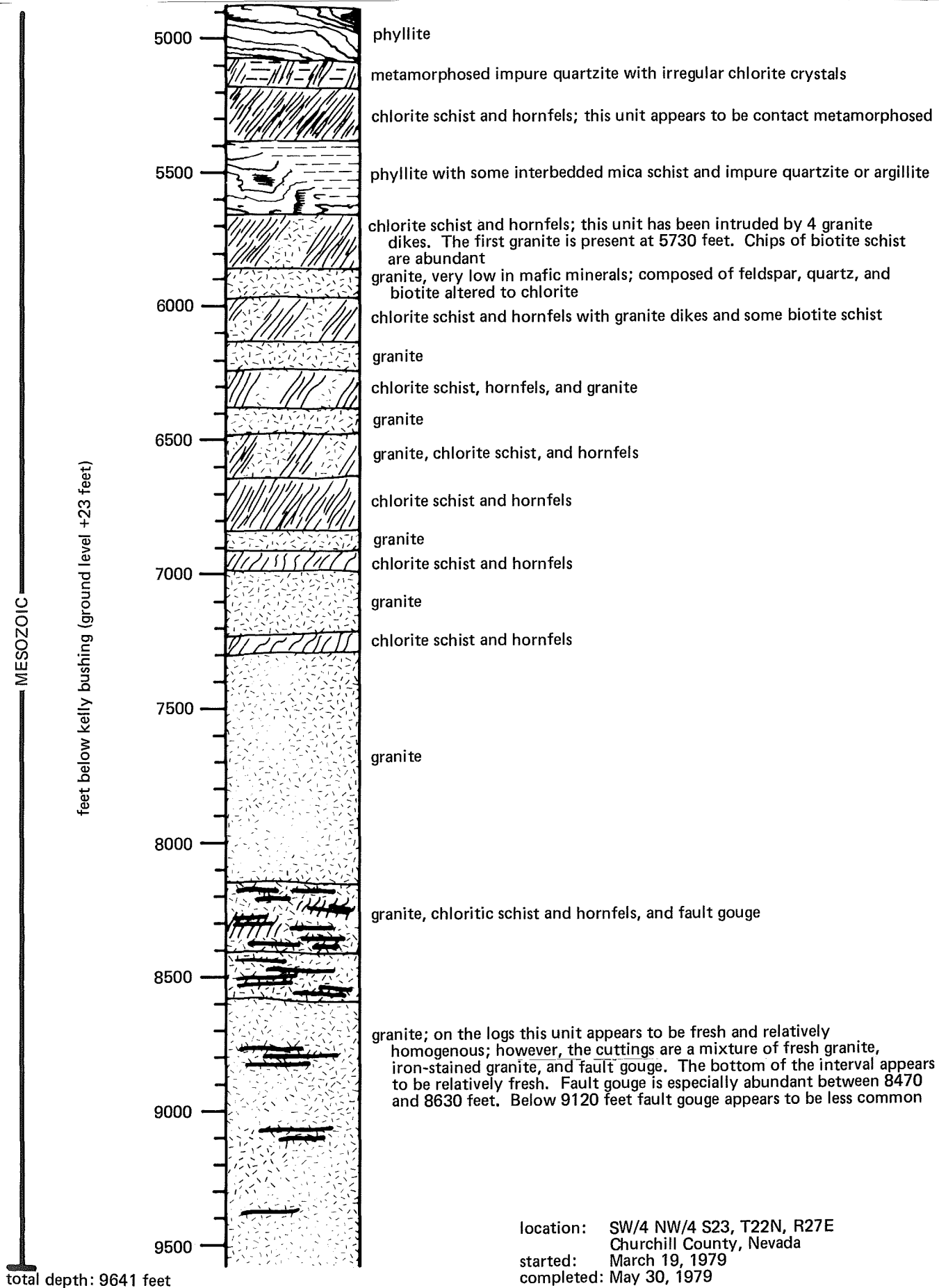

FIGURE 25. Lithologic log of Desert Peak well B23-1.

the subunits can be further divided. The entire unit is generally dacitic in composition with lesser amounts of rhyodacite, rhyolite, and andesite. Two thin basalt units are present. The Tertiary rhyolitic unit in well B23-1 is considerably different from that found in wells 29-1, B21-1, and B21-2. In well B23-1 there is very little rhyolite. Dacite is the most common lithology. Also, distinctive marker units found at or near the base of the rhyolitic section in wells 29-1, B21-1, and B21-2 are not present in well B23-1. The rhyolitic unit is 2900 feet thick in well B23-1, making it the thickest section yet encountered in the area.

Regionally metamorphosed pre-Tertiary sedimentary rocks are present from 4225 to 5640 feet. Phyllite is the dominant lithology. Interbedded with the phyllite are layers or lenses of impure quartzite, argillite, chlorite schist, and possibly minor amounts of metavolcanic rocks. The pelitic and generally homogeneous nature of this unit suggests that it could be part of the upper Triassic Auld Lang Syne group (Johnson, 1977; Burke and Silberling, 1973).

It is important to note that no thick sections of greenstone similar to those found in wells B21-1 and B21-2 are present in well B23-1. The Mesozoic section in well B23-1 is also substantially different from that in well 29-1, as the sequence is mostly pelitic. Well 29-1 has a much greater variety of rock types than does well B23-1.

From 5640 to 7300 feet the section consists of roughly equal amounts of granite and chlorite schist or hornfels. Near a depth of 6000 feet chips of biotite schist are common in the cuttings. The nature of the contact relations between the chloritic schist and hornfels and the granite over a range of about 1700 feet suggests that the hole may be located close to a steeply dipping margin of the granitic intrusive or that the contact is gradational with many dikes extending out from the pluton and many large xenoliths or roof pendants imbedded within the pluton. The chlorite schist and hornfels unit is interpreted as part of a contact metamorphic aureole associated with the margins of the granite and is part of the Mesozoic pelitic sequence. Similar rocks are present in the nearby Truckee and Trinity Ranges (Willden and Speed, 1974).

Below a depth of 7300 feet, granite is the dominant lithology. Between 7270 and 8170 feet the granite is moderately altered. The biotite has been partially altered to chlorite in all of the samples, and much of the feldspar has been altered to clay. The granite is rich in quartz and poor in mafic minerals. No hornblende is present.

Between a depth of 8170 and 9641 feet the rocks consist of a mixture of moderately altered granite, fault gouge, minor chloritic schist, and some iron-stained granite. In this interval lost-circulation problems were chronic. Up to 2500 barrels of drilling fluid were lost every day. However, circulation was never completely lost as in wells B21-1 and B21-2. Many samples have a significant amount of brown to orange iron staining; however, most of these samples also contain abundant metal shavings from the casing, bit, or drill string, and some of the iron stain may be a result of the metal shavings. The fault gouge is a highly sheared, soft, waxy-looking clay ranging in color from blue-green to brown.

Below a depth of 9120 feet the fault gouge in the cuttings decreases.

The gamma log from well B23-1 shows that the gamma ray activity of the granite is not homogenous. (Benoit and others, 1980). In the interval between 5730 and 6740 feet, where most of the intercalation of granite and chlorite schist and hornfels occurs, the granite has a radioactivity greater than 200 API units. Below 6740 feet, where the granite is more massive, the radioactivity drops sharply to an average of 130 API units. To determine the reasons for this difference would require additional chemical and (or) petrologic studies.

Although no granite or granodiorite is exposed in the Hot Springs Mountains, Cretaceous granites are common in the nearby mountain ranges (fig. 2). The granite in well B23-1 is also expected to be Cretaceous but a Tertiary age cannot be excluded with the available data.

An equilibrium temperature profile of well B23-1 is shown on plate 6. This single profile, however, does not present a clear picture of the thermal structure in the well. The additional nonequilibrium temperature profiles shown on figure 26 aid greatly in understanding this well.

To a depth of 3200 feet the equilibrium temperature profile is nearly linear and has an average gradient of 9.3°F/100 feet (pl. 6). Between 3200 and 5200 feet the gradient smoothly decreases to zero at a temperature of 409°F. Between 5200 feet and 8900 feet the temperature is nearly isothermal, varying only about 6°F. Below 8900 feet the temperature gradient is consistently positive at 0.8°F/100 feet. The bottom-hole temperature of 413°F makes this the hottest hole drilled to date at Desert Peak. Previously unpublished temperature surveys were also run in well B23-1 by the USGS (T. C. Urban, personal commun., 1979) (fig. 26). These surveys showed temperatures from 9 to 15°F colder below 3200 feet than the wireline surveys obtained by Phillips. The wireline data are used in this report to maintain data consistency between all the deeper holes and wells. No USGS data were obtained below 7000 feet.

There is some correlation between changes in the temperature gradient and major changes in lithology. The temperature profile becomes isothermal at a depth of 5200 feet. At a depth of 5180 feet the Mesozoic rocks change from predominantly phyllite to schist. The schist may be slightly more competent than the phyllite and able to maintain fractures allowing reservoir fluids to circulate freely. Fractures in the softer phyllite probably heal too quickly to allow significant convection.

At 8900 feet the temperature gradient changes from isothermal to 0.75°F/100 feet. At about 8400 feet the granite has abundant fault gouge, and chronic lost-circulation problems developed with losses as great as 2500 barrels per day throughout the drilling of the rest of the hole. There may or may not be a relationship between the two features but it is interesting to speculate whether or not this fault zone at 8400 feet represents the bottom of the reservoir. The positive gradient segment at the bottom of the hole could indicate a deeper and hotter source of heat in the area.

Two nonequilibrium temperature profiles were run 8½ and 37½ hours after drilling circulation ceased (fig.

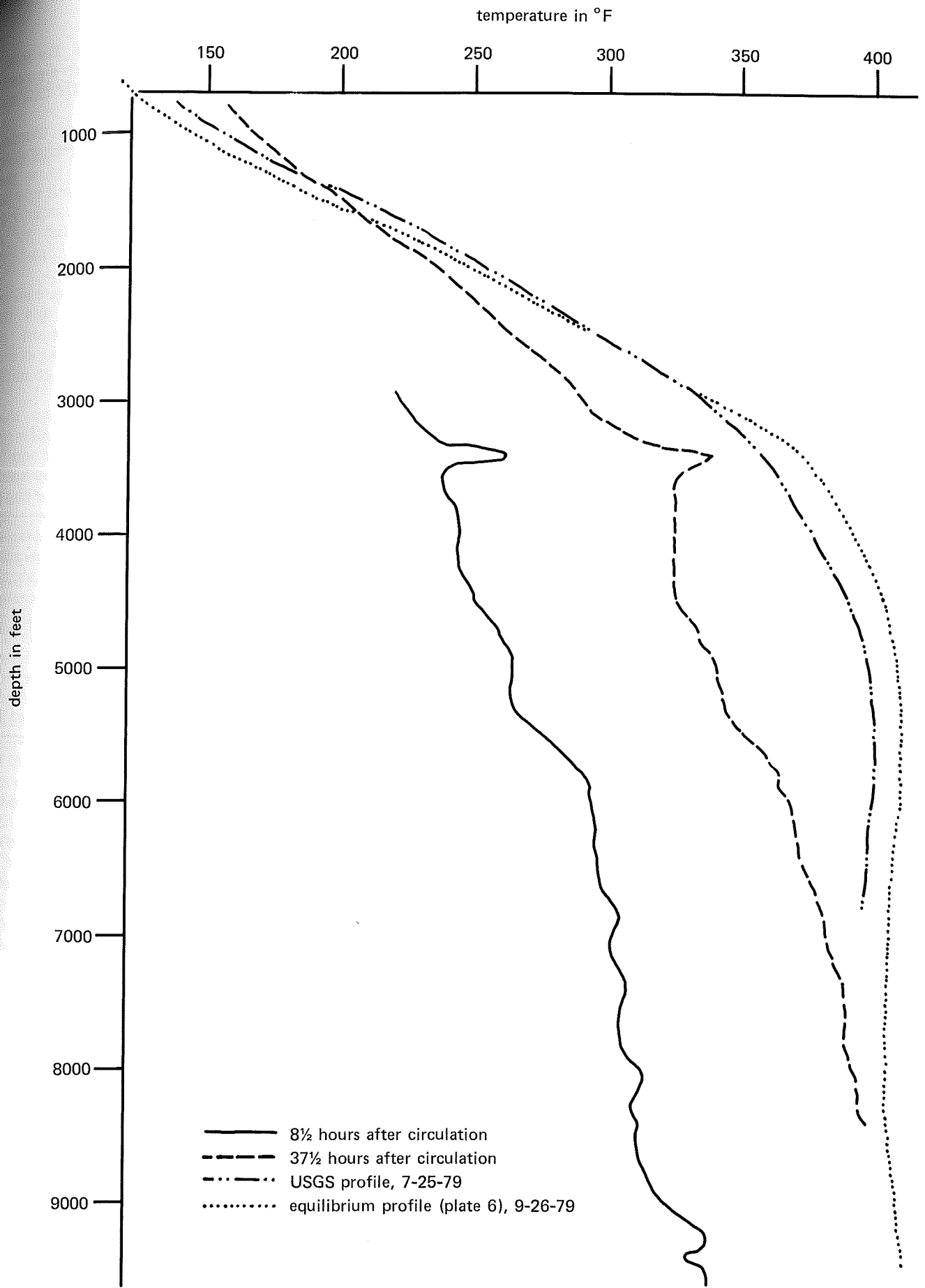

FIGURE 26. Temperature profiles of Desert Peak well B23-1.

26). The most significant feature on these profiles is the sharp temperature reversal which occurs at a depth of 3400 feet. This reversal must have formed quickly after circulation ceased, because it is well developed after only 8½ hours. Mass transfer of heat via moving thermal water is required for this reversal to form so quickly. Evidence from the profile taken 37½ hours after circulation and the equilibrium profile indicate that once the reversal has formed, this interval appears to heat by conduction at about the same rate as the rest of the hole. The equilibrium temperature of this aquifer is 372°F, yet 37½ hours after circulation ceased the maximum temperature of the reversal was 340°F.

This aquifer, at 3400 feet, plays an important role in determining the shape of the equilibrium temperature profile in well B23-1. As previously noted, the temperature profile begins to decrease from 9.3°F/100 feet to 0°F/100 feet at a depth of 3200 feet. Therefore, nearly all of the interval between the aquifer and the surface is at a steady-state thermal equilibrium. This indicates that the aquifer has been active for a considerable period of time.

Between 3150 and 5200 feet the temperature gradient smoothly decreases, giving a convex upward profile. This part of the temperature profile represents a late stage in the approach to thermal equilibrium in the rocks between the aquifer at 3400 feet and the top of the isothermal section of the reservoir at 5200 feet. Urban and others (1978) have described a similar case in the East Mesa geothermal anomaly.

## NEAR-SURFACE THERMAL AQUIFERS

The existence of at least four near-surface thermal aquifers has been proven by drilling at Desert Peak and Brady's. The locations of the aquifers and the distribution of temperature within the aquifers are shown on plate 10.

The thermal anomaly is largely a result of heat flowing upward from the near-surface thermal aquifers. Therefore, the boundaries shown on plate 10 were chosen to coincide closely with the temperature-gradient map (pl. 1). This is particularly true along parts of the southwest boundary of the thermal anomaly where the temperature gradients decrease very rapidly in a short horizontal distance. The thermal aquifers have been defined by temperature data rather than by hydrologic data. As the drill holes are usually over 1 mile apart and are clustered over the centers of the aquifers, the thermal boundaries shown are approximate. These boundaries are conservative and the aquifers may be more extensive than shown. The elevation and saturated thickness of the aquifers have been defined by the elevation and length of the temperature reversals or isothermal sections in temperature profiles.

Lithologic and temperature data from the drill holes show that the aquifers are complex in detail. The boundaries of the aquifers often do not correspond with recognized geologic or topographic features. Flow direction and velocity, saturated thickness, and temperature distribution are controlled by incompletely

understood structural and lithologic factors. For these reasons and because of a paucity of data, only a general discussion of the aquifers is possible. Aquifer data are shown on table 3.

The most extensive of the near-surface thermal aquifers is located south and west of the producing wells at Desert Peak. This aquifer is referred to as the Southwest Aquifer (informal name), although it may be a series of smaller aquifers. On plate 10 the aquifer is shown to consist of two lobes separated by a topographical divide which trends northeasterly through S33,37,T22N,R27E.

The aquifer underlies approximately 14 square miles. The temperature cross section (fig. 20) and the geochemical data (see section of this report on geochemistry) show that water in this aquifer comes from the Desert Peak geothermal reservoir at an initial temperature of about 400°F.

Measured temperature gradients are greater than 20°F/100 feet above most of the Southwest Aquifer (pl. 1). The maximum measured temperature of the aquifer is 299°F in strat. test no. 1, although it must be hotter near its source, the geothermal reservoir. The cooling of the Southwest Aquifer as it moves away from the reservoir is shown on plate 10. The temperatures shown on plate 10 are the maximum temperatures at temperature reversals or the maximum temperatures in isothermal sections on the temperature profiles. Some temperature gradient holes have extremely high gradients but do not show isothermal sections or temperature reversals. The high gradient is assumed to be a response to the thermal aquifer below the drill hole, and the maximum temperature in the hole is used to set a minimum temperature constraint for the aquifer. The control for aquifer temperature is good in the northwestern lobe of the Southwest Aquifer and almost nonexistent in the southeastern lobe.

Plate 11 is a contour map drawn to depict the tops of the aquifers as defined by temperature data. The aquifers probably are confined or semiconfined, based on the few water level measurements available. In all cases water levels are above the aquifers. Plates 10 and 11 show that water in the northwest lobe of the Southwest Aquifer is flowing westerly and southwesterly from a northwest-trending line running through S19,20,21,28,29. Temperature data from the stratigraphic tests and deep tests also show a northwest-trending lineament in this area (pl. 12) that appears to define the southwest boundary of the reservoir. Gravity data (see section of this report on gravity) suggest this line is a substantial fault. There are no data for the aquifer elevation in the southeast lobe.

A possible model of this aquifer has thermal water leaking out of the reservoir via a steeply dipping reservoir boundary fault. As the water rises, it spreads laterally along the fault. At a certain stratigraphic and (or) structural level it then spills out along the length of the fault as an extensive sheet and flows down gradient utilizing whatever permeability is available. On plate 11 the closely spaced contours between hole no. 11 and well 29-1 illustrate the possible complexities of this aquifer. The holes are about 0.3 miles apart, yet the difference in the elevation of the temperature reversal may be as

TABLE 3. Desert Peak thermal aquifers.

Designation	Elevation	Depth to top of aquifer	Elevation on top of aquifer	Thickness of aquifer	Average temperature gradient over aquifer	Maximum temperature of aquifer	Maximum temperature decrease below aquifer	Depth below aquifer at which temperature gradient becomes positive
<i>Southwest Aquifer</i>								
ST-1	4275 ft	360 ft	3915 ft	10 ft or less	64°F/100 ft	299°F	42°F	1360 ft
DP 29-1	4240 ft	700 ft	3540 ft	10 ft or less	25°F/100 ft	243°F	52°F	900 ft
30-1	4120 ft	300 ft	3820 ft	200 ft	45°F/100 ft	200°F	38°F	840 ft
25-1	4090 ft	70 ft	4020 ft	>330(?) ft	extremely high	179°F	---	---
ST-8	4240 ft	300 ft	3940 ft	up to 1000 ft	26°F/100 ft	139°F	0°F	up to 1000 ft
24-1	4178 ft	400 ft	3778 ft	450 ft	17°F/100 ft	128°F	0°F	~450 ft
28	4260 ft	>220 ft	<4040 ft	---	---	182°F	---	---
17	4340 ft	>200 ft	<4140 ft	---	---	191°F	---	---
30	4180 ft	>300 ft	<3880 ft	---	---	250 or 243°F	---	---
31	4310 ft	>270 ft	<4040 ft	---	---	158°F	---	---
13	4340 ft	>280 ft	<4060 ft	---	---	207°F	---	---
33	4380 ft	420(?) ft	3960(?) ft	---	---	93°F(?)	---	---
11	4240 ft	380(?) ft	3860(?) ft	---	---	237°F(?)	---	---
18	4440 ft	439 ft	<4001 ft	---	---	140°F	---	---
<i>Northeast Aquifer</i>								
22	4064 ft	250 ft	<3814 ft	---	23°F/100 ft	132°F	---	---
42	4120 ft	240 ft	3880 ft	10 ft or less	46°F/100 ft	178°F	11°F	---
44	3955 ft	180 ft	3775 ft	---	17°F/100 ft	103°F	0°F	---
52	4010 ft	220 ft	3790 ft	---	very high	193°F	13°F	---
<i>Well B21-2 Aquifer</i>								
B21-2	---	860 ft	---	10 ft or less	---	298°F	26°F	---
<i>Brady's Aquifer</i>								
1	4070 ft	400 ft	3670 ft	---	11.1°F/100 ft	101.7°F	---	---

much as 320 feet. The temperature data from the bottom of hole no. 11 leave some doubt as to the elevation of the reversal; however, the possible error is small compared to 320 feet. This variation could be the result of several factors but a lack of data precludes any reliable conclusions.

Hole 25-1 is an anomalous point on plates 10 and 11. The temperature of the aquifer is anomalously high and the elevation of the top of the aquifer, as defined by an isothermal section, is more than 250 feet higher than expected. This suggests a large vertical component to thermal groundwater flow in the area. Geologic mapping by Bonham (1961) and plates 3 and 13 suggest that hole no. 25-1 could be located near an unrecognized southerly extension of Brady's Fault. Thermal water is believed to be discharged upward from depth, along a steeply dipping fault, into the Southwest Aquifer in the vicinity of hole no. 25-1. Shallow temperature-gradient hole no. 8, located 0.4 miles east of hole no. 25-1, also provides evidence for a distinct thermal anomaly in this area. Hole no. 8 has a linear temperature gradient of 9.4°F/100 feet to a depth of 500 feet or an elevation of 3600 feet where a relatively low bottom-hole temperature of 114°F was measured. The absence of any irregularities in this temperature profile indicates that the aquifer is not present. In hole no. 8 any aquifer must be at an elevation less than 3600 feet. This means the aquifer, if present at greater depths, would have to dip southwestward precipitously from hole no. 30-1. Therefore, the 9.4°F/100 feet gradient in hole no. 8

probably reflects a deeper thermal origin than simply heat above the Southwest Aquifer.

One water sample (no. 22/26-25c) has been collected in the southwest quarter of S25, about ½ mile south of hole no. 25-1. The sodium, boron, potassium, and chloride contents are intermediate between water from the Desert Peak reservoir and water from the Brady's thermal system (see section of this report on geochemistry), suggesting that sample no. 22/26-25c is a mixed water. However, in other respects such as calcium and sulfate contents and the sulfate to chloride ratio, the water is similar to the Desert Peak reservoir water.

Saturated thickness of the aquifer, as defined by the length of the temperature reversal or isothermal section in a temperature log, increases from less than 10 feet in strat. test no. 1 and well 29-1 to possibly as much as 1000 feet in strat. test no. 8 (table 3 and pl. 6). West of S29 the saturated thickness is always at least 200 feet. As the saturated thickness increases the temperature reversal below the aquifer decreases.

An estimate of the volume of water flowing through the Southwest Aquifer can be made by assuming and utilizing several parameters. The aquifer is assumed to cover 14 square miles, and water in the aquifer is assumed to cool from 400 to 70°F within this area. The average temperature gradient is assumed to be 25°F/100 feet above the aquifer and all the heat flow is assumed to come from the aquifer. The thermal conductivity of the overlying rock is assumed to be 2.2  $\mu\text{cal/cm/sec}^\circ\text{C}$ . Using these figures, the calculated flow rate is about

315 gallons per minute. It is important to note that this calculation does not include the downward movement of heat below the aquifer, which over much of the area must be substantial. With the available data a flow rate of 500 gallons per minute seems to be a reasonable estimate.

If this aquifer were to discharge at the surface near the reservoir it would produce one of the most spectacular hot-spring areas in the United States. To date all data gathered on the aquifer have been concerned with its source and little attention has been paid to the discharge area. It appears that the majority of the discharge of the northwestern lobe of the aquifer occurs in the Eagle Marsh where it evaporates from the muddy playa. Springs in this discharge area produce only a few gallons per minute. No surface discharge points for the southeastern lobe of the Southwest Aquifer have been found. It appears to discharge as subsurface flow into the Carson Sink.

The second largest aquifer, which will be referred to as the Northeast Aquifer (informal name), forms the northeast lobe of the thermal anomaly (pl. 1). This aquifer covers about 11 square miles. The sparse temperature and elevation data (table 3 and pls. 10 and 11) suggest that the groundwater flow direction is north to northeast. To date, no stratigraphic tests or deep tests have been drilled into this aquifer and nothing can be said about its thickness or the deeper thermal structure. No geochemical data are available from the Northeast Aquifer. However, its proximity to the Desert Peak geothermal reservoir and its direction of flow indicates that the source of the thermal water is the Desert Peak geothermal reservoir. Water in this aquifer is assumed to flow in the subsurface into the Carson Sink as no springs are present near its cool margins.

The third aquifer associated with the Desert Peak geothermal system is found in well B21-2. This aquifer is in the rhyolitic unit at a depth of 860 feet. No stratigraphic control over the location of this aquifer has been documented. Because it is deeper than the Southwest and Northeast Aquifers it is not reflected by extremely high near-surface temperature gradients. Therefore, it cannot be outlined utilizing present data. Its direction of flow remains unknown.

The fourth near-surface thermal aquifer is associated with Brady's thermal system. It was first noted by Olmsted and others (1975). This aquifer underlies about 2 square miles of Hot Springs Flat immediately west of Brady's Fault. Olmsted has shown that the water rises in Brady's Fault and then flows westward through recent alluvial and lacustrine deposits. This aquifer has been intersected by Phillips' shallow temperature-gradient hole no. 1 and by USGS hole AH-2 (pl. 2). The deepest of these thermal aquifers is found in well B23-1 at a depth of 3400 feet; the aquifer is discussed in the section of this report on well B23-1.

These hot, moderately saline, near-surface aquifers should be located easily by the roving dipole resistivity survey; however, a comparison of the apparent resistivity and conductance maps (pls. 4 and 5) with the map showing the thermal boundaries of the aquifers (pl. 10) shows that these boundaries are not accurately outlined. In retrospect, the roving dipole survey appears to have

located the hottest part of the Southwest Aquifer. The Northeast Aquifer was partially located by the apparent resistivity map (pl. 4) but not by the apparent conductance map (pl. 5).

The near-surface thermal aquifers at Desert Peak are by no means unique. Deeper drilling at the Steamboat Springs, Soda Lake, Humboldt House, and San Emidio prospects has shown that similar aquifers are common in thermal areas in Nevada. When they are located at depths between 100 and 1500 feet they often create a large thermal halo which may make the detection of blind geothermal reservoirs more likely. At greater depths it is more difficult to recognize these aquifers without the use of deep and expensive drill holes. Once a shallow thermal aquifer has been discovered, it can be a relatively simple matter to trace it to its source—hopefully a viable geothermal reservoir.

### **ESTIMATED DEPTH TO 400°F AND PRODUCING ZONES IN THE RESERVOIR**

As of January 1980 fourteen stratigraphic tests have been drilled in the Desert Peak area. Three of these stratigraphic tests are paired with nearby deep wells: strat. test no. 2 and well B21-1, strat. test no. 5 and well B21-2, and strat. test no. 7 and well B23-1. In all three instances the stratigraphic tests were successful in that the paired deep tests intersected the geothermal reservoir; the bottom-hole temperature data from all three stratigraphic tests were used to estimate the depth to 400°F, which is approximately the average reservoir temperature. To accomplish this the temperature profiles were extrapolated, without any corrections, to greater depths.

It can be predicted from the temperature profile of strat. test no. 2 that 400°F should be reached at a depth of approximately 1500 feet (table 4). Well B21-1 encountered 400°F at a depth of 1730 feet, which is only 230 feet deeper than predicted. However, a productive zone within the reservoir was not intersected until a depth of 3638 feet. Clearly the temperature data alone from strat. test no. 2 did not accurately predict the depth to the top of the producing zone in the reservoir. The prediction is much more accurate when the temperature data and lithologic information are combined. Since the reservoir is now known to occur in pre-Tertiary rocks and the thickness of the Tertiary rhyolitic unit is roughly known, minimum estimated depths to the pre-Tertiary rocks based on lithology can be made, provided the depth to the top of the rhyolitic unit is known. The known thickness variation of the rhyolitic unit is from 1650 to 2800 feet. Strat. test no. 2 entered the rhyolitic unit at 1225 feet, which means the pre-Tertiary rocks should not have been expected above a depth of 2875 feet. Four deep holes have penetrated the rhyolitic unit, which thickens toward the northeast. This information can now be used to make more accurate predictions of the depth to the pre-Tertiary rocks. Data from well B23-1, however, have shown that simply knowing the depth to the pre-Tertiary rocks does not mean that the depth of the top of the reservoir is known. Where phyllite is present, its thickness should



TABLE 4. Data on Desert Peak stratigraphic tests.

Name	Location	Collar elevation	Total depth (drilled)	500 ft	1000 ft	1500 ft	2000 ft	Total depth	Total depth (temperature log)	Bottom-hole temperature gradient	Estimated depth to 400°F
Strat. test no. 1	SE/4 NE/4 S29, T22N, R27E	4275 ft	2000 ft	288	274	258	260	259 ft*	1975 ft	unprojectable	8000-9000 ft**
Strat. test no. 2	SE/4 SE/4 S21, T22N, R27E	4400 ft	1293 ft	264	337	398*	---	369 ft	1284 ft	~16.0°F/100 ft	~1500 ft
Strat. test no. 3	SW/4 NW/4 S7, T22N, R28E	4240 ft	1395 ft	156	195	220*	---	214 ft	1387 ft	4.8°F/100 ft	5300 ft
Strat. test no. 4	NE/4 SE/4 S17, T22N, R27E	4600 ft	1675 ft	123	162	193	222*	202 ft	1669 ft	5.9°F/100 ft	5000 ft
Strat. test no. 5	NE/4 NE/4 S21, T22N, R27E	4600 ft	2000 ft	199	279	302	340	339 ft	1993 ft	9.0°F/100 ft	2700 ft
Strat. test no. 6	NE/4 SE/4 S27, T22N, R27E	4420 ft	1934 ft	109	139	166	204	199 ft	1918 ft	8.0°F/100 ft	4400 ft
Strat. test no. 7	SW/4 NW/4 S23, T22N, R27E	4610 ft	1944 ft	98	140	197	253	251 ft	1938 ft	11.5°F/100 ft	3200 ft
Strat. test no. 8	SE/4 NW/4 S19, T22N, R27E	4240 ft	2000 ft	138	138	145	160	160 ft	1998 ft	3.5°F/100 ft	8900 ft

\*Projected farther than 100 ft.

\*\*Projection based on well 29-1 temperature profile.

be added to the thickness of the rhyolitic unit, as the phyllite appears to be incapable of maintaining fractures and behaves as a caprock. At the present time the distribution and thickness of phyllite in the Desert Peak area is unknown. Therefore, any lithologic estimates of the depth to 400°F or the depth to the producing zones within the reservoir, particularly near well B23-1, should be regarded as minimum depths.

The error in the temperature extrapolation of strat. test no. 2 is due to the nearby leak from the reservoir upward to within several hundred feet of the surface and then laterally outward into the Southwest Aquifer (see section of this report on near-surface thermal aquifers). Water movement up this fault locally has raised the 400°F isotherm far above the producing zones in the reservoir.

The temperature profile from strat. test no. 5 indicated that 400°F should be reached at a depth of approximately 2700 feet (table 4). Well B21-2 encountered near-isothermal reservoir temperatures of 386°F at 2540 feet (pl. 6). The reservoir at well B21-2 has a maximum measured temperature of 392°F. Therefore, a more accurate prediction would be the depth to 392°F; however, the difference between 392 and 400°F is small enough to be presently discounted. Reservoir temperatures in well B21-2 are encountered 160 feet above the predicted depth. The upper producing zone in the reservoir in well B21-2 was intersected at a depth of 2868 feet, only 168 feet deeper than predicted. This accurate prediction is in part fortuitous, but it is within limits imposed by the lithologic information, which suggests the pre-Tertiary rocks would be encountered between 2317 and 3467 feet.

Data from strat. test no. 5 also point out a potential problem in using stratigraphic tests. Had strat. test no. 5 been terminated between depths of 860 and 1060 feet (pl. 6), in the depth range of the negative thermal gradient, it is likely that this part of the thermal anomaly would have been inaccurately and negatively interpreted. A possible negative interpretation would have been that this aquifer was similar to the Southwest Aquifer and did not overlie the reservoir.

A depth of 3200 feet was predicted from strat. test no. 7 information to the 400°F isotherm, and the estimated depth to pre-Tertiary rocks based on lithologic information is between 2850 and 4000 feet. The actual depth to 400°F in well B23-1 is 4320 feet, which is between 1120 and 320 feet deeper than predicted. One reason for the discrepancy is the thermal aquifer noted at 3400 feet in well B23-1. This is the deepest aquifer above the reservoir yet detected at Desert Peak and the most disturbing, as its presence could not be detected from the information obtained from strat. test no. 7. There is no way to outline this aquifer or to separate its thermal halo from that of the reservoir with the data presently available. The result is that temperature data from north and east of wells B21-1 and B21-2 must now be interpreted more conservatively. A second reason for the inaccuracy of the prediction is the presence of several hundred feet of phyllite which behaves as a caprock similar to the rhyolitic unit. Obviously the stratigraphic tests cannot be used to predict the type of pre-Tertiary rocks present at greater depths.

To date the stratigraphic tests have been successful, as they have located sites for successful deep wells. In detail, however, two of the three stratigraphic tests (nos. 2 and 7) did not provide the information necessary to predict problems originating from the movement of thermal waters at greater depths. As more subsurface information becomes available interpretations from the stratigraphic test information are expected to become more reliable.

Presently, the deeper temperature information is the best known geophysical parameter which defines the top of the geothermal reservoir. A map showing the known and estimated depths to 400°F is shown on plate 12. This map was constructed from known deep-hole information, where available, and from extrapolated temperatures and thermal gradients at the bottom of the stratigraphic tests (table 4). The stratigraphic test information should be regarded as minimum depths. In most cases the estimated depth should be in pre-Tertiary rocks.

The heart of the anomaly (pl. 12) is based on known, not extrapolated, data. Also, well 29-1 provides some deep known background in the closely spaced contours southwest of the heart of the anomaly. The outer part of the anomaly is based largely on strat. test nos. 3, 4, and 6. In light of the 3400-foot-deep aquifer encountered in well B23-1, the origin of the heat detected by these holes is not certain. The heat could result from the reservoir or from deeper thermal aquifers located beneath the stratigraphic tests.

The deep thermal anomaly, or the reservoir, is centered beneath S22, T22N, R27E. There are between 2 and 2½ square miles within the 4000-foot contour and 7 or 8 square miles within the 5000-foot contour (pl. 12). This map suggests that the Desert Peak geothermal reservoir could be several square miles in size. Only to the southwest of the anomaly are the contours closely spaced, indicating an obvious possible northwest-trending reservoir boundary. This boundary is shown in a cross-sectional view on figure 20. On the other sides of the anomaly the stratigraphic tests and contours are too widely spaced to reliably suggest reservoir boundaries.

Comparison of the shallow temperature-gradient map (pl. 1) with the map showing the estimated depth to 400°F (pl. 12) shows that the deep thermal anomaly is not located beneath the highest near-surface gradients. It is offset about 2 miles, and compared to the near-surface anomaly the deep anomaly is quite small.

Temperature data from stratigraphic tests and geochemical information indicate that Desert Peak and Brady's are two separate geothermal systems. Strat. test nos. 4 and 8 show that the isotherms between the two systems plunge to substantially greater depths than they would if the systems were connected. Additionally, geochemical data support this interpretation (see section of this report on geochemistry).

## THE DESERT PEAK RESERVOIR

In this report the term reservoir is considered to be that volume of rock above a depth of 10,000 feet which gives an isothermal temperature profile with a

temperature near 400°F. Wells deeper than 10,000 feet in this area are unlikely to be profitable at the present time. The isothermal profile is assumed to be the result of geothermal fluids convecting in fractures. Of course, large fractures, which are referred to as producing zones within the reservoir, must be intersected if a well is to be successful. This nomenclature is essentially the same as the term "geothermal resource" proposed by Muffler and Cataldi (1977). The producing zones in the Desert Peak reservoir consist of fractures in competent pre-Tertiary rocks.

Facca and Tonani (1967) have proposed that a caprock is necessary for a geothermal reservoir to exist. If so, the caprock at Desert Peak is variable. Near wells B21-1 and B21-2 the Tertiary rhyolitic unit would be the caprock, and drilling has demonstrated that the rhyolitic unit is generally impermeable. Of the eight drill holes which have penetrated this unit, severe lost-circulation problems were encountered only once, in strat. test no. 2. In well B23-1 the rhyolitic unit and the pre-Tertiary phyllite, which has escaped significant thermal metamorphism, are likely caprocks.

The producing zones of the reservoir in well B21-1 are well documented. They were characterized by severe lost-circulation problems and other difficulties while drilling. Circulation was lost at depths of 3638, 3891, 3965-70, and 4000 feet. After circulation was lost at 3891 feet, the drilling fluid was displaced with nitrogen and the well flowed without further assistance for 41 hours before being shut in. Below 3891 feet circulation was accomplished by use of aerated water as the drilling fluid. The driller reported the first 8 feet below 3891 feet to be highly fractured. Below 3891 feet the well produced large amounts of water and steam during drilling, so it is possible that any deeper fractures were not detected by the driller. The data obtained during drilling show that fractures above 3899 feet are capable of supplying large amounts of fluid to the surface. Because very little data were obtained during the 41-hour flow test nothing can be said about the relative productivity of fractures above and below 3899 feet.

A suite of logs was run to total depth in well B21-1. No cores were taken. The two most definitive and useful available logs for locating fractures are the spontaneous-potential (SP) and sonic logs (fig. 27). The SP log shows relatively large positive deflections between 15 and 75 millivolts at depths of 3641, 3780, 3850, 3890, 3938, 3975, 4020, 4055, and 4090 feet. These deflections are interpreted as the result of moving water creating a streaming potential (Dakhnov, 1962). The sonic log shows the known fracture zones as irregular, low-velocity intervals. Cycle skipping is common within and between the known fracture zones. Below 3638 feet the sonic log obviously changes character. On the sonic log the largest fractures or fracture zones are present at 3641, 3888-3900, 3940, and 4020 feet. Several smaller or less clearly defined fractures are present at 3780, 3850, and 3982 feet. Other fractures are suggested by this log but require corroborating evidence to be clearly recognized. Examples occur at 4055 and 4085 feet.

The correlation between the driller's log, the sonic log, and the SP logs leave no doubt as to the location of the major fractures encountered by well B21-1. The con-

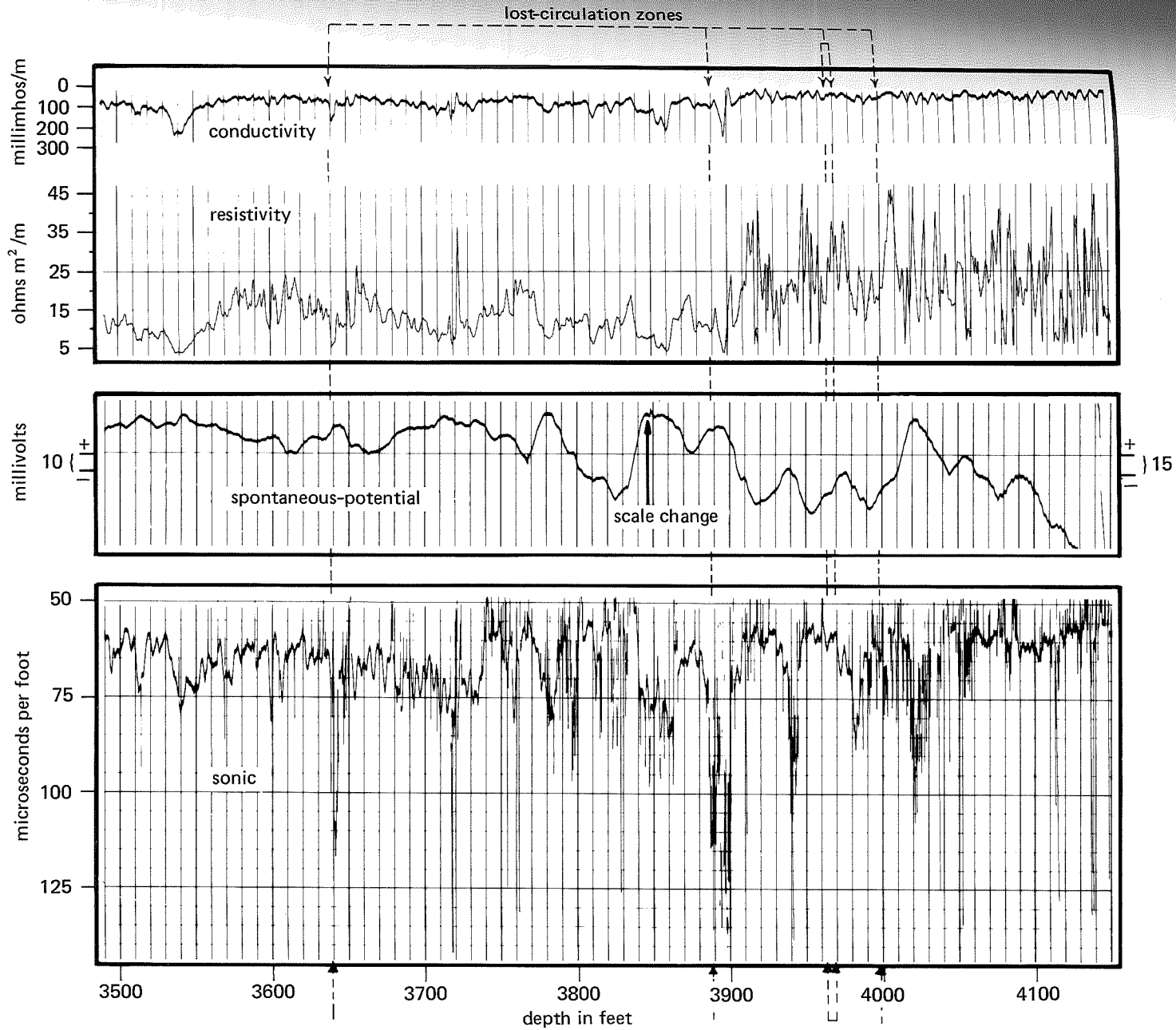

FIGURE 27. Selected geophysical logs showing the producing zones in Desert Peak well B21-1.

ductivity and resistivity logs do show a few of the largest fractures, such as those at 3641, 3855-3860, and 3898 feet, but without supporting data most of the fractures do not show up clearly on these logs.

The producing interval in the reservoir at well B21-1 is at least 449 feet thick (between 3641 and 4090 feet deep). The total thickness of the reservoir below 4150 feet cannot be presently estimated. The logs suggest that the larger fractures or fracture zones comprise less than approximately 20% of the total thickness of the known reservoir. The cuttings from the reservoir usually lack any evidence of shearing and faulting. Two notable exceptions occur at 3895 and 3940 feet, where fault gouge and slickensides are abundant. These depths compare well with known fractures. The cuttings also suggest a lack of secondary minerals such as quartz or calcite filling large veins. Most of the known fractures in well B21-1 are within the greenstone; however, the two fractures at 3780 and 3850 feet appear to be in metasedimentary rocks.

The reservoir geology in well B21-2 appears to be similar to that in well B21-1, although it is not as well documented. Circulation was lost while drilling at depths of 2871 and 2889 feet. At 2894 feet attempts were made to flow the well. Some fluid was produced, but the well did not continue to flow without assistance, suggesting that a large share of the fluids produced by well B21-2 enter the well bore below 2894 feet. Below 2889 feet circulation was never regained, with the exception of cement chips while drilling out a plug. A core was taken between depths of 2937 and 2949 feet and is the only reliable information obtained below 2900 feet. Well B21-2 was logged to 2900 feet, and after logging the hole was deepened. However, when the hole was terminated at 3192 feet the mobilization of a logging truck for only 292 feet of new data could not be justified.

The response of the sonic log to the two known fractures at 2871 and 2889 feet in well B21-2 is similar to the response shown in well B21-1 (fig. 28). The fractures in well B21-2 show up well on the conductivity log, moderately well on the resistivity log, and poorly on the SP log. The fracture at 2871 feet has virtually no expression on the SP log and the fracture at 2889 feet is characterized by a 10-millivolt negative deflection, which is the reverse of the deflections shown in well B21-1. A caliper log from well B21-2 suggests a large fracture at 2871 feet but none at 2889 feet. These fractures also show up well on the density log as pronounced low-density spikes.

The 4-inch diameter core taken between 2937 and 2949 feet consists of angular fragments of greenstone which were poured out of the core barrel as irregular broken blocks. The largest fragment is the size of a fist and is the only fragment resembling a cylindrical core (fig. 29). This core fragment contains numerous small fractures, most of which are sealed with chalcidony and (or) calcite (Morris, 1978). The small fractures have at least one strongly preferred orientation with a dip of near 30° from horizontal. Several smooth faces on this fragment (which probably represent larger fractures) also dip approximately 30°. The original size of the larger fractures separating the angular fragments is unknown. The faces on the angular fragments are not

coated with secondary minerals. Other less developed, near-vertical fractures are visible on this fragment.

The core is a metamorphosed andesitic breccia of variable green color and texture. The greenstone is pyrolytically altered and contains abundant, finely disseminated pyrite. The core fragments show no evidence of shearing. Slickensides are conspicuously absent; however, slickensides observed in cuttings demonstrate that faulting has played a role in creating some of the fractures at Desert Peak.

An interesting aspect of the Desert Peak geothermal reservoir is that some of the fractures in well B21-2 apparently slowly leak fluids into the well bore, while others apparently produce large quantities of fluids. Figure 30 shows the bottom part of six temperature profiles from well B21-2 which were run over a period of five months between December 12, 1976, and May 15, 1977. All of these profiles show a temperature reversal near the bottom of the well. The depth of the reversal varies from 2900 to 3020 feet. This variation is probably due to operator errors in depth during the continuous wireline temperature surveys. The earliest profile on December 12, 1976, shows a reversal with a temperature decrease greater than 42°F. The last available profile, obtained five months later, shows a temperature decrease of 5°F. During drilling, over 2000 barrels of drilling fluid and a large volume of air were lost to the formation. The temperature profiles show that a large percentage of this fluid entered fractures but did not move very far away from the well bore. During the six months from December 1976 to May 1977, the well was flowed at rates from 288,000 to 456,000 lbs per hour for ten days. A graph (fig. 31) of the temperature decrease below the reversal versus the time after the last large amount of fluid was lost in the well shows that during the flow tests some of the lost drilling fluid gradually returned to the well bore. The temperature reversal decreased more rapidly when the well was flowed than when the well was static. However, even after six months not all of the lost drilling fluid had been removed. An additional complicating factor in analyzing this temperature rebound is that the temperature decrease was greater on May 15 than on March 18; this may be the result of operator or equipment errors in the temperature surveys.

Well B23-1 intersected the geothermal reservoir, but to date it has yielded little information about the reservoir. A detailed discussion of the logging and log interpretation of well B23-1 can be found in Sethi and Fertl (1979) and Benoit and others (1980). As this well was being drilled with water and aerated water, no complete losses of circulation occurred. At depths where the reservoir exists, small fluid losses occurred at 6285 and 6330 feet. At 8485 feet the well began taking 1500 barrels per day of drilling water, and this increased to 2600 barrels per day at 9215 feet when the use of aerated water began. It is possible that all the large circulation losses were in a small interval near 8400 or 8500 feet.

The logs run in well B23-1 have not clearly located any fractures in the reservoir. The sonic log was run, but due to high attenuation caused by aerated drilling fluid, it is of little value. The resistivity and SP logs show no obvious conductive zones or SP shifts where the reservoir is believed to exist.

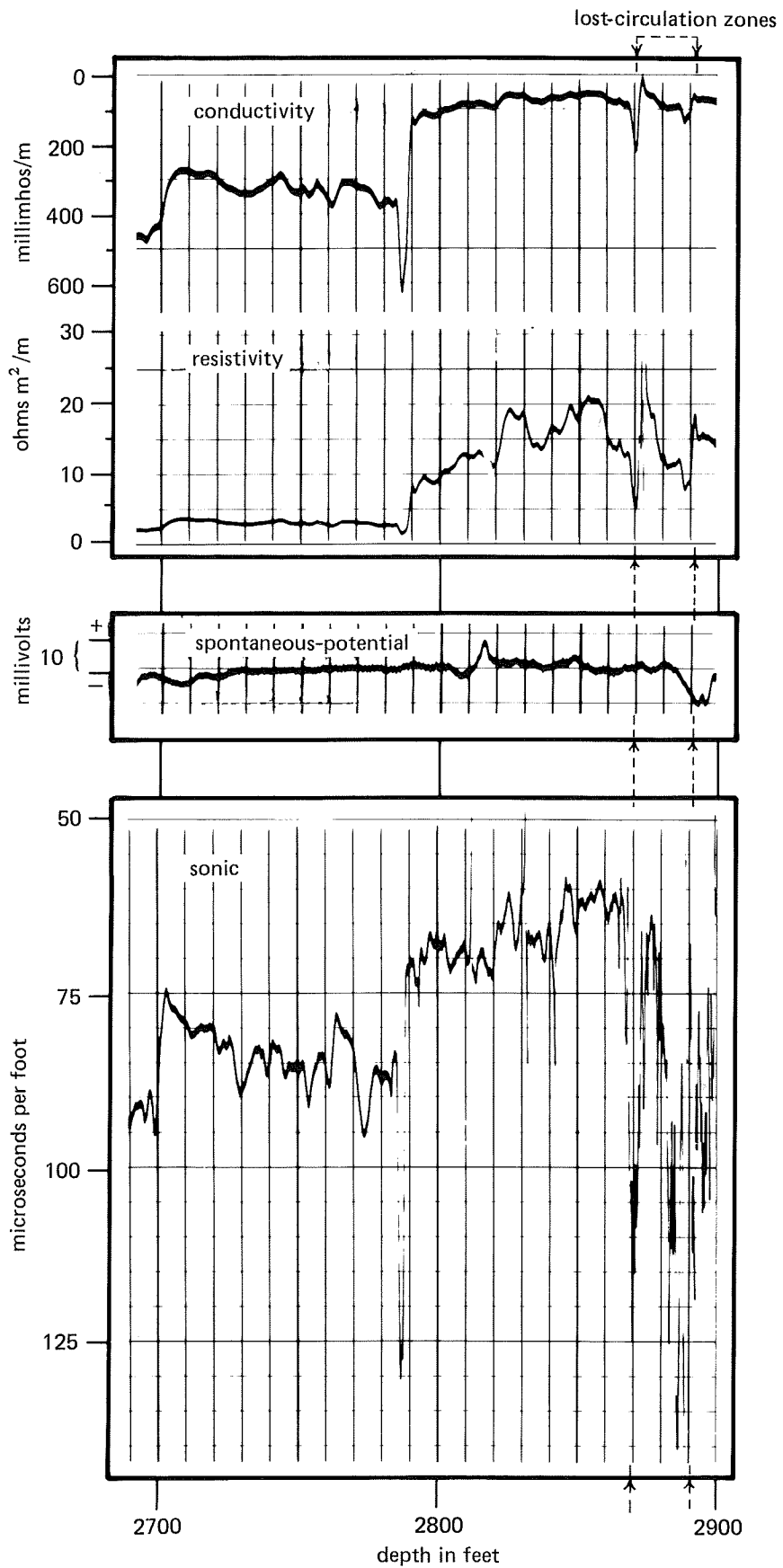
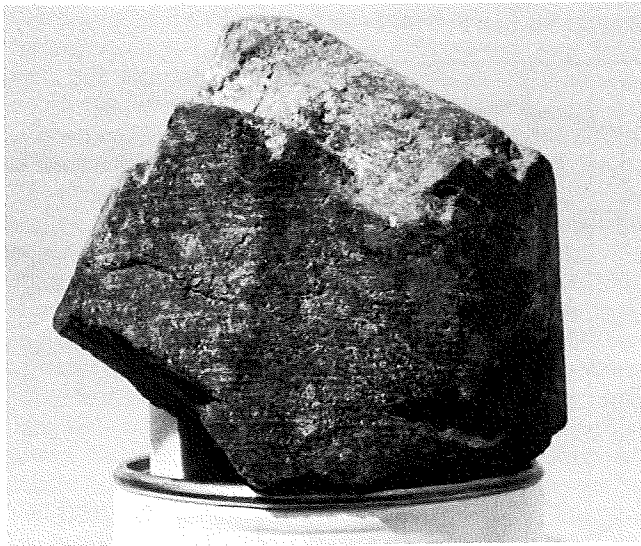

FIGURE 28. Selected geophysical logs showing the producing zones in Desert Peak well B21-2.



**FIGURE 29.** Photograph of greenstone core from Desert Peak well B21-2. Note the prominent fracture set which dips about 30°.

The best available evidence concerning the reservoir in well B23-1 comes from the temperature log. Between 5200 and 8800 feet the temperature is quite constant (pl. 6) and close to reservoir temperatures present in wells B21-1 and B21-2. The reservoir is therefore believed to exist in this interval, suggesting a reservoir thickness of 3500 feet. Between 5200 and 7300 feet about half the rock is chlorite schist and hornfels (fig. 25) and the other half is granite. Between 7300 and 9641 feet granite is the dominant rock type.

The estimated flow rate of 100,000 to 140,000 lbs per hour in well B23-1 is quite low. There is presently an obstruction in the well bore near the bottom of the casing; the severity of this obstruction is unknown. If the obstruction is major, the flow rate is probably much higher and well B23-1 could be a commercial producer. If the obstruction is minimal, then well B23-1 is probably a subcommercial well. Whether the geothermal reservoir near well B23-1 is capable of only limited production or whether it was simply a matter of bad luck that the well never intersected fractures large enough to produce commercial quantities of fluid is unknown.

Wells B21-1, B21-2, and B23-1 have intersected the same geothermal reservoir. Prior to drilling well B23-1, a flow test of well B21-2 resulted in water level and pressure changes in B21-1 within one hour of the beginning of the flow test. This indicates very high permeability between the two wells, which are 4100 feet apart. When well B23-1 was flowed at 100,000 to 140,000 lbs per hour for nine days there were detectable water level changes in wells B21-1 and B21-2 (Yeamans, 1980).

The three wells are relatively widely spaced and were not located with the intention of intersecting known geologic structures such as faults. It is extremely unlikely that all three wells intersect a relatively minor geologic structure or were simply lucky. The reservoir at Desert Peak is believed to represent a large volume of fractured rock. If so, production holes can probably be drilled on a regular grid with the intention of intersecting an extensive horizontal target. The fracture set

which dips about 30° from the horizontal in the one large core fragment (fig. 29) tends to substantiate the other evidence.

Any hard, competent, pre-Tertiary rock at Desert Peak should be capable of maintaining fractures and therefore would be a part of the reservoir. The only pre-Tertiary rock currently believed to be incapable of producing commercial quantities of geothermal fluids at Desert Peak is the phyllite, a soft rock which deforms plastically and is unlikely to maintain fractures for any length of time. Additionally, deep drilling at three other geothermal prospects in northwest Nevada has demonstrated that phyllite probably is not a viable reservoir rock. The amount and distribution of phyllite in the vicinity of the Desert Peak reservoir is largely unknown.

The configuration of the top of the reservoir is indicated by the contours of the estimated depth to 400°F (pl. 12). The configuration of the top of the producing zone or zones within the reservoir cannot be contoured with the two available data points and is likely to be irregular. Reliable data on the top of the producing zone are available only from wells B21-1 and B21-2. The top of the producing zone in well B21-1 at 3638 feet is 1908 feet below the top of the reservoir (400°F isotherm) and 500 feet below the top of the pre-Tertiary rocks. In well B21-2 the top of the producing zone is at 2871 feet, which is 331 feet below the top of the reservoir and only 63 feet below the top of the pre-Tertiary rocks. The depth of the producing zone in well B23-1 is not yet known. The top of the reservoir in well B23-1 is 975 feet below the top of the pre-Tertiary rocks.

To date, the producing zones in the Desert Peak geothermal reservoir have been confined to the pre-Tertiary rocks. The 400°F isotherm, which has been arbitrarily chosen to represent the upper boundary of the reservoir, is generally confined to pre-Tertiary rocks. In well B21-1 the 400°F isotherm rises high into the rhyolitic unit, but it is interpreted to be a minor feature related to a single fault or small fault zone. It is relatively simple to estimate the depth to the top of the reservoir using temperature data. At the present time there is no way to accurately estimate the depth to the top producing zone within the reservoir or to guarantee that all wells in the reservoir will intersect commercial producing zones. The producing zones are fractures. The pattern of fractures interpreted from well B21-1 data indicate that the reservoir is not pervasively fractured; rather, the fractures are irregularly concentrated in what may be discrete faults. Questions as to orientation, age, and distribution of these fractures remain unanswered.

## GEOCHEMISTRY

Geochemistry played no part in discovering the Desert Peak thermal anomaly or in siting the stratigraphic tests and deep production tests, as there is no surface water to sample within the Hot Springs Mountains and only a few seeps are present near the margins of the range. Water-level measurements in the stratigraphic tests have shown that the water table is often deeper than the bottom of most of the shallow

ne one  
ite the  
Desert  
s and  
y pre-  
pro-  
ls at  
orms  
any  
ther  
has  
ble  
lite  
ely

n-  
F  
g  
d  
e

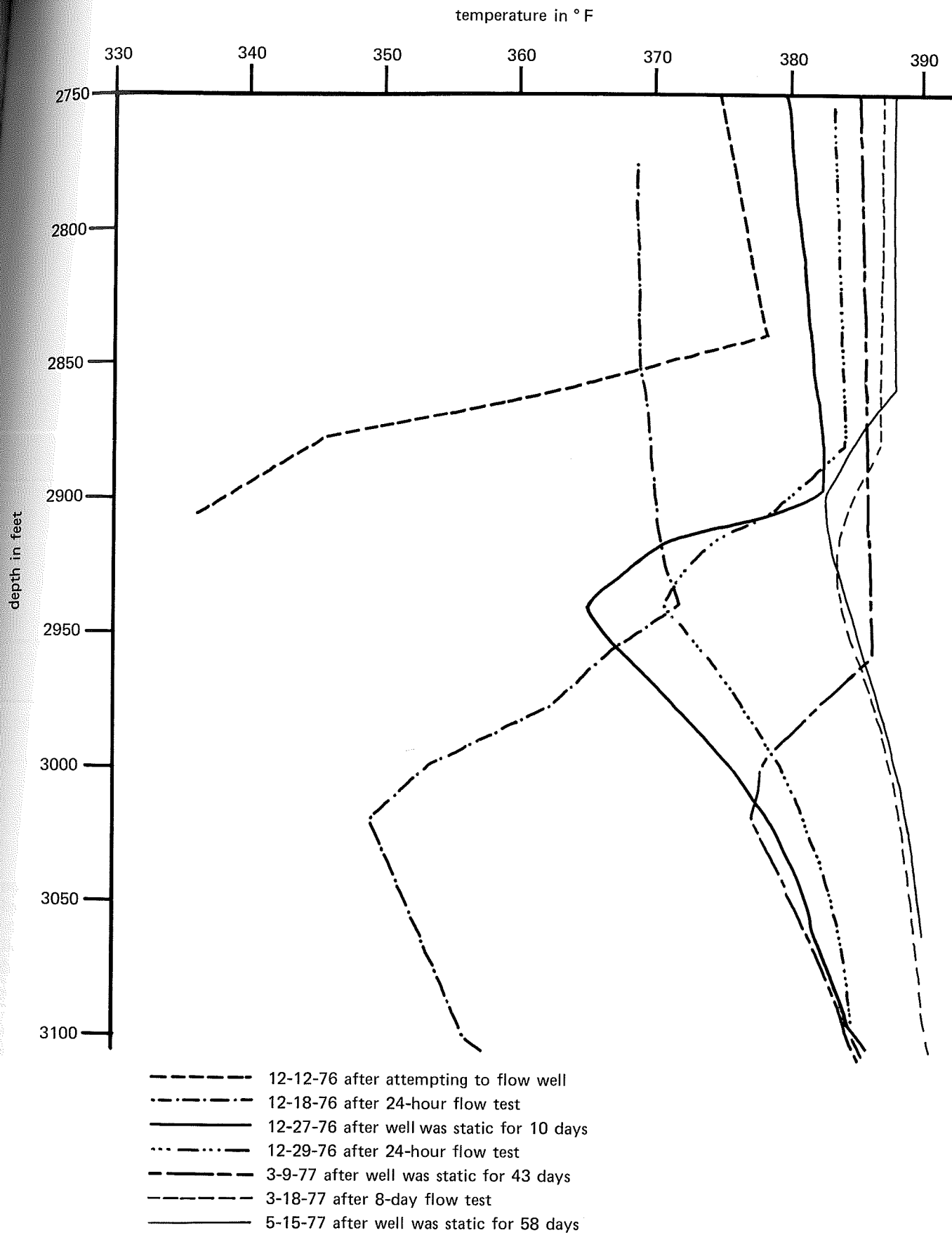

FIGURE 30. Nonequilibrium reservoir temperature profiles of Desert Peak well B21-2.

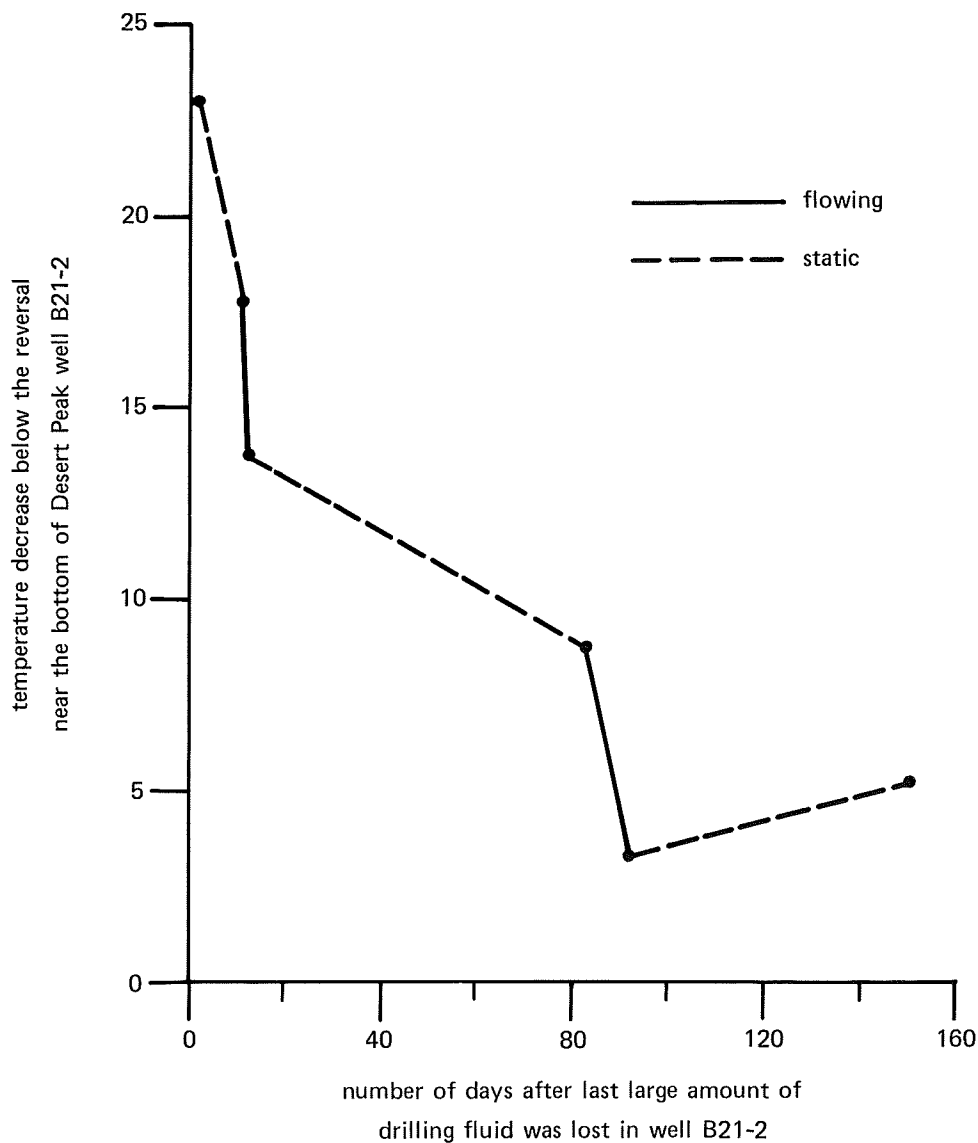

FIGURE 31. Temperature reversal decrease with time in Desert Peak well B21-2 (2-17-76).

temperature-gradient holes drilled within the range. In spite of this paucity of data, the water geochemistry has provided some useful information. The locations of the water sampling sites and chemical analyses of the waters are given in table 5.

#### DATA QUALITY AND SAMPLE COLLECTION

The quality of the geochemical data on table 5 is quite variable for waters in the Desert Peak area. Over the years different techniques have been used in sampling, and several laboratories have performed the chemical analyses. Some analyses were made in the field while others were run in the laboratory weeks or months after the samples were collected. A more serious problem is variability in the sampling techniques for flowing wells. All the samples taken from the wells at Brady's Hot Springs were collected after the steam had separated. The amount of separation appeared to vary from well to well.

In an attempt to prevent significant steam separation in the Desert Peak well samples, they were collected off the flow line and passed through coiled copper tubing immersed in cold water. The samples from well B21-1 were taken from the top of the flow line, and since the free gases are concentrated there, these are not truly representative samples. Samples from well B23-1 were taken from the bottom of the flow line, which is probably depleted in the gases. The samples from well B21-2 probably have the highest quality. They were collected with a sampling nozzle consisting of a small vertical pipe placed inside the flow line; the nozzle has six equally spaced holes on the upstream side through which fluid can enter. Also, these samples should be free of contamination by drilling fluids since this well flowed for more than two months in the fall of 1977.

The water samples collected from the few nonthermal wells and seeps in the area were not altered by preservatives, dilution, or acidification. No chemical measurements on these samples were performed in the field.



TABLE 5. Geochemical data.

Sample	Date	Location	Temp.	Flow rate	Lab or source	Ca <sup>1</sup>	Mg <sup>1</sup>	Na <sup>1</sup>	K <sup>1</sup>	HCO <sub>3</sub> <sup>-</sup>	CO <sub>3</sub> <sup>1</sup>	CO <sub>2</sub> <sup>1</sup>	SO <sub>4</sub> <sup>1</sup>	Cl <sup>1</sup>	SiO <sub>2</sub> <sup>1</sup>	B <sup>1</sup>	Li <sup>1</sup>	SC <sup>2</sup>	TDS <sup>3</sup>	Lab pH	B/Cl ratio	SO <sub>4</sub> /Cl ratio	Remarks
B21-2	3/78	NE/4 NE/4 NE/4 S21,T22N,R27E	320°F	*288,000	Amtech	100	<1	2250	250	50	---	---	98	3700	350	16	1.4	10,720	---	7.57	.0043	.026	Geothermal well; total flow sample collected through a six-point sampling nozzle
B21-2	3/78	NE/4 NE/4 NE/4 S21,T22N,R27E	320°F	*288,000	Phillips	84	0.1	2200	219	34	---	---	88	3500	---	15.1	---	---	6692	7.3	.0043	.025	
B21-1	11/76	C SE/4 S21,T22N,R27E	324°F	*478,000	Amtech	93	0.4	1950	220	85	---	---	131	3600	---	14.0	2	10,920	---	6.86	.0064	.036	Geothermal well; collected after 1 hr of flow from port on top of flow line
B21-1	11/76	C SE/4 S21,T22N,R27E	324°F	*478,000	Phillips	95	0.3	2200	265	132	---	---	96	3600	310	16	---	---	6700	7.2	.0073	.027	
B23-1	11/79	NW/4 SW/4 NW/4 S23,T22N,R27E	228°F	*~114,000	Amtech	120	0.6	3150	357	52	---	---	92	5510	365	29.5	5.6	18,768	---	7.4	.0054	.016	Geothermal well; collected from port on bottom of flow line after 8-day flow
Phillips water well	5/74	SE/4 SE/4 SE/4 S29,T22N,R27E	180°F	7 <sup>5</sup>	Morse	53	0.5	2650	130	180	64	---	420	3870	200	10	---	---	7647	9.6	.0025	.109	Thermal well; water pumped from a depth of 200 feet
Well	10/61	SE/4 NE/4 SE/4 S30,T22N,R27E	65°F	none	Harrill (1970)	165	14	2710	47	138	---	---	4430	---	---	---	---	13,200	---	7.5	---	---	Nonflowing, nonthermal well
USGS hole	11/74	C SW/4 SE/4 S25,T22N,R26E	---	none	Morse	100	10.5	1520	140	158	---	---	71	2470	55	9.8	---	---	4675	7.6	.0040	.028	Nonflowing, nonthermal well; sample bailed out of 2-in. steel pipe
Well	10/76	E/2 NE/4 NE/4 S35,T22N,R26E	60°F	marsh	Amtech	150	15	2900	235	191	---	---	112	4400	73	19.9	1.8	13,550	---	7.86	.0045	.025	Seep or low-volume, nonthermal spring; 12-ft by 12-ft dug well lined with boards
Well	5/74	NE/4 SE/4 SE/4 S34,T22N,R26E	---	none	Amtech	129	25.7	2810	218	201	---	---	129	4510	56	15.4	4	11,890	8527	7.45	.0006	.027	Nonflowing, nonthermal well; 2-ft by 2-ft dug well lined with boards
Mule Train Mine	1/74	SW/4 SW/4 SE/4 S29,T23N,R28E	55°F	none	Morse	182	18	4220	328	241	---	---	400	6542	28	20	---	---	11,886	7.7	.0031	.061	Nonflowing, nonthermal well; 35-ft deep dug well-lined with boards
Seep	1/74	C N/2 NW/4 S13,T22N,R28E	40°F	seep	Morse	77	25	4110	292	322	---	---	1133	5923	38	20	---	---	11,814	7.9	.0033	.191	Seep or low-volume, nonthermal spring
Brady's Hot Springs	10/76	S/2 NE/4 SW/4 S12,T22N,R26E	170°F	none	Amtech	33	<1	930	72	45.7	---	---	446	1200	152	5.6	0.8	3970	---	7.6	.0047	.371	Thermal spring; collected from a deep crack in ground
Flowing geothermal well Brady SP no. 1	1/76	NW/4 SE/4 SE/4 S12,T22N,R26E	boiling	7 <sup>20</sup>	Amtech	66	<1	930	60	18	13.7	235	1500	---	8.3	1.2	5390	---	8.6	---	.372	.157	Geothermal well; collected after steam separation
Flowing geothermal well	1/76	NE/4 NE/4 SW/4 S12,T22N,R26E	boiling	7 <sup>60</sup>	Amtech	60	0.3	970	55	30	18.1	323	1440	---	---	1.5	5400	---	8.75	---	---	.224	Geothermal well; collected after steam separation
Brady 8 well	---	NE/4 SE/4 NW/4 S12,T22N,R26E	boiling	7 <sup>60</sup>	Amtech	46	0.5	980	47	57.6	9.1	314	1470	200	5.8	1.4	5000	---	8.55	---	.0039	.213	Geothermal well; collected after steam separation

<sup>1</sup>Measured in parts per million.<sup>2</sup>Specific conductance is a measure of the ability of water to conduct an electrical current and is expressed in micromhos per centimeter ( $\mu\text{mhos/cm}$ ) (from Garside and Schilling, 1979).<sup>3</sup>TDS is total dissolved solids.<sup>4</sup>Given in lbs per hour.<sup>5</sup>The field pH was 7.0.<sup>6</sup>The field pH was 6.85.<sup>7</sup>Measured in gallons per minute.

The geochemical data from the samples are good for general comparisons between samples and for determining gross water types. These data, however, probably are not adequate for detailed or highly specialized geochemical studies.

The basic water chemistry of Brady's Hot Springs was known prior to 1973 (Middleton, 1962; Harrill, 1970). In view of the previously measured subsurface temperature of 414°F (table 1), the chemical data only agreed with known thermal data. The water geochemistry at Brady's was not a factor in Phillips' decision to begin exploration in the area. In fact, the known scaling problem in the Brady's wells was regarded as a somewhat negative factor of the prospect (Gar-side, 1974).

In the Desert Peak area the available geochemical data were essentially ignored prior to the drilling of well 29-1, principally because there were no thermal springs which could be sampled and easily interpreted. After well 29-1 was completed in May 1974, additional data were obtained and evaluated more thoroughly (Benoit, 1974; Erdman, 1974). The primary result of this study was the realization that near the western and south-western margins of the northern Hot Springs Mountains, two distinct, relatively homogeneous waters are present. The first is sodium chloride water from Brady's Hot Springs which rises along Brady's Fault and flows through alluvium to the west into Hot Springs Flat. From there the water flows southward through a narrow gap into the northwest corner of Eagle Marsh. This flow pattern was later confirmed by and shown in greater detail with hydrologic information by Olmsted and others (1975). The Brady's thermal water is characterized by laboratory pH's between 7.6 and 8.75, conductivities between 4000 and 5800  $\mu$ mhos, and  $SO_4/Cl$  ratios between 0.16 and 0.37 (table 5). The Brady's wells appear to be more saline than the springs; however, at least part of this disparity is due to steam separation in the well samples prior to sample collection.

The second water type is found to the east of the center of Eagle Marsh; it too is a sodium chloride water, and it is characterized by pH's between 7 and 8, conductivities between 11,700 and 14,000  $\mu$ mhos, and a  $SO_4/Cl$  ratio near 0.025. Both water types have the same B/Cl and Li/Na ratios. Now that water samples from the Desert Peak geothermal reservoir are available and the Southwest Aquifer has been defined, it is believed that all but one of the water samples collected east of Eagle Marsh originated in the Desert Peak reservoir. This sample, no. 22/26-25c, was discussed in the section of this report on the near-surface thermal aquifers. The sample from well B21-2 and the unnamed well 22/26-34d (table 5) on the southeast side of Eagle Marsh are strikingly similar, especially since they are located 6 miles apart; there has been ample time for evaporation, mixing, and dissolution or precipitation of minerals during transport in the Southwest Aquifer. Russell (1885) mentioned that the brine for the Eagle Marsh salt works was supplied from springs on the east side of the marsh. Assuming that the chemistry or hydrology has not changed during the past 100 years, the salt collected at Eagle Marsh would have originated in the Desert Peak geothermal reservoir and would have been carried to Eagle Marsh via the Southwest Aquifer.

Two water samples were collected outside the north-east lobe of the thermal anomaly (table 5). Both samples are noticeably more saline than the samples from wells B21-1 and B21-2, but the paucity of geochemical data in this area and the poor quality of the sampling site precludes any firm conclusions regarding the origin or history of these two water samples.

The analyses for wells B21-1, B21-2, and B23-1 show significant variation, both between laboratories and between wells. Reservoir tests have proven that the three wells are in the same reservoir, and similar chemistry is expected. The samples from well B21-1 are suspect, as the well was flowed at its maximum rate for only one hour and may not have ejected all the lost drilling fluids before the samples were taken.

The available geochemical data neither prove nor disprove a genetic relationship between the Brady's and Desert Peak thermal waters. Geologic evidence suggests that they are not genetically related. The B/Cl and Li/Na ratios are similar, which may indicate a common or similar origin (White, 1970). The greatest and probably most significant chemical differences are in the  $SO_4/Cl$  ratios and in salinity variations. However, these differences do not preclude a geochemical model in which the Brady's thermal water represents Desert Peak thermal water which has been diluted by injection and condensation of steam. This dilution would not greatly affect the B/Cl or Li/Na ratios, but it would reduce the salinity and could alter the  $SO_4/Cl$  ratios by addition of  $H_2S$  in the steam (with later oxidation to  $SO_4$ ).

However, there is no available geological evidence to support this model. None of the wells, stratigraphic tests, or temperature-gradient holes in the region have revealed temperatures near the boiling curve for pure water, which implies that steam is not presently forming underground. The area between Brady's and Desert Peak is characterized by relatively low thermal gradients. Strat. test no. 4 (pl. 12) indicates that the isotherms are depressed in this region. Also, the Brady's thermal system is capable of producing large volumes of fluid (table 1), requiring an extremely large volume of steam to form the very dilute condensate. The Brady's thermal water is from one-third to one-half as saline as the Desert Peak water; it is difficult to believe that one-half to two-thirds of Brady's water is steam condensate. Available evidence therefore suggests that Brady's and Desert Peak are two separate geothermal systems.

## SCALE

Calcium-carbonate scale is a problem in all producing wells at Brady's and Desert Peak. Therefore, an unknown though probably small amount of calcium and bicarbonate are removed before sampling. A spectrographic analysis of the scale in well B21-2 is shown on table 6. Chemically, the scale is relatively pure calcium carbonate. A study of chips with a scanning electron microscope shows that a disordered, mixed-layer montmorillonite-chlorite clay has precipitated on the exposed surface of the scale after flow ceased and possibly during flowing, to a small extent (Petrovich, 1979).

TABLE 6. Chemical analysis of scale from Desert Peak well B21-2 (plasma emission spectrometry).

Element	Wt. %
Calcium	34.83
Silicon*	0.29
Iron	0.116
Manganese	0.035
Strontium	0.62
Magnesium	0.096
Aluminum	0.38
Titanium	0.010
Barium	0.010

\*Analysis by neutron activation analysis.

In well B21-2 the scale forms in the well bore in response to boiling below a depth of 780 feet. Figure 32 shows a nonequilibrium temperature profile of well B21-2 obtained about three hours after the well was shut in following a 24-hour flow test. Between 740 and 520 feet the temperature decreases 58°F; this temperature drop reflects partial boiling of the thermal fluid. During boiling, calcite supersaturation occurs because most of the dissolved carbon dioxide in the water separates with the relatively small proportion of steam (Ellis and Mahon, 1977). After well B21-2 had flowed for about 70 days the flow rate decreased from 313,000 to 133,000 lbs per hour and the wellhead pressure decreased from 83 to 33 psig. These decreases reflect scale buildup in the well bore. During subsequent clean-out operations on the well, abundant calcium carbonate scale was present between depths of 781 and 1030 feet.

Well B21-1 has been flowed at its maximum rate for only one hour and no trustworthy temperature profile was obtained immediately after the flow test. Therefore, the presence of scale in this well has not been proven, but it is thought to be probable.

Calcium carbonate appears to accumulate faster in the producing wells at Brady's, and the scale is found in

the discharge pipes, wellheads, and upper parts of the holes (Garside, 1974). The Geothermal Food Processors' plant has avoided the scale problem by pumping Brady no. 8, the well which provides fluids to the plant. With pumping, pressure is maintained in the well bore and pipeline, effectively prohibiting boiling and scaling. No reliable data on noncondensable gases have been obtained from the Desert Peak wells. Attempts to collect gases have been severely hampered by an apparently low gas content.

### ISOTOPES

Stable hydrogen and oxygen isotopes have been determined from total discharge samples from well B21-2 by both the USGS and Phillips Petroleum Company. Both data sets agree well and are shown on table 7. There are no nonthermal springs in the immediate area which can give reliable background isotopic ratios for comparison purposes. At the present time these data can only be compared with isotope ratios from other hot springs in the Carson Sink area, which are also shown on table 7. As they are similar to those from well B21-1, it is unlikely that the water in the Desert Peak geothermal reservoir is of a different origin from other waters in the Carson Sink area. Presently there is no evidence to postulate a nonmeteoric origin for the Desert Peak thermal water.

### GEOLOGY

The surface geology in the immediate vicinity of the Desert Peak geothermal wells consists principally of Quaternary alluvium and wind-blown sand. Evidence concerning the relationship of the geology and the geothermal reservoirs comes mainly from mapping in adjacent areas and from drill-hole data. The lack of concentrated deep information has hampered analysis of structural control of the reservoir itself, and available geophysical data suggest that some amount of subsur-

TABLE 7. Isotope and background data.

Isotope data—Desert Peak				
Date	Laboratory	Isotope and value		
		<sup>1</sup> D	<sup>18</sup> O	
16 Mar 77	USGS	-117.8	-12.52	
16 Mar 77	Phillips	-115.1	-12.8	
18 Mar 77	Phillips	-114.6	-12.5	
5 Nov 77	Phillips	-116.0	-12.9	
12 Nov 77	Phillips	-115.6	-12.9	
Background data				
Spring name	Location	Temperature	Isotope and value	
			<sup>1</sup> D	<sup>18</sup> O
Lee Hot Springs <sup>2</sup>	S34,T16N,R29E	190°F	-125.8	-13.21
Hazen Hot Springs <sup>2</sup>	S18,T20N,R26E	187°F	-121.5	-13.3
Flowing well in Stillwater <sup>2</sup>	S7,T19N,R31E	205°F	-110.2	-12.36
Soda Lake shallow research well <sup>2</sup>	S28,T20N,R28E	212°F	-109.3	-13.46
Soda Lake shallow research well <sup>2</sup>	S32,T20N,R28E	72°F	-111.3	-14.56

<sup>1</sup>Value per mil.

<sup>2</sup>Data from Mariner and others (1975).

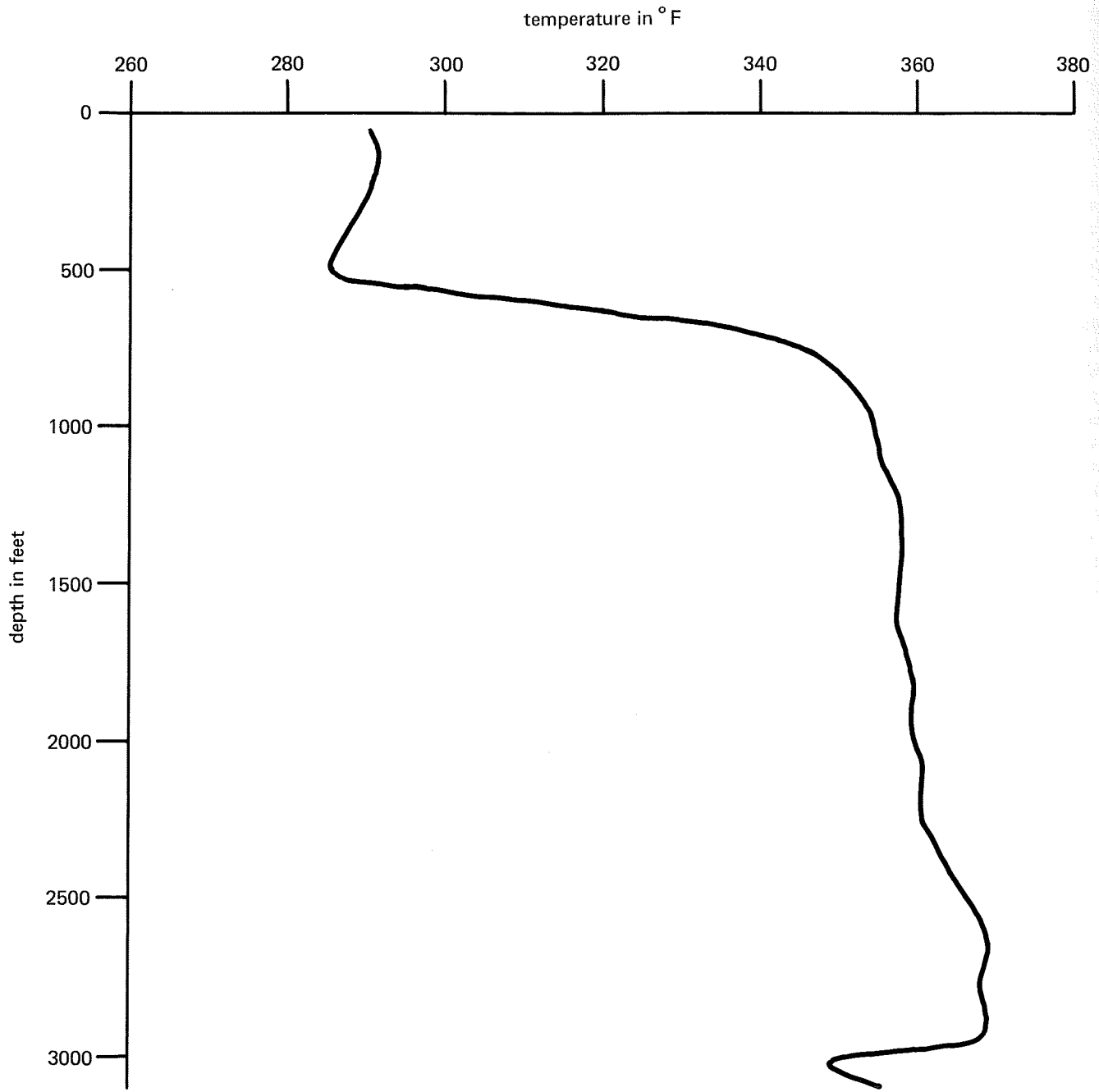

FIGURE 32. Nonequilibrium temperature profile of Desert Peak well B21-2 (obtained 3 hours after a 24-hour flow test).

reservoir control may be related to events or structures expressed in either the drill holes or at the surface. Nevertheless, some inferences can be made which give a first approximation of the relationship between geology and geothermal resource localization. Information from the drill holes, supported by mapping, suggests that the Desert Peak geothermal field may be situated at the intersection of two structural features, an east-northeast fault system and a north-northeast fault pattern so characteristic of the Basin and Range physiographic province (fig. 2). There is no surface evidence to suggest that the northwest-trending Walker Lane (fig. 2) is involved, but gravity data discussed later suggest that structures of similar trend exist in the area. The stratigraphy, as deduced from geologic logs and from mapping, is complex. To date detailed correlations from well to well and outcrop to outcrop have been generally unsuccessful, owing to a lack of any areally persistent marker beds, discontinuous exposures, and a remarkably monotonous volcanic section. Also, the stratigraphy was studied only to the extent necessary to complete mapping. The correlations that have been made in the wells are of a general nature (with one exception), but even the generalities have proven helpful. The rock names used herein are based on hand-specimen examination, geophysical log response (particularly the gamma ray), microscopic examination of cuttings, and in a few cases, thin sections. Because the majority of volcanic rocks are porphyritic with aphanitic groundmasses, the assigned names may not correctly reflect the chemical composition of the rocks.

Five major rock types are exposed in the northern portion of the Hot Springs Mountains: 1) a Tertiary(?) hornblende-quartz diorite intrusive near the Desert Queen Mine (pl. 13); 2) a basal Tertiary sequence of silicic volcanic rocks ranging from rhyolitic to andesitic ash flows, lava flows, and tuff breccias; 3) Tertiary intermediate to mafic volcanic rocks, principally andesite and basalt; 4) lacustrine and fluvial Tertiary sedimentary rocks; 5) Quaternary Lake Lahontan sediments, alluvium, playa deposits, and sheet and dune sands.

The northern Hot Springs Mountains are the type locality for the Truckee, Desert Peak, and Chloropagus Formations, all Tertiary. The Truckee Formation was named by King (1878) for exposures in the northeastern part of the Hot Springs Mountains. Axelrod (1956) defined the Desert Peak and Chloropagus Formations as part of an analysis of the fossil flora of the area, and at the same time he clarified the stratigraphy of the Truckee Formation, which in its type locality does not match King's description (Axelrod, 1956). The Tertiary and Quaternary rocks in the area rest unconformably upon Mesozoic(?) metavolcanic, metasedimentary, and intrusive rocks. The Mesozoic rocks are not exposed in the Hot Springs Mountains but are important as they contain the geothermal reservoir.

## ROCK UNITS

### MESOZOIC

Rocks thought to be Mesozoic were penetrated by the deep tests and include metamorphosed and altered

basalt and andesite, quartzite, marble, phyllite, hornfels, and possibly a rhyolitic tuff (in well 29-1, fig. 7). Metamorphosed and altered basalt or andesite (referred to collectively as greenstone) predominate in the successful wells, whereas to date the unsuccessful wells encountered a significantly larger percentage of metasedimentary rocks. The reason for this variance is not presently understood. The greenstones which contain the producing zones of the reservoir are characteristically dull, dark-green aphanitic rocks which have been altered to fine-grained chlorite, sericite, calcite, quartz, and other secondary minerals (Morris, 1978). Relict porphyritic texture can be found, but in general the rocks appear to have been aphanitic and microcrystalline. In some instances there is a suggestion of a metamorphosed breccia texture. Fractures in the greenstones are usually free of calcite or silica coatings (fig. 29). Rarely, older(?) fractures cemented with silica can be inferred from drill cuttings samples, but these interpretations are tenuous.

The age of the sequence is assumed to be Mesozoic and possibly Juro-Triassic, on the basis of the similarity between well cuttings and rock exposures in the Trinity and West Humboldt Ranges (Willden and Speed, 1974). Some of the metasedimentary rocks may be in part correlative with rocks of the Auld Lang Syne Group, but incomplete understanding of Mesozoic stratigraphy in the region, and particularly in the wells, precludes any attempt at correlation at present.

### TERTIARY RHYOLITES

The oldest Tertiary rocks in the area consist of a sequence of silicic ash-flow tuffs, lithic tuff-breccias, and lava flows(?). Rock composition varies from andesite to rhyolite, but rhyodacite and dacite predominate. Surface exposures are poor and appear discontinuously from Rhyolite Ridge (informal name, pl. 13) northeasterly to the vicinity of Cinnabar Hill. Correlation of individual units from outcrop to outcrop or with occurrences in the wells is difficult, and only a few units have been correlated with confidence from well to well. Areal distribution of the rhyolites is unknown, although judging from well intercepts the sequence thins southward. The rhyolite sequence is 2800 feet thick in the easternmost well, B23-1, and thins to 1250 feet in well 29-1 (fig. 33).

The sequence is roughly divisible into three parts: a lower rhyolite to rhyodacite series, a medial dacite series with minor andesite, and an upper rhyolite to rhyodacite series. The lower rhyolites range from white to lavender and are commonly vitrophyric. Rhyodacites are generally gray, gray-green, and varying shades of pink to purple. In both of these types, lithic fragments are visible in thin section but difficult to identify in cuttings. Lithic-rich rocks appear to be more prevalent in the upper portion of the rhyolite to rhyodacite sequence. The medial dacite and andesite sequence is characterized by flows containing distinct feldspar phenocrysts in a brown, gray, and rust-colored aphanitic matrix. The upper sequence of rhyolites and rhyodacites consists of several units of gray to violet,

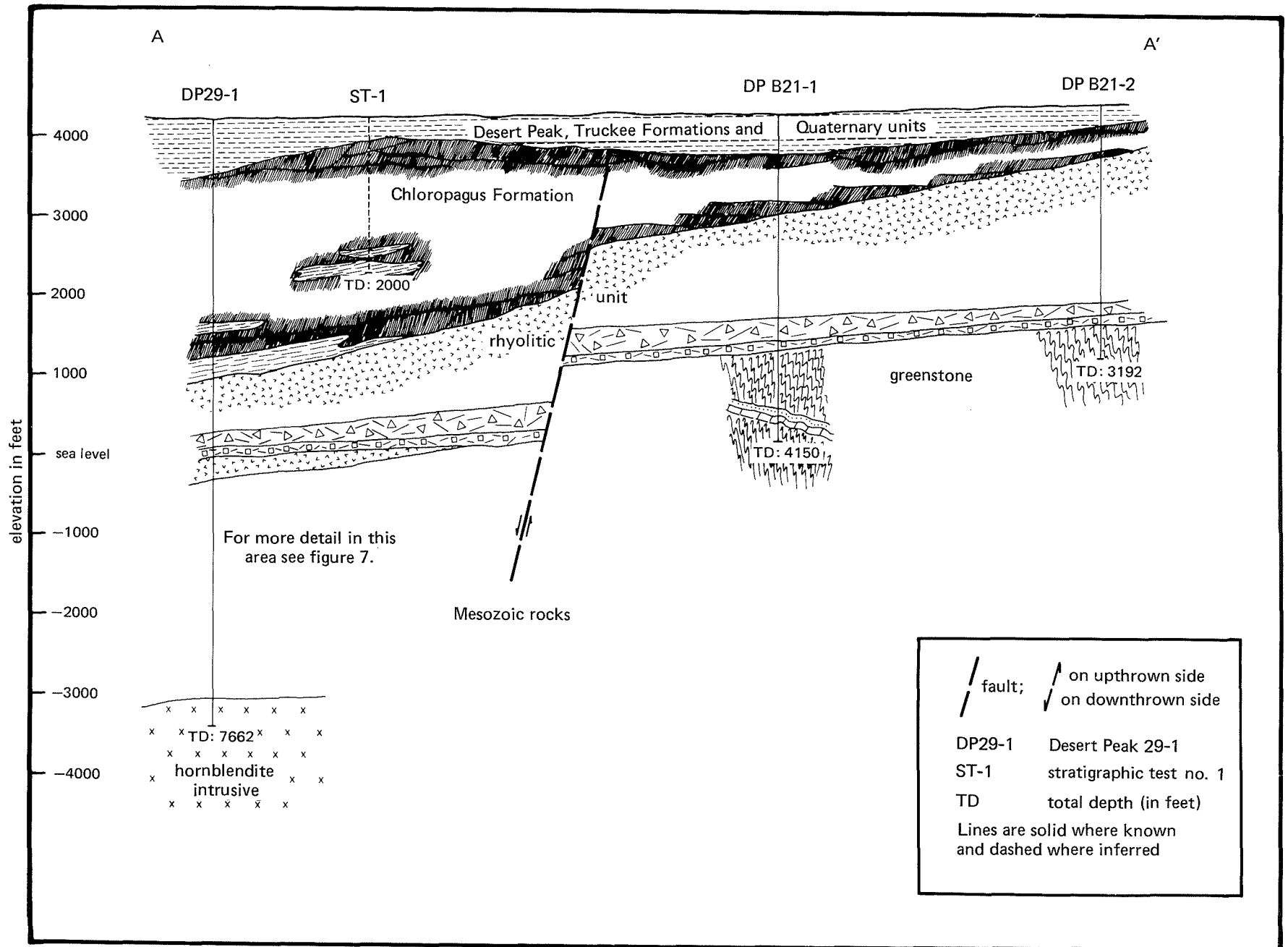

FIGURE 33. Geologic cross section A-A' (see plates 12 and 13 for location of A-A').

white, and green ash-flow tuffs. Lithic fragments, usually of more mafic rocks but also as finer-grained equivalents of the parent rock, occur with varying frequency in cuttings.

Two units, a fine-grained white quartz vitrophyre over a distinctive lavender rhyodacite, at or near the base of the sequence are correlative in wells 29-1, B21-1, and B21-2 (fig. 33). These two units are the only positive correlations that have been made within the rhyolitic unit.

Examination of well cuttings reveals the presence of small gravel interbeds at the top of the rhyolite sequence. The gravels consist of fragments of quartz and rhyolitic rocks. These gravels are considered to be evidence of some amount of relief and erosion and, therefore, of unconformity between the rhyolites and the overlying Chloropagus Formation.

No attempt has been made to correlate these rhyolites with other ash-flow tuffs in the region. Some parts of the rhyolite sequence may be correlative with units in the Old Gregory Formation (Axelrod, 1956), with rocks described by McJannet (1957), with the ash-flow tuff subdivision of the now abandoned Hartford Hill Rhyolite (Bingler, 1978), or with units in the Yerington area (Proffett and Proffett, 1976).

The rhyolite sequence underlies the Mio-Pliocene Chloropagus Formation and rests unconformably on Mesozoic(?) rocks. The rhyolites are therefore assumed to be Miocene, but lower units may be as old as Oligocene.

## CHLOROPAGUS FORMATION

A series of andesitic to basaltic flows, agglomerates, and tuff-breccias with minor intercalations of water-laid tuffs and shales was named the Chloropagus Formation (Axelrod, 1956) for exposures at Green Hill in the northern part of the Hot Springs Mountains. Outcrops of this formation are excellent in the western foothills of the mountains and also in isolated areas southwest of Cinnabar Hill. The Chloropagus Formation consists chiefly of dark-brown, black, green, and reddish vesicular basalt and andesite flows. Water-laid tuffs, tuff-breccia, tuffaceous sandstone, and siliceous shale form prominent interbeds of extremely local character near Green Hill. These intercalated sediments almost always include a tuffaceous component, and their dominant lithology is tuffaceous siltstone or shale with thin interbeds of tuffaceous sandstone. The shales are locally silicified, and from one such shale Axelrod (1956) recovered the Chloropagus Flora.

Formation thickness varies from approximately 400 feet in the northern part of the Hot Springs Mountains to 2600 feet in well 29-1 (fig. 33). Axelrod managed to piece together 1920 feet from surface exposures which, as with other formations in the area, are highly faulted. The preponderance of volcanic rocks of similar character make the determination of stratigraphic position extremely difficult; also, the intercalated lakebeds cannot be trusted to occur with any lateral continuity. Correlations within the Chloropagus Formation are difficult among the stratigraphic tests and deep wells. The formation thickens southward between wells B21-2 and

29-1, possibly indicating a source in that direction. Interestingly, Axelrod also implied a volcanic source to the south on the basis of current directions in the intercalated sediments. However, the rapid change in thickness from 400 to 2600 feet over a distance of slightly more than 2 miles may reflect original topography and undoubtedly has been enhanced by faulting and erosion.

The base of the Chloropagus Formation is not exposed in the Hot Springs Mountains. At the north end of Rhyolite Ridge the contact between the unnamed rhyolite unit and the Chloropagus Formation is veneered by alluvium, but rock attitudes imply a conformable relationship. Elsewhere, however, variation of rock types near the inferred contact suggests that some amount of unconformity exists between the Chloropagus Formation and the underlying rhyolites. The extreme thickness variations of the formation in the geothermal wells also agrees with an unconformable relationship.

Axelrod (1956) placed the age of the Chloropagus Formation at Early Clarendonian, or Mio-Pliocene, in age. Lower portions may be as old as Barstovian, or late middle to late Miocene. Radiometric dates by Evernden and James (1964) and Bonham (1969) of 13.9 m.y. and 14.5 m.y., respectively, support the dates for the lower portions.

The sections described by Axelrod and the sections encountered by the geothermal wells differ somewhat, and in places they are noteworthy for their diversity. In general, the formation has a greater proportion of truly volcanic rocks in the southern part of the area (in the region of the geothermal field), whereas volcanic sediments (water-laid tuffs, breccias, tuffaceous shales, and sandstones) show a proportionate increase to the north. Wells B21-1, B21-2, and B23-1 cut a section of the Chloropagus Formation composed almost entirely of volcanic rocks. The interbedded tuffs and other sediments reappear to the north and south, in both stratigraphic tests and outcrops. This variation is compatible with a pre-existent high in the region of the geothermal anomaly which affected depositional patterns during Chloropagus time.

## DESERT PEAK FORMATION

The Desert Peak Formation was named by Axelrod (1956, p. 97) for exposures in the central part of the Hot Springs Mountains. The Desert Peak Formation crops out north and west of Desert Peak and on the northwest flank of the Hot Springs Mountains, where it overlies the Chloropagus Formation and is in turn overlain by the Truckee Formation (pl. 13).

The lower member of the Desert Peak Formation consists of interbedded siliceous shale, basaltic tuff, and dense, olive-gray basalt flows. The lower member was apparently deposited only locally, because it thins and is absent in outcrops on the margins of the Hot Springs Mountains.

The upper member of the Desert Peak Formation consists of thinly bedded diatomite, thin silicified shales, and minor amounts of basaltic tuff. The upper member is distinguished by its consistent thin bedding,

white to cream coloration, and a distinctive weathering style referred to by Axelrod (1956) as "poker chip" weathering.

The Desert Peak Formation is about 900 feet thick and lies with apparent conformity on the Chloropagus Formation, although the lower member apparently was deposited in more restricted waters than was the upper member. The lower member pinches out to the north, south, and east within the northern Hot Springs Mountains, where the upper member laps onto the Chloropagus Formation. The formation is either absent or not recognizable in cuttings from wells in the geothermal field itself, although remnants of the formation are visible in outcrops around the field. Fossils have not been recovered from the Desert Peak Formation, but its age is assumed to be early Pliocene on the basis of its stratigraphic position between the Mio-Pliocene Chloropagus and middle Pliocene Truckee Formations.

### TRUCKEE FORMATION

The Truckee Formation is composed of fluvial and lacustrine sediments and associated volcanic rocks. It is well exposed on the northern and western margins of the Hot Springs Mountains but is absent in the interior portions due to erosion. Axelrod (1956) divided the formation into three members. The lower member consists of basaltic tuff; palagonite tuff; gray, mollusc-rich, sandy coquina; limestone; water-laid ash; tuff breccia; sandstone; diatomaceous shale; and basalt. The middle member is predominantly thin-bedded to massive white diatomite with lesser amounts of light gray vitric ash. The upper member consists mostly of slabby limestone with interbedded gray sandstone, very thin diatomite beds, and basalt-pebble conglomerate.

The lower contact of the Truckee Formation is gradational into upper Desert Peak siltstones and tuffs over a vertical distance of 20 feet. According to Axelrod the lower member of the Truckee pinches out to the northwest. All three members appear to thin to the southeast, and it is reasonable to assume that the basin in which the type Truckee accumulated was of limited extent and may have been only 10 to 15 miles in diameter. The top of the Truckee Formation was not observed in the area. The age of the Truckee Formation is almost certainly Pliocene. Fossils found by Axelrod and other workers indicate that the formation ranges from late Clarendonian (early Pliocene) to Hemphillian (middle Pliocene) and that portions may be as young as Blancan (late Pliocene).

### YOUNGER VOLCANIC ROCKS

A series of olivine basalts unconformably overlie the Truckee and Desert Peak Formations in the western portion of the northern Hot Springs Mountains. Rocks of this unit occur mostly in the western part as erosional remnants capping small ridges and mesas. The basalts are rare east of the Telephone Road (informal name, pl. 13). Since the lower contact is unconformable with the middle Pliocene Truckee Formation, the basalt sequence may be as old as late Pliocene. An upper age limit is harder to ascertain. Within the area mapped, the

basalts were extensively faulted and eroded prior to Lake Lahontan sedimentation. Also, field relationships imply that the basalts are older than the andesite ash-flow sequence described below, tentatively establishing the age of the basalts as wholly Pliocene.

### ANDESITE ASH-FLOW TUFFS

A sequence of andesitic ash-flow tuffs occurs mostly southeast of the Telephone Road in the northern part of the Hot Springs Mountains. The little-studied sequence consists principally of plagioclase-hornblende ash-flow tuffs which lie with angular unconformity on sedimentary rocks interpreted as the Truckee, Desert Peak, and Chloropagus Formations. Folding and faulting preceded and in part controlled deposition of the andesite unit. In general the thickest andesite accumulations occur in the troughs of synclines and along scarps created by downdropped blocks prior to eruption of the andesitic tuffs (fig. 34). The extent of erosion is unknown but it appears that the unlithified top portion of at least one cooling unit has been removed, creating a stripped structural surface (E. C. Bingler, personal commun., 1978). The original thickness is therefore unknown, although geologists of the Southern Pacific Company measured about 500 feet of section east of the mapped area.

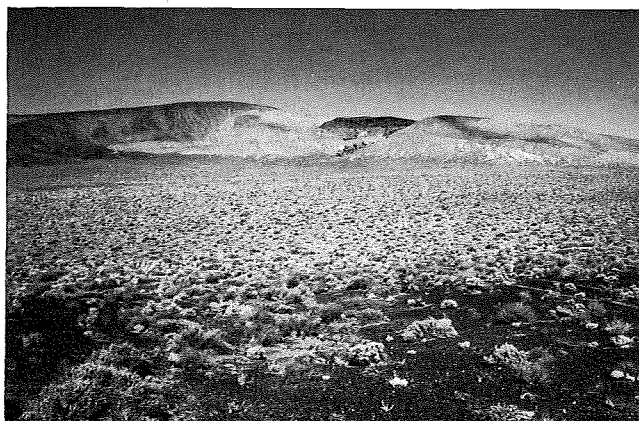

FIGURE 34. Photograph of the andesite ash-flow tuffs lying in synclinal troughs in the Truckee Formation, NE/4 S27,T22N,R26E. The photo shows the westernmost occurrence of the ash flow in a synclinal trough composed of limestone. The ash-flow tuff appears as a small brown cliff.

Three discordant radiometric K-Ar age determinations have been obtained from mineral separates in the andesite sequence. A private laboratory dated plagioclase at 11.2 m.y.; the USGS dated hornblende at 4.6 m.y. and plagioclase at 2.3 m.y. (N. Voegtly, personal commun., 1978). The discordance of the radiometric determinations raises a potentially severe problem. If the sedimentary rocks beneath the andesite unit are correctly correlated with the Truckee, Desert Peak, and Chloropagus Formations, and if the 11.2 m.y. date is correct, then the age index for Nevada's Tertiary nonmarine fossil record needs revision. However, a 2.3 to 4.6 m.y. age for the andesite sequence



is compatible with the correlations and fossil evidence. The latter interpretation is considered to be correct; if so, the andesite may be the youngest ash flow in Nevada. This sequence needs further radiometric evaluation.

### DESERT QUEEN INTRUSIVE

A small pluton of hornblende-quartz diorite crops out in the vicinity of the Desert Queen Mine (pl. 13). In hand specimen, the rock is mildly propylitized and dull gray-green on both fresh and weathered surfaces. It is fine grained, holocrystalline, and equigranular, consisting of sodic plagioclase, hornblende, quartz, and minor potash feldspar. The intrusive is bounded on the east by a normal fault. The north boundary is obviously intrusive into slightly older or nearly coeval volcanic rocks of the unnamed rhyolite unit. The west and south boundaries are inferred to be intrusive into the rhyolite unit and the Chloropagus Formation.

Willden and Speed (1974) assigned a Jurassic age to the diorite. However, field relationships suggest that the intrusive may be as young as Miocene or early Pliocene. Volcanic tuffs and flows along the north margin have been intensely metamorphosed by the intrusion of the diorite, both thermally and dynamically. These volcanic rocks are lithologically more similar to Tertiary volcanic units than any of the Mesozoic rocks exposed in the surrounding region, and they are probably metamorphosed equivalents of Tertiary rhyolitic tuffs in the unnamed rhyolite unit. Andesites of the lower Chloropagus Formation on the west margin have been propylitized, and dacitic and rhyodacitic rocks of the unnamed rhyolite unit on the south margin have been similarly altered. Presumably the alteration was caused by emplacement of the pluton. Other Tertiary intrusives, some of quartz diorite composition, have been mapped in neighboring areas by Johnson (1977), Bonham (1969), and Thompson (1956). For example, Bonham mapped a compositionally similar intrusive in the Olinghouse district (20 miles to the west) which intrudes the Hartford Hill Rhyolite and overlying Chloropagus Formation. The Davidson granodiorite near Virginia City intrudes the Miocene Alta Formation, which is at least partially a temporal equivalent of the Chloropagus Formation (Bonham, 1969). Unfortunately, no radiometric dates have been obtained from these Tertiary intrusions, and due to the pervasive alteration it is doubtful that a reliable radiometric date could be obtained from the Desert Queen pluton. However, evidence such as that cited above suggests a late Miocene or earliest Pliocene age of intrusion.

### QUATERNARY ALLUVIUM

Quaternary deposits are a general map unit which include Lake Lahontan sediments, alluvial fan deposits, sediment gravels, playa deposits, wind-blown sands, and minor amounts of siliceous sinter around Brady's Hot Springs. These deposits are significant only because they obscure the geology in the vicinity of the Desert Peak geothermal anomaly, as well as any evidence of geothermal activity.

## STRUCTURE

The northern Hot Springs Mountains are dominated by a north-northeasterly trending structural pattern. The formations strike north-northeasterly, and the folds and faults generally are parallel to them. This dominant north-northeast structural trend is disturbed in the vicinity of the geothermal field by a northeast-trending zone of disruption where the rocks have been structurally elevated (fig. 35). In general, the older rocks exposed in the central regions are flanked by increasingly younger formations to the east and west.

The formations in the area around the geothermal anomaly are folded. These folds trend north-northeast and usually plunge gently to the south. Most of the folding is gentle but asymmetrical, and it is best preserved in surface exposures of lacustrine sediments of the Truckee and Desert Peak Formations, but involvement of thick volcanic sequences of the Chloropagus Formation in the cores of the folds implies a deep-seated origin, rather than simple slumping or décollement-style tectonics. Although the folds could be the expression of fault-related compressive forces, their consistent orientation and configuration suggest they may instead be the consequence of differential block movement on basement faults (Stearns, 1971). If so, basement faults proximal to the folds, which do not appear at the surface, would be required. Field relationships and well data suggest that numerous faults are present in the deeper Tertiary volcanic units which do not dislocate the overlying sedimentary rocks. Unfortunately, delineation of the entire fold pattern is severely hampered by discontinuous exposures of folded rocks. Later intense faulting disrupted and undoubtedly obscured or obliterated many earlier formed folds. Many fold-disruptive faults now seen at the surface were probably initially basement block faults which contributed to fold origination. Initial faulting in basement rocks was absorbed in the overlying sediments by drape folding. Later movement on the faults was sufficiently large to break the sedimentary section as well. Folding is probably late Pliocene to early Pleistocene in age.

Two distinct fault sets are present in the northern part of the Hot Springs Mountains. The dominant fault pattern trends about N25°E and appears to be related to basin-and-range tectonic stresses. A subordinate and less well defined fault pattern trends about N55°E to N70°E. Other faults of variable orientation and local nature also occur in the area. A few of these trend N10°W to N40°W, subparallel to the Walker Lane. Fault displacements are difficult to ascertain, owing to a lack of readily identifiable marker beds and discontinuous outcrops, but they apparently range from approximately 50 to as much as 1000 feet.

Several N25°E-trending faults localize geothermal heat. The most obvious of these is Brady's Thermal Fault, which traverses S1,12,13,T22N,R26E. The trace of this fault is revealed by hot springs, fumaroles, sinter deposits, hydrothermal alteration, and discontinuous fault-scarp features (Brogan and Birkhahn, 1980).

Approximately ¼ mile west of Desert Peak and extending N30°E to S30°W, the apparently high-angle

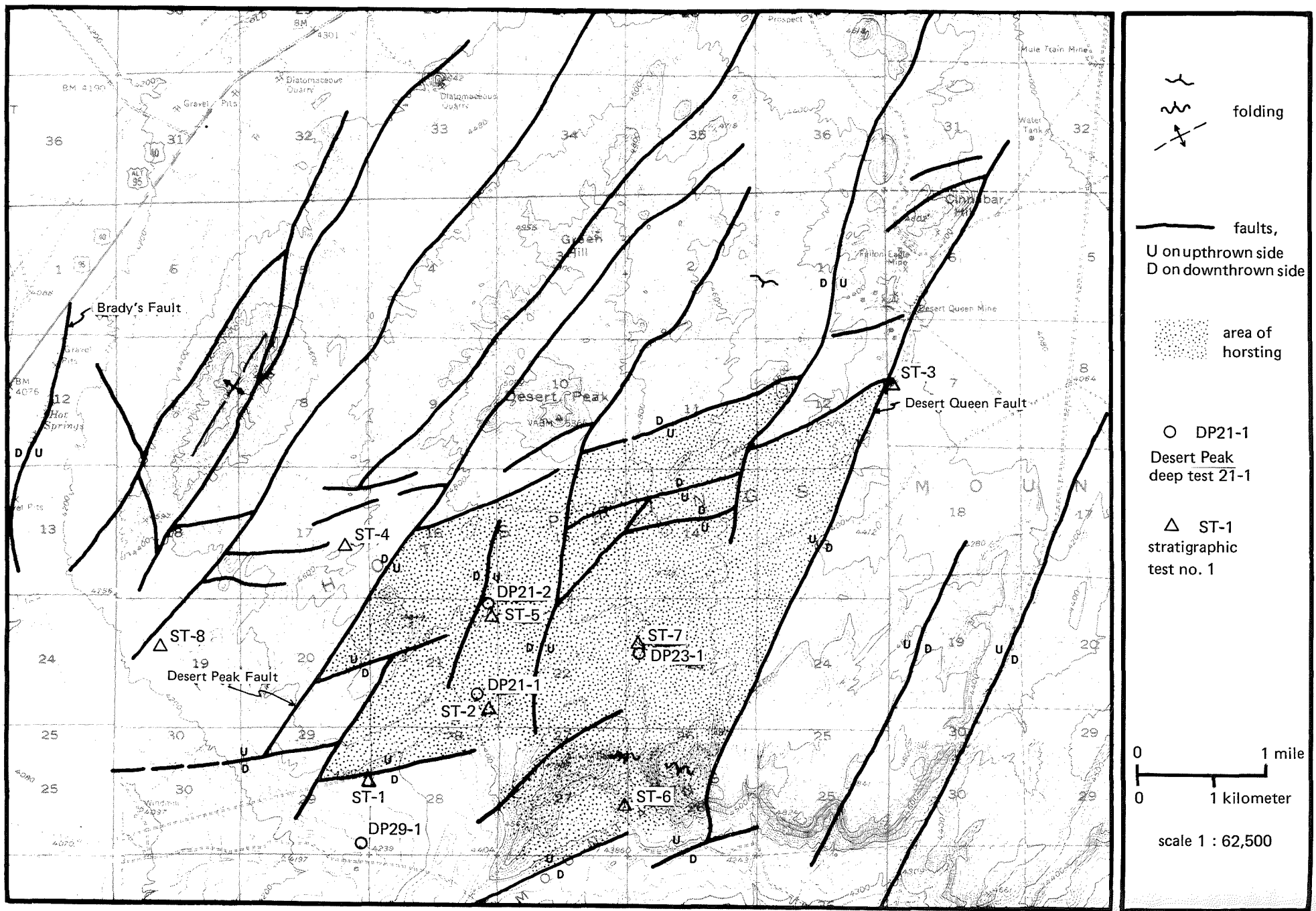

FIGURE 35. Simplified structure map of the Desert Peak area.

Desert Peak Fault (fig. 35) drops lower Desert Peak Formation on the west against upper Chloropagus Formation volcanics on the east. Displacement on this fault may be as much as 1000 feet, based on geologic data from strat. test no. 4. This fault is significant in that it may be part of the boundary system for the Desert Peak geothermal field. Although the age of this fault is uncertain, it probably postdates the younger volcanic unit.

The Desert Queen Fault (informal name, fig. 35) trends about N25°E, dips 50°E east (where measured), and drops andesite ash flows on the east against lower Truckee Formation limestone on the west. The total displacement at the southern portion of the fault is roughly 100 feet, but displacement increases northward to the vicinity of the Desert Queen Mine, where andesite ash flows on the east are dropped against the unnamed rhyolite unit. Erosion prior to faulting in addition to faulting prior to deposition of the andesite account for some apparent displacement, but the dip-slip is still at least 500 feet. The increase in displacement northward along the fault is supported by detailed gravity work discussed later, which shows a gradual but definite increase in gravity relief northward along the trace of the fault. Because the Desert Queen Fault cuts the andesite sequence, the latest movement must be younger than 2.3 to 4.6 m.y.

Other faults in the southeast portion of the mapped area have displaced the Truckee Formation and older rocks more than the overlying andesite ash flows. The andesite sequence characteristically has been stepped down to the east, usually in increments of 50 to 100 feet. The underlying Truckee, Desert Peak, and Chloropagus Formations have been displaced in a similar sense, but the dip-slip ranges from 100 to 500 feet. Clearly, faulting was initiated prior to deposition of the andesite sequence. Continued similar stress during and after andesite deposition was accommodated along essentially the same fault planes.

The distribution of rocks in the northern Hot Springs Mountains suggests that the area is a highly faulted and tilted fault block which trends north-northeast. Older rocks of the unnamed rhyolite unit are exposed in the central portion of the area and in the vicinity of the geothermal anomaly, and increasingly younger rocks are exposed outward, both to the east and west (pl. 13; Willden and Speed, 1974). Differential movement of blocks has left the area between the Desert Peak Fault (informal name) and the Desert Queen Fault structurally elevated relative to surrounding areas. Blocks are incrementally stepped down to the west and to the east west and to the east (fig. 36).

The second and subordinate fault set occurs as a vaguely defined zone which is first seen in S29, T22N, R27E, trending approximately N60°E to the vicinity of the Desert Queen Mine. Faults within this zone trend from N50°E to N76°E. Most fault traces can be followed or inferred for only short distances, usually about 1 mile, and they appear to predate the basin-and-range faults, although the apparent termination of a few of the basin-and-range faults by N60°E faults implies renewed or concurrent movement on N60°E faults. Unfortunately, traces of the N60°E faults are mostly con-

cealed beneath alluvium, and the actual relationship between N25°E and N60°E fault sets is inferential at best. Slickensides observed at the north end of Rhyolite Ridge (informal name, pl. 13) rake 52°SE, indicating that at least the last motion of the N60°E faults had an oblique component. Thus it appears that some amount of horizontal shear contributed to the formation of the zone.

Surface evidence suggests that the area in the N60°E zone is a horst. Faults at the southeastern edge of the zone have moved down on the south, whereas faults along the northwestern margin of the zone have moved down to the north. Well relationships suggest that central portions of the horst (S14, 15, 21, 22, T22N, R27E) may be structurally elevated over the surrounding terrain by as much as 2000 feet, although movement on each individual fault is probably only 200 to 500 feet. For example, the base of the Chloropagus Formation in well 29-1 is nearly 1500 feet lower than the formation base in well B21-1 and approximately 2700 feet lower than in well B21-2, although some of the apparent structural high is undoubtedly the result of differential erosion, dipping rock sequences, and later movement along N25°E-trending faults. Nevertheless, the N60°E zone crudely defines a horst system within the zone boundaries.

The area within the N60°E-trending fault zone was apparently elevated during the latter stages of deposition of the unnamed rhyolitic unit, as indicated by sporadic occurrences of gravels in the upper part of the rhyolite section in the wells. Additional support for the elevated nature of this area includes a decrease in thickness of the overlying Chloropagus Formation and a local, uncharacteristic lack of sedimentary intercalations which are prevalent in the Chloropagus Formation elsewhere in the area. This suggests that uplift along N60°E-trending faults occurred in late Miocene time. A second uplift occurred later, probably in late Pliocene, along N25°E-trending faults, principally the Desert Queen and Desert Peak Faults. A late Pliocene age is implied by the unconformable relationship of the andesite ash-flow sequence with the underlying rocks, which were folded, faulted, and eroded prior to andesite deposition.

The result of these two distinct faulting episodes is the creation of an en echelon, rhombohedral series of horst blocks defined by the N25°E and N60°E faults (fig. 37). The en echelon horsts occupy the area from S29, T22N, R27E to Cinnabar Hill, S6, T22N, R28E. The east and west boundaries of the horst complex appear to be the Desert Queen and Desert Peak Faults. The north and south boundaries are the outlying faults of the N60°E fault zone.

## GRAVITY

Phillips Petroleum Company ran a reconnaissance gravity survey in 1974 over the western part of the Carson Sink. The gravity stations were unsurveyed and generally were greater than 1 mile apart. The results of this survey indicate that two main structural trends are north-northeast and a less obvious northwest grain. The

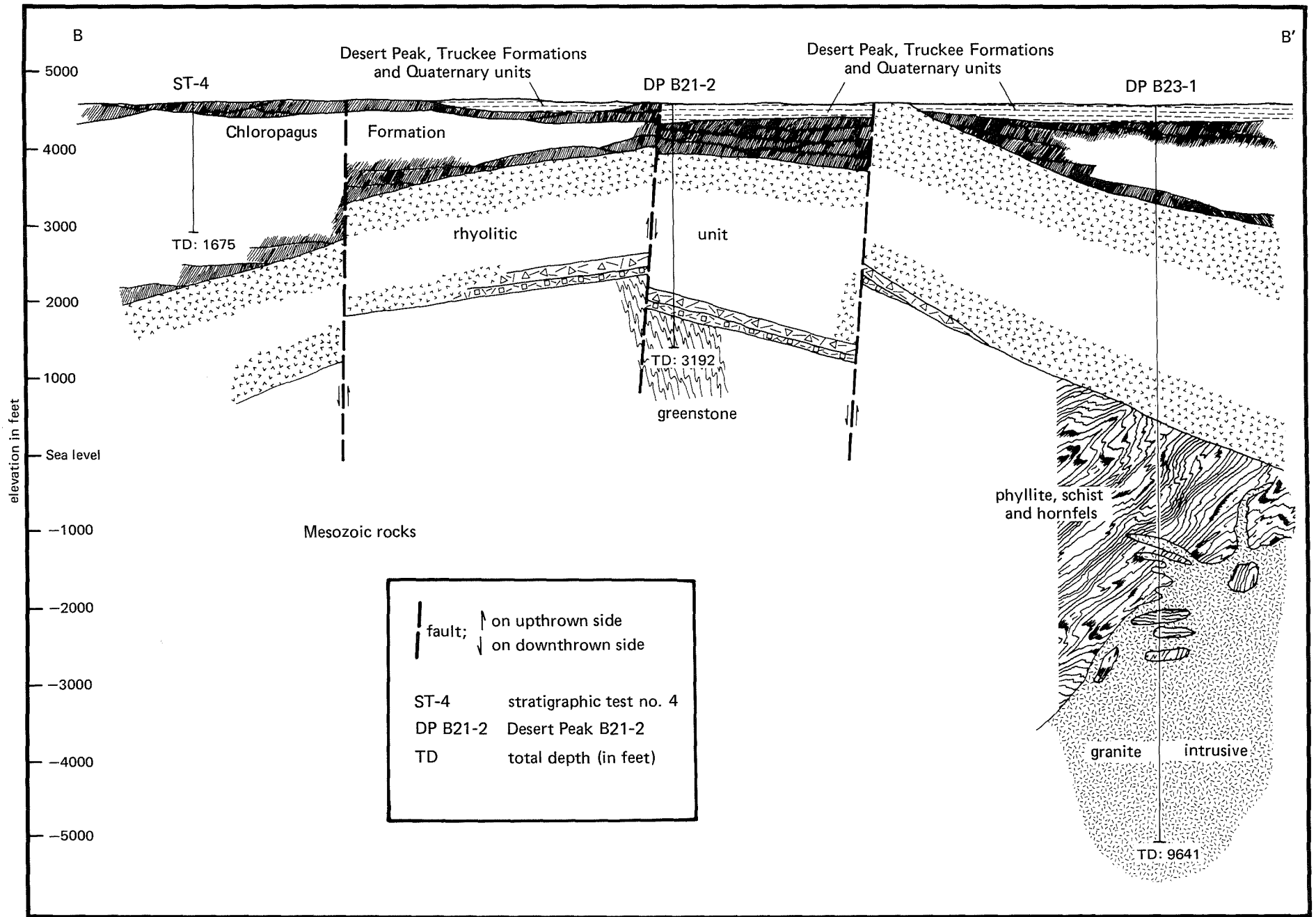
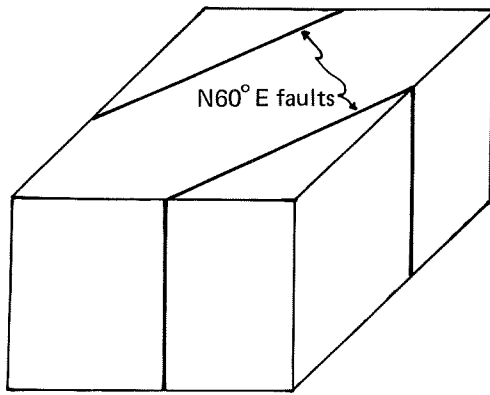
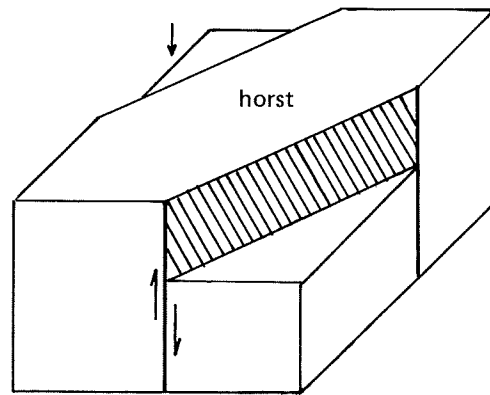

FIGURE 36. Geologic cross section B-B' (see plate 13 for location of B-B').



a

block showing initial  $N60^\circ E$  fractures



b

showing horst formed along  $N60^\circ E$  faults

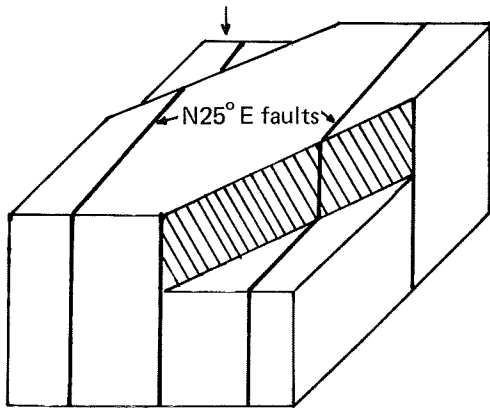

c

block showing  $N25^\circ E$  fractures on horsted block

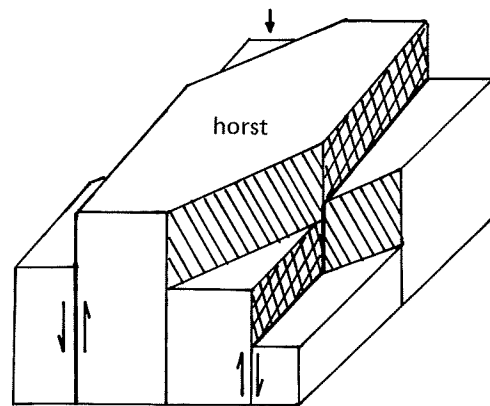

d

showing rhombohedral horst block bordered by  $N60^\circ E$  and  $N25^\circ E$  faults

**FIGURE 37. Block diagram depicting formation of rhombohedral horst blocks.**

survey did not reveal any other anomalous gravity features in the vicinity of the geothermal anomaly, and more detailed gravity information was not needed at that time.

After the discovery well (B21-1) and confirmation well (B21-2) were drilled and the geologic map was completed, a tentative model of a fault-bounded reservoir was proposed. The large displacement faults shown on the geologic map (pl. 13), coupled with the significant density contrasts between different lithologic units (table 8), could allow a detailed gravity survey to locate possible reservoir boundaries. Accordingly, a 113-station gravity survey covering about 15 square miles was completed in January 1979 by an independent contractor (Dallon, 1979). There are about eight stations per square mile, and where possible the stations were located on relatively level ground rather than adhering to a strict grid system. This eliminated Hammer terrain-corrections rings B, C, and D from the topographic corrections.

A LaCosta-Romberg model G gravity meter (no. 295) was used; readings were recorded to the nearest hundredth of a milligal. All stations were surveyed with a Beetle 1600 distance meter and a Leitz T60D theodolite. The vertical elevations were obtained to the nearest foot and the horizontal control is within 5 feet. The total error in the gravity determinations due to errors in vertical elevations and horizontal control should be less than 0.1 milligal. A gravity base loop was established and all readings were taken in loops of three hours or less duration. Each loop was tied to the nearest gravity station along the base loop. A correction of 0.0635 milligals per vertical foot was added for calculation of the simple Bouguer anomaly. This value is based on the average density of 2.383 g/cm<sup>3</sup> as determined by density logs from well 29-1. The elevation datum used is 4000 feet above mean sea level. Terrain corrections for Hammer terrain-correction rings E to J were performed manually, and a latitude correction of 1.288 milligals per mile southward was added to calculate the complete Bouguer gravity.

The complete Bouguer gravity map is shown on plate 14. The contour pattern is complex and is characterized by several small anomalies which have up to 2 or 3 milligals of relief over a horizontal distance of ¼ to ½ mile. Habiger (1979) modeled the gravity data and con-

cluded that these small anomalies result from features above a depth of 2000 feet. Because the Tertiary volcanic sequence is present to depths greater than 2000 feet everywhere except the extreme northeastern corner of the gravity map, these small anomalies probably result from structural or lithological variations within the volcanic section.

The total gravity relief on the map is 9.4 milligals. In the southwest corner of the map the lowest value is 86.2 milligals, and the highest value of 95.6 milligals occurs in the northeast corner. There is an irregular but steady increase in gravity from southwest to northeast (pl. 14). Geologic and drill-hole information suggest that pre-Tertiary and intrusive rocks are present at shallower depths to the northeast. However, a plot of the known depths to the top of the pre-Tertiary rocks shows that the gravity map does not accurately predict the depth to pre-Tertiary rocks (pl. 14). This is partially due to complications first noted after well B23-1 was drilled. The pre-Tertiary rocks in well B23-1 are not as dense as the pre-Tertiary rocks in the other wells (table 8). Reliable compensation for this density contrast is not possible with presently available deep well data.

The gravity contour pattern which outlines the small anomalies also indicates that three main structural trends are present in the area: 1) north to north-northeast; 2) northeast to east-northeast; and 3) north-west. Plate 14, which shows these gravity trends, was constructed by drawing lineaments based on gravity contours alone. Mapped faults were added later. No single gravity trend dominates the gravity map as the north-northeast fault trend dominates the geologic map. However, the gravity survey was run over a part of the Hot Springs Mountains, which is covered mostly with sand. Outcrops are sparse and few faults were mapped in the area. Therefore, it is possible that no single fault trend predominates in the area covered by the detailed gravity study, even though the fault density there may be similar to that elsewhere in the Hot Springs Mountains.

Several north- to north-northeast-trending lineaments are shown on plate 14. These lineaments are generally parallel to mapped faults but rarely overlie them, with the exception of the Desert Queen Fault, which shows up well both on the ground and on the gravity map. Habiger (1979) reports that the Desert Queen Fault is

TABLE 8. Average densities from downhole geophysical logs and cores.

Lithologic unit	Average density from neutron-formation density logs			Dry bulk density
	Well 29-1	Well 21-2	Well B23-1	
Chloropagus vesicular basalts and andesites	2.25 g/cm <sup>3</sup>	---	---	---
Unnamed rhyolitic unit	2.45 g/cm <sup>3</sup>	2.55 g/cm <sup>3</sup>	---	---
Pre-Tertiary metamorphic rocks	2.65 g/cm <sup>3</sup>	2.65-2.70 g/cm <sup>3</sup>	2.2-2.55 g/cm <sup>3</sup>	---
Hornblendite intrusive	2.75 g/cm <sup>3</sup>	---	---	---
Well B21-2 greenstone core	---	---	---	2.75 g/cm <sup>3</sup>
Granite	---	---	2.55 g/cm <sup>3</sup>	---
Granite fragment from well B23-1	---	---	---	2.56 g/cm <sup>3</sup>

one of only two major structures detectable on the gravity map. Interestingly, the Desert Peak Fault has no expression on the gravity map, which is somewhat disturbing, since geologic evidence suggests that it may have up to 1000 feet of displacement and may be a part of the reservoir boundary system.

Several gravity lineaments which parallel the east-northeast fault set mentioned in the geology section are shown on plate 14. In fact, the longest lineament on the gravity map has this trend. However, the low gravity relief of about 2 milligals across the lineaments suggest that vertical displacement on individual faults is small.

The third trend of northwest-trending gravity lineaments has no expression in surface geology. These lineaments roughly parallel the Walker Lane (fig. 2), but the relationship between the two, if any, is conjectural. The second major structure reported by Habiger (1979) has this trend and cuts across the southwest corner of the gravity map. Although there is little geologic evidence to suggest that this lineament is a fault, thermal data shown on figure 20 and plate 12 do corroborate a fault explanation for this structure.

The most striking anomaly on the gravity map is a 2-to 3-milligal high centered in the S/2 S15, T22N, R27E. The north-south axis of this anomaly correlates well with a portion of a fault (or faults) which uplifted and exposed the unnamed rhyolitic unit (pl. 13; fig. 36). The amount of apparent separation on this fault suggests that it may be a significant feature, but it is expressed over only limited distance on the gravity map. The shape of the anomaly is more complex than would be produced by a single normal fault. Additional faulting, substantial lithologic variations, or secondary alteration or mineralization in the Tertiary volcanic rocks could all contribute to or be responsible for the formation of this anomaly.

The complete Bouguer gravity map apparently shows the effects of near-surface variations in the Tertiary volcanic pile; these variations are superimposed on a regional trend which is believed to be a result of the northeasterly rise toward the surface of basement rocks (pre-Tertiary or intrusive). Contour trends on the gravity map correlate well with the geologic fabric, although the individual fault to lineament correlation is spotty. Some mapped faults which are thought to be significant are not reflected on the gravity map, and one of the most striking gravity trends has no surface geological expression in the area. The gravity map has neither outlined the geothermal reservoir nor defined the reservoir boundaries. It has provided some amount of corroboration for mapped geologic trends, revealed some potentially significant trends unseen at the surface, and substantiated portions of a slightly perplexing temperature-distribution pattern. It should be noted, however, that in a volcanic terrain with complex surface and basement geology and limited subsurface geologic information, gravity data cannot be expected to provide simple solutions for complex problems.

## GEOLOGIC STRUCTURE AND THE GEOTHERMAL RESERVOIR

Post-discovery geologic mapping in the northern part of the Hot Springs Mountains shows that the area underlain by the Desert Peak geothermal field is structurally higher than other parts of the northern Hot Springs Mountains. Most of the surface in this area is covered by alluvium, but where bedrock is exposed it consists mostly of rocks of the lower Chloropagus Formation or of units of the unnamed rhyolite sequence. The subsurface temperature distribution is areally non-linear; based on present hole spacing, it does not indicate an obvious association with faults observed at the surface. In fact, the lack of this association strongly suggests that some mechanism other than high-angle faulting serves to localize the heat.

Defining and locating the geothermal reservoir boundaries poses critical problems in the study of the geothermal reservoir. Solutions to the problem at Desert Peak are complicated since the rocks in which the reservoir occurs are not exposed nearby. Where similar pre-Tertiary rocks crop out in neighboring ranges they are highly deformed. Lithology appears to exert some influence on the reservoir configuration, but structural controls obviously exist but remain almost totally unidentified. It is possible that geologic structure observed at the surface at Desert Peak has no relationship to reservoir boundaries. However, it will eventually be necessary to choose possible reservoir boundaries based on geology, if only as a first approximation, in order to facilitate planning and future work. Possible geologic boundaries have been selected (fig. 38), but these are subject to change as additional subsurface information becomes available. Possible reservoir boundaries based on temperature and gravity data were discussed previously in the section of this report on the Desert Peak reservoir. The proposed geologic boundaries were chosen to conform with the temperature data insofar as possible.

The most credible boundary at present is the southwest boundary. This boundary is defined by both gravity (pl. 14) and temperature data (fig. 20; pl. 12). The exact location and limits of this boundary are uncertain. It may be an unexposed fault or fault zone.

A possible candidate for the northwestern boundary is the Desert Peak Fault (fig. 34; pl. 13). The significance of this fault to the geothermal reservoir is questionable; however, the fault is part of a major topographic lineament in the Hot Springs Mountains. The southeastern boundary of the field could be the Desert Queen Fault. The gravity contours confirm the presence of this fault, and it is the first substantial known structure east of well B23-1. A northern reservoir boundary is even more speculative at present. Possibly the northern margin of the N60°E-trending fault system also acts as a field boundary (fig. 35; pl. 13).

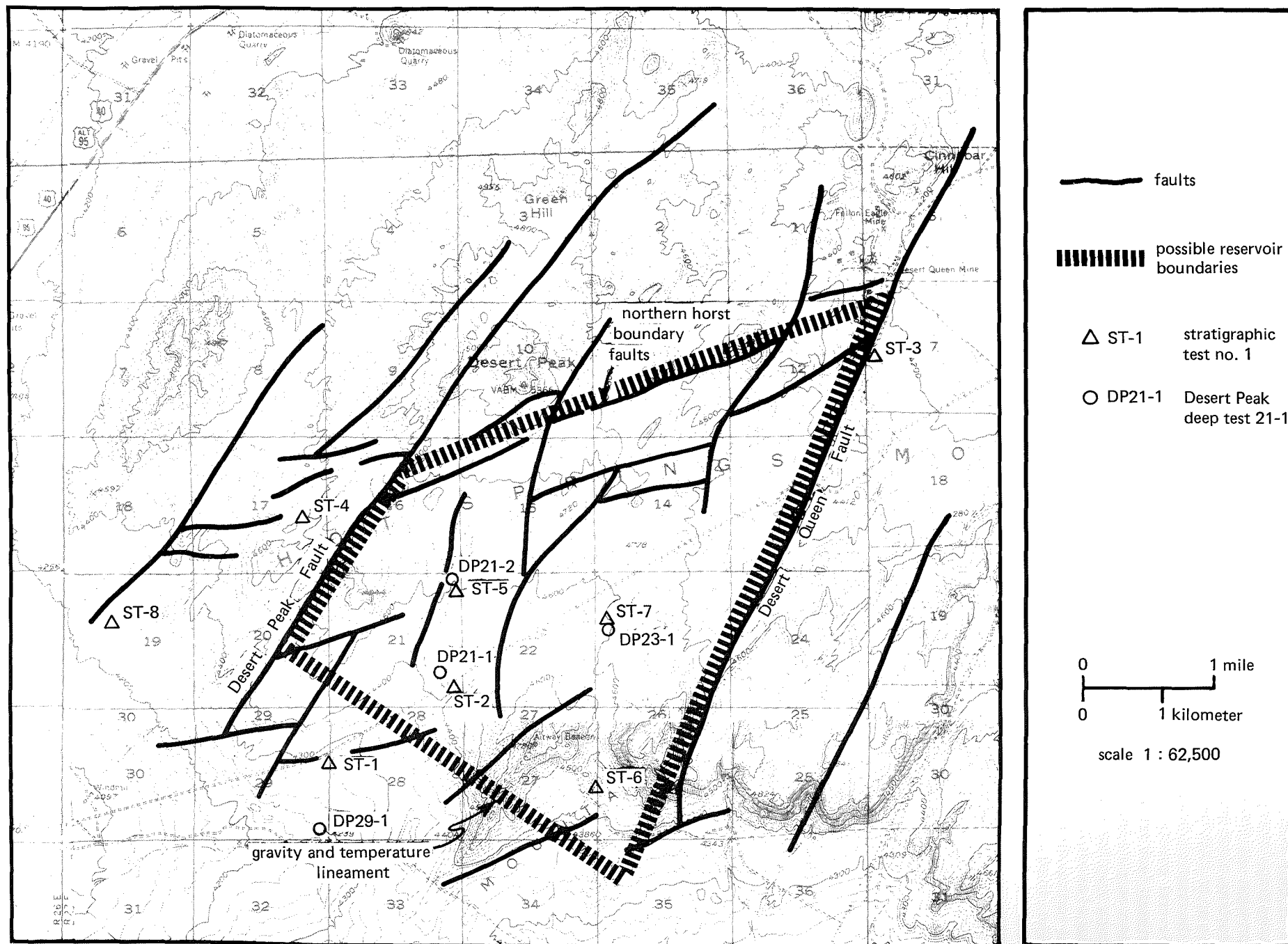

FIGURE 38. Map showing possible reservoir boundaries.



Field mapping, temperature data, and detailed gravity work suggest that the Desert Peak geothermal field is contained in the en echelon rhombohedral horst system described earlier. Two apparent stages of uplift along two distinct fault sets have resulted in an area of structural elevation at the intersection of the two structural trends. Structural elevation in this area is significant to the geothermal anomaly in at least two ways: 1) the thermal aureole surrounding the geothermal reservoir was brought up to depths shallow enough to be detected by shallow drill-hole exploration methods, and 2) Mesozoic rocks which contain the reservoir are nearer the surface and within range of economic exploitation. If the reservoir were too deep, the Desert Peak discovery would have been an exploration success but an almost certain economic failure.

Although the proposed geologic boundaries agree with the approximate areal limits of the deep thermal anomaly, they do not constitute the geothermal reservoir, as is the case with Brady's Fault. Tertiary high-angle faults probably act only as reservoir boundaries, although at least one Tertiary fault taps the geothermal reservoir. This fault functions as the conduit for thermal water which leaks from the reservoir into the Southwest Aquifer system (previously described). Other than this leakage, the Tertiary faults in the Desert Peak area apparently do not transmit large amounts of thermal fluids.

The geothermal reservoir waters are contained in fractures in pre-Tertiary rocks. Tertiary volcanic rocks form a somewhat leaky but generally effective cap over the reservoir. The Tertiary rocks are not appreciably hydrothermally altered, indicating that thermal water circulation in the younger rocks has been minor, in spite of pervasive Tertiary high-angle faulting. Productive fractures are apparently confined to pre-Tertiary rocks whose stratigraphy and structure are not well known. Correlation of pre-Tertiary units between the four deep tests is still speculative, which also hampers the interpretation of the reservoir fracture system. However, there are several implications from the available evidence.

One implication is that Tertiary fault zones might intersect pre-existent Mesozoic fracture systems. Tertiary structural intersections (such as the north-northeast and east-northeast trends at Desert Peak) superimposed on Mesozoic structures could well provide sufficient porosity and permeability for deep, high-volume circulation of thermal waters, as well as a basis for localization. It is not known why some Tertiary faults act as borders whereas others remain permeable.

The Humboldt Lopolith (Speed, 1976) contains bedding repetitions, comagmatic greenstones, and intrusion-related thrusting in the nearby West Humboldt Range and Mopung Hills. This relationship, along with the presence of hornblende in well 29-1, has led to consideration of the possible involvement (lithologically and structurally) of the lopolith in the localization of the geothermal reservoir, but this is highly conjectural.

It has also been suggested that the Desert Peak geothermal field occurs in the faulted nose of a south-plunging anticline. The surface distribution of rocks is suggestive of this, as are the numerous cross sections that have been drawn. Numerous folds of possible deep-

seated nature occur both east and west of the geothermal field (pl. 13). Thermal waters could be localized by fracturing where flexure has been most severe, perhaps at the anticlinal crest. The fault block in which well B21-2 was drilled could be slightly down-dropped, in a keystone effect (fig. 36).

The source of heat is presently unknown. The available information does not support the inference of a shallow magma chamber below or tangential to the Hot Springs Mountains. Heat flow outside the Brady's and Desert Peak thermal anomalies is near average for the Basin and Range physiographic province (Olmsted and others, 1975). The thermal waters must circulate to depths greater than 10,000 feet to attain the observed temperatures (Hose and Taylor, 1974). Geologically, the relationship between Brady's Hot Springs and the Desert Peak thermal area is uncertain. Their proximity suggests a common heat source, but water chemistry and temperature distribution indicate that the two systems are not connected at shallow levels. Because the high temperatures observed imply circulation as deep as 10,000 feet or more, the systems are probably not connected at depth as well. It is suspected, therefore, that both thermal anomalies reflect deep unconnected thermal water convection systems and that their proximity is geologically coincidental. Thus, the two areas may have the heat source in common, but the thermal convection systems are separate entities.

The Desert Peak geothermal field occurs at the intersection of two structural trends. Structural elevation has brought the reservoir, contained in pre-Tertiary basement rocks, to depths shallow enough to permit detection and potential economic exploitation. High-angle Tertiary faults may serve in part as boundaries for the field. The thermal fluids are capped by a thick Tertiary volcanic sequence which functions effectively despite pervasive basin-and-range faulting; the cap allows a relatively small amount of thermal water leakage. Fractures which allow the movement of fluid within the geothermal reservoir may be a consequence of the intersection of Tertiary faults and pre-Tertiary basement tectonic elements.

## CONCLUSIONS

Geology, geophysics, and geochemistry played a minimal role in the discovery of the Desert Peak geothermal field. The commodity sought was heat, and only direct-heat detection methods proved reliable. The discovery can be attributed wholly to the shallow temperature-gradient holes, stratigraphic tests, and the temperature patterns deduced from them. Existing geologic information gave no clues as to the presence of the geothermal resource (except for Brady's Hot Springs, 4 miles to the west). Active electrical resistivity techniques, rather than delineating the reservoir, were short-circuited by the shallow thermal aquifer system and only in part corroborated the data obtained from the shallow temperature-gradient holes. Regional and detailed gravity surveys and a magnetotelluric study were employed with ambiguous results. Infrared imagery flown in 1978 revealed no surface heat anomaly and proved what was already known: the Desert Peak geothermal field is a blind discovery.

**APPENDIX 1  
TEMPERATURE-GRADIENT DRILL HOLES (IN °F)**

Hole number	1	2	3	4	5	6	7	8	9
Location	NE/4 SW/4 S11,T22N,R26E	SW/4 NW/4 S26,T23N,R26E	SE/4 SE/4 S10,T23N,R26E	SW/4 NE/4 S17,T23N,R27E	NE/4 SE/4 S29,T23N,R27E	SW/4 NW/4 S23,T23N,R27E	NE/4 SE/4 S22,T22N,R26E	SW/4 NW/4 S30,T22N,R27E	NW/4 NW/4 S34,T23N,R27E
Date	March 20, 1978	March 30, 1978	September 10, 1973	September 10, 1973	September 10, 1973	September 10, 1973	September 10, 1973	September 10, 1973	October 9, 1973
Equip. used	Enviro-Labs Inc.	Enviro-Labs Inc.	Phillips	Phillips	Phillips	Phillips	Phillips	Phillips	Phillips
Depth in feet	Temperature	Temperature	Temperature	Temperature	Temperature	Temperature	Temperature	Temperature	Temperature
10	58.5		66.8	67.8	60.2	66.9	70.4	70.7	64.2
20	58.6		62.1	67.3	60.8	62.4	68.8	67.8	62.2
30		59.5	63.8	64.9	62.2	62.8	69.9	69.2	62.5
40	59.7	59.8	64.2		63.8	63.4	71.3	71.0	63.5
50		60.2	64.8	65.2	64.9	63.7	72.6	71.9	63.7
60	61.9	60.5	65.3	66.3	66.1	64.0	73.4	72.0	64.1
70		60.8	66.0	66.5	66.7	64.4	74.0	73.8	64.5
80	64.0	61.0	66.4	66.7	67.6	64.9	74.3	74.6	65.3
90		61.3	66.6	66.9	68.7	65.3	74.7	75.2	65.7
100	66.4	61.5	66.8	67.2	69.9	65.5	75.0	75.8	65.7
110		61.7	66.9	68.0	70.7	66.2	75.2	76.2	66.5
120	71.2	61.9	67.3	68.3	71.9	66.3	75.3	76.9	67.3
130		62.2	67.8	69.0	72.6	66.7	75.3	77.7	67.2
140	74.8	62.5	68.1	69.5	74.0	66.8	75.4	78.9	67.4
150		62.8	68.5	70.2	74.6	66.9	75.5	78.8	68.0
160	78.4	63.1	69.1	70.9	75.2	67.1	75.5	81.2	68.2
170		63.4	69.6	71.8	75.8	67.3	75.5	82.4	68.9
180	80.6	63.7	70.0	72.0	76.6	68.1	75.5	83.2	69.4
190		64.0	70.2	72.5	77.2	67.9	75.3	83.9	70.0
200	82.0	64.3	70.5	73.3	79.4	68.3	75.3	85.1	70.2
210		64.6	71.0	73.8	80.0	68.9	75.5	86.0	70.7
220	83.3	64.8	71.4	74.2	80.2	69.2		86.8	71.0
230	84.2	65.1	72.0	75.0	80.4	69.5		88.1	71.2
240	85.1	65.4	72.1	75.5		69.7		88.9	71.0
250	86.3	65.7	72.5	75.8	80.3	70.1		89.8	71.8
260	87.2	66.0	72.8	77.2	82.2	70.5		90.8	72.7
270	88.0	66.4	73.1	77.8	83.0	70.8		91.9	73.0
280	89.9	66.6	73.6	78.0	83.7	71.1		92.8	73.8
290	91.0	67.0	74.0	78.0	84.0	71.6		93.9	74.0
300	92.3	67.3	74.7	78.1	84.2	71.8		94.8	
310	93.4	67.6	75.1	78.2	84.8	72.0		95.2	
320	94.4	68.0	75.5	78.2	85.6	72.1		96.4	
330	95.7	68.3	75.8	78.4	85.8	72.1		97.9	
340	96.8	68.5	75.9	78.7	86.5	72.6		98.6	
350	98.0	68.9	77.2	79.0	87.1	73.0			
360	99.0	69.3	77.6	79.2	88.0	73.2		100.7	
370	100.0	69.6	77.7	79.6	88.1	73.7		101.6	
380	101.0	70.0	78.0	79.9	89.0	73.8		102.1	
390	101.7	70.3	78.8	80.1	89.2			102.7	
400	101.7	70.6	79.2	80.9	89.8			104.0	
410	100.9	70.9	79.6	81.0	90.2				
417	100.2								
420		71.1	80.1		90.9			105.2	
430		71.6	81.0		91.2			106.6	
440		72.0	81.6		91.9			107.5	
450		72.2	81.7		92.5			108.6	
460		72.7	82.1		93.0			109.7	
470		73.0	82.3		93.7			111.0	
480		73.4	82.8		94.0			111.7	
490		73.8	83.2		94.5			113.0	
500			83.2		94.6			113.6	

Hole number	10	11	12	13	14	15	16	17	18
Location	SW/4 NE/4 S35,T22N,R26E	NW/4 NW/4 S33,T22N,R27E	SE/4 SW/4 S35,T22N,R27E	NE/4 SE/4 S33,T22N,R27E	NE/4 SW/4 S31,T22N,R27E	SW/4 NE/4 S22,T22N,R27E	NW/4 SW/4 S13,T22N,R27E	SW/4 SW/4 S20,T22N,R27E	NW/4 SE/4 S4,T21N,R27E
Date	March 30, 1978	October 11, 1973	October 30, 1973	January 28, 1974	November 12, 1973	November 12, 1973	May 19, 1977	November 19, 1973	November 19, 1973
Equip. used	Enviro-Labs Inc.	Phillips	Phillips	Phillips	Phillips	Phillips	Enviro-Labs Inc.	Phillips	Phillips
Depth in feet	Temperature	Temperature	Temperature	Temperature	Temperature	Temperature	Temperature	Temperature	Temperature
10	59.2	76.0	63.5	63.7	66.0	70.8		75.3	64.1
20	59.5	83.0	61.2	70.5	63.2	71.2	64.9	82.4	64.8
30	60.0	91.8	63.0	72.2	62.4	73.5		88.7	66.7
40	60.3	98.0	64.8	76.0	62.7	75.7	67.1	96.2	69.0
50	60.6	103.8	66.4	79.6	63.0	77.3		103.5	71.3
60	60.9	110.0	67.6	83.3	63.2	80.6	70.0	111.1	73.8
70	61.2	115.2	69.2	87.8	63.3	82.8		119.5	75.6
80	61.4	121.3	70.8	92.0	63.4	84.6	72.9	126.0	77.5
90	61.7	126.0	72.3	95.2	63.5	86.3		131.8	79.5
100	62.1	131.2	74.0	98.8	63.8	88.8	75.4	139.7	82.0
110	62.5	136.0	75.4	104.5	63.9	90.4		145.5	83.8
120	63.0	141.0	76.2	108.9	64.0	92.0	77.7	152.5	85.6
130	63.5	145.5	77.5	114.4	64.2	93.8		157.0	87.4
140	63.9	150.2	79.0	119.7	64.3	95.4	79.9	165.0	89.2
150	64.6	155.1	80.7	123.4	64.5	97.0		172.0	91.2
160	65.0	160.7	82.0	123.2	64.7	98.9	82.0	177.0	93.2
170	65.7	168.0	83.4	127.5	64.9	100.7		181.0	94.8
180	66.3	173.0	84.6	127.5	65.0	102.4	84.2	184.0	96.5
190	66.9	177.0	85.8	127.5	65.2	104.8		185.5	98.5
200	67.8	181.0	87.2	161.0	65.4	106.5	86.2	191.0	100.7
210	68.6	185.0	88.5	173.2	65.8	108.0			102.5
220	69.3	192.7	89.7	185.0	66.0		88.3		104.7
230	69.8	199.0	91.0	190.5	66.1				105.7
240	70.2	205.0	92.3	193.5	66.2		90.1		108.0
250	70.7	208.5	93.2	195.5	66.3				110.0
260	71.1	213.0	94.2	199.5	66.7				111.7
270	71.6	216.5	94.9	203.5					114.3
280	72.0	219.0	96.2	206.5					116.0
290	72.3	221.5	97.5						117.8
295	72.5								
300		223.0	98.7						119.0
310		224.5	99.8						120.5
320		226.6	101.2						122.0
330		228.0	102.6						123.0
340		230.0	103.0						124.7
350		231.7	103.8						126.2
360		233.5	104.9						127.5
370		231.0	105.8						128.6
380		235.0	107.8						130.0
390		233.5	108.3						131.5
400		236.5	109.3						133.5
410			110.2						135.0
420			111.0						137.0
430			111.8						139.0
440			112.7						140.2
450			113.8						
460			114.3						
470			115.0						
480			116.0						
490			117.5						
500			118.0						

Hole number	19	20	21	22	23	24	25	26	27
Location	SE/4 SE/4 S11,T21,N,R27E	NE/4 SE/4 S36,T22N,R27E	NE/4 SE/4 S19,T22N,R28E	NE/4 SW/4 S8,T22N,R28E	SW/4 SE/4 S32,T23N,R28E	NW/4 SE/4 S35,T23N,R28E	SE/4 SW/4 S26,T22N,R27E	NW/4 NE/4 S17,T22N,R27E	SW/4 SE/4 S9,T22N,R27E
Date	May 23, 1977	April 11, 1977	May 15, 1977	May 19, 1977	December 27, 1973	May 23, 1977	December 31, 1973	December 31, 1973	January 3, 1974
Equip. used	Enviro-Labs Inc.	Enviro-Labs Inc.	Enviro-Labs Inc.	Enviro-Labs Inc.	Phillips	Enviro-Labs Inc.	Phillips	Phillips	Phillips
Depth in feet	Temperature	Temperature	Temperature	Temperature	Temperature	Temperature	Temperature	Temperature	Temperature
10					60.7		63.4	60.3	63.9
20	61.9	63.7	61.5		63.6	61.7	65.9	62.8	66.7
30		64.9	63.0		62.8		67.0	63.2	67.1
40	64.9	66.0	64.2	79.0	63.5	65.3	68.8	64.4	67.3
50		67.1	65.3		64.4		70.4	65.3	69.8
60	66.7	68.4	66.2	84.9	65.2	66.9	72.0	66.5	70.4
70		69.3	66.7		65.5		74.0	66.8	70.8
80	68.0	70.3	67.5	93.2	66.1	68.2	75.3	67.9	72.0
90		71.1	68.2		66.3		75.7	69.0	73.0
100	69.3	72.1	69.1	99.5	66.5	69.0	78.0	70.0	73.5
110		72.9	69.6		66.7		79.5	71.7	74.7
120	70.5	73.6	70.2	105.8	66.6	69.8	82.0	72.4	75.5
130		74.3	70.7				83.7	74.0	76.2
140	71.6	75.2	71.2	112.5		70.2	84.2	74.7	79.5
150		75.9	72.0				86.8	75.5	77.8
160	72.7	76.5	72.7	118.4		70.7	88.7	76.0	81.8
170		77.0	73.8				90.2	77.5	83.0
180	73.6	77.9	74.8	122.9		71.0	91.5	79.4	83.7
190		78.8					93.0	80.2	84.9
200	74.8	79.7	77.4	126.5			94.5	80.8	85.6
210		80.2					96.0		86.4
220	75.6	81.3		130.3			97.2		87.0
230		82.0					98.3		
240	76.5	82.9		131.9			99.6		
250		83.5		133.0			101.2		
260	77.2	84.2					102.2		
270		84.9					102.8		
275	78.1								
280		85.6							
290		86.4							
300		87.1							

Hole number	28	29	30	31	32	33	34	35	36
Location	NW/4 SE/4 S19,T22N,R27E	NE/4 SE/4 S35,T23N,R27E	SW/4 SW/4 S29,T22N,R27E	NW/4 NE/4 S33,T22N,R27E	SE/4 SE/4 S29,T22N,R27E	SW/4 SW/4 S33,T22N,R27E	NW/4 NW/4 S17,T21N,R28E	SW/4 NE/4 S5,T21N,R28E	SE/4 NW/4 S15,T21N,R27E
Date	January 7, 1974	January 7, 1974	January 9, 1974	January 28, 1974	February 11, 1974	February 11, 1974	February 5, 1974	May 19, 1977	February 11, 1974
Equip. used	Phillips	Phillips	Phillips	Phillips	Phillips	Phillips	Phillips	Enviro-Labs Inc.	Phillips
Depth in feet	Temperature	Temperature	Temperature	Temperature	Temperature	Temperature	Temperature	Temperature	Temperature
10	65.8	58.3	70.2	62.0	66.5	60.3	62.9		
20	76.0	60.6	83.0	69.4	75.2	62.2	67.3		62.6
30	83.4	61.0	89.5	78.8	82.0	63.0	69.8		64.2
40	91.0	61.7	96.2	82.6	86.9	64.2	71.3		64.5
50	97.3	62.3	101.1	87.5	92.8	65.2	73.0	67.5	65.2
60	103.4	63.2	105.8	90.3	97.2	66.2	74.2	68.0	65.8
70	109.0	63.9	111.6	93.5	102.3	67.1	75.3		66.3
80	115.3	64.4	117.9	96.7	107.25	67.9	76.4	69.6	66.8
90	120.5	65.0	120.6	99.8	112.1	68.9	78.7		67.4
100	125.0	65.7	128.3	103.5	118.0	69.8	80.9	71.4	67.7
110	130.1	66.2	132.7	106.2	122.5	70.8	82.0		68.3
120	134.2	66.7	140.0	108.0	128.0	71.5	83.0	72.7	68.8
130	140.0	67.2	145.4	113.2	134.0	72.3	83.7		69.3
140	146.5	67.5	151.6	117.5	138.6	72.9	85.0	73.8	69.8
150	150.3	67.9	156.1	120.7	144.0	73.7	85.8		70.3
160	154.7	68.5	162.5	123.7	149.6	74.5	86.0	75.2	70.9
170	156.5	69.2	170.4	127.3	155.8	75.3	91.0		71.4
180	162.5	69.7	175.0	131.2	162.6	76.2	88.9	76.5	72.0
190	168.5	70.4	180.5	133.1	164.7	77.0	89.7		72.6
200	175.3	71.0	185.2	136.2	167.3	77.8	90.5	77.7	73.2
210	179.2	71.3	193.0	141.0	170.25	78.7	91.4		
220	182.5		203.2	144.2	173.7	79.9	92.5	78.8	
230			207.5	147.5	177.1	80.3	93.5		
240			212.1	151.3	186.4	81.4	94.2	79.7	
250			219.5	154.0	190.5	82.2	95.1		
260			223.0	156.0	194.25	82.9	96.2	80.6	
270			228.0	158.5	197.8	83.6	97.2		
280			231.5		201.2	84.3	98.3	81.5	
290			236.0		204.6	85.1	99.3		
300			243.0		207.5	85.8	100.4	82.4	
310					211.0	86.5	101.3		
320					211.8	86.7	102.2	83.7	
330					212.3	87.4			
340					212.9	88.0		84.7	
350					214.1	88.7			
360					215.5	89.3		85.5	
370					216.5	89.8			
380					217.6	90.5		86.4	
390					218.6	91.4			
400					219.7	91.8		87.0	
410					220.8	92.6			
416								87.44	
420					221.3	93.3			
426						92.8			
430					222.2				
440					223.0				
450					223.9				
454					224.2				

Hole number	37	38	39	40	41	42	44	45	46
Location	SE/4 NE/4 S29,T22N,R27E	NW/4 SW/4 S27,T22N,R27E	SW/4 SE/4 S21,T22N,R27E	NE/4 SW/4 S23,T22N,R27E	NW/4 SW/4 S7,T22N,R28E	SW/4 SW/4 S9,T22N,R28E	SE/4 NW/4 S3,T22N,R28E	NE/4 SW/4 S5,T22N,R28E	SW/4 NE/4 S11,T22N,R27E
Date	February 7, 1974	May 19, 1977	February 19, 1974	March 5, 1974	March 6, 1974	March 6, 1974	May 23, 1977	May 15, 1977	May 23, 1977
Equip. used	Phillips	Enviro-Labs Inc.	Phillips	Phillips	Phillips	Phillips	Enviro-Labs Inc.	Enviro-Labs Inc.	Enviro-Labs Inc.
Depth in feet	Temperature	Temperature	Temperature	Temperature	Temperature	Temperature	Temperature	Temperature	Temperature
10	75.2		64.2	54.4?	61.4	64.6			
20	94.8	63.8	76.3	57.7?	68.7	76.3	68.0	59.0	58.1
30	103.0	67.8	81.7	58.7?	75.1	84.7		60.4	
40	114.4	69.4	86.8	58.7	78.3	88.6	75.7	61.0	60.1
50	123.5	72.0	91.6	61.8	81.5	92.3		61.3	
60	134.25	74.7	97.2	64.4	84.3	97.7	79.9		62.2
70	144.0	77.0	102.5	69.8	86.9	102.5		63.0	
80	154.3	79.0	107.6	71.5	91.9	107.7	85.6	63.7	63.5
90	162.35	81.0	112.8	73.0	93.2	113.5		64.4	
100	171.1	82.8	118.1	74.5	96.1	119.1	88.3	65.1	64.8
110	177.4	86.0	121.9	76.0	99.0	124.0		65.7	
120	187.9	88.3	125.2	77.7	101.4	127.6	91.3	66.2	65.7
130	194.2	90.9	130.3	81.8	103.3	134.0		66.9	
140	200.3	92.7	134.9	82.4	105.9	140.2	96.1	67.6	66.4
150	202.7	95.4	137.8	84.0	108.2	145.7		68.2	
160	204.7	97.5	144.8	84.8	110.6	149.5	100.2	68.5	68.9
170	209.8	99.7	151.0	86.2	113.2	154.2		69.1	
180	216.3	102.2	154.9	87.3	115.9	158.3	103.2	69.6	70.5
190	223.7	104.2	160.4	88.3	120.2	162.4		70.2	
200	231.0	106.7	164.5	89.6	122.3	165.3	103.5	70.7	71.6
210	237.5	108.5	169.1	90.8	124.5	169.2			
220	244.3		174.5	91.4*	128.0	173.9	103.2	71.6	73.0
230	251.2		178.9		131.0	177.5		72.0	
240	257.4		183.6		133.0	178.3	102.7	72.3	74.5
250	264.5		187.8		132.2	177.1		72.7	
260	270.25		192.0		135.0	175.0		73.2	75.9
270	276.8		196.3		137.7	173.0		73.8	
280	282.9		200.3		139.3	170.7		74.1	
290	286.4		203.3		141.0	168.8		74.5	
295	291.3								
299			205.8						
300					143.0	167.7		74.8	
310					145.0	167.5*		75.6	
318					147.0				

\*A temperature of 91.4 was reached at 212 ft in hole no. 40; a temperature of 167.5 was reached at 305 ft in hole no. 42.

Hole number	47	48	49	50	51	52	53	AH-1	AH-2
Location	SW/4 NE/4 S11,T22N,R28E	SE/4 NW/4 S5,T21N,R27E	NW/4 NE/4 S5,T22N,R27E	SE/4 NW/4 S3,T22N,R27E	NE/4 NE/4 S15,T22N,R27E	NW/4 NW/4 S9,T22N,R28E	SE/4 SE/4 S1,T21N,R27E	NW/4 SW/4 S12,T22N,R26E	SW/4 SW/4 S12,T22N,R26E
Date	March 25, 1974	April 1, 1974	April 3, 1977	April 3, 1977	April 11, 1977	October 7, 1977	October 21, 1977	July 26, 1973	August 6, 1973
Equip. used	Phillips	Phillips	Enviro-Labs Inc.	Enviro-Labs Inc.	Enviro-Labs Inc.	Enviro-Labs Inc.	Enviro-Labs Inc.	Phillips	Phillips
Depth in feet	Temperature	Temperature	Temperature	Temperature	Temperature	Temperature	Temperature	Temperature	Temperature
10	66.7	58.7	53.4	50.2	55.9	82.5		103.5	78.8
20	70.2	65.4	58.7	55.2	60.4	92.1	64.6	107.1	190.2
30	76.8	66.3	60.5	57.8	63.0	100.9		129.9	190.8
40	77.7	80.9	61.9	58.7	64.6	110.7	66.2	147.4	191.8
50	78.0	81.4	63.1	59.4	65.8	118.6		168.6	192.5
60	79.7	82.3	64.0	60.3	66.4	126.3	67.8	183.8	193.4
70	79.0	83.8	64.9	60.8	67.3	134.6		197.2	194.1
75								201.3	
80	79.6	83.5	65.6	61.4	68.2	142.0	69.4		193.1
90	78.7	86.7	66.4	61.9	69.1	149.7			188.6
100	80.4	86.8	67.1	62.4	70.2	157.3	71.1		186.4
110	80.5	87.2	67.8	63.0	70.9	169.3			183.2
120	81.2	88.6	68.5	63.4	71.8	175.7	72.3		180.5
130	81.6	86.2	69.2	63.9	72.7	178.3			176.0
140	82.2	88.6	69.9	64.4	73.8	180.7	73.9		173.5
145									172.0
150	82.4	88.3	70.8	64.9	74.5	182.5			
160	85.0	87.9	71.6	65.3	75.4	184.3	75.7		
170	84.6	88.6	72.3	65.7	76.3	186.4			
177				66.2					
180	83.7	94.1	73.0		77.0	188.2	76.8		
190	84.3	92.2	73.9		78.1	190.4			
200	86.0	93.4	74.8		79.0	191.1	78.3		
210		96.1	75.7		79.7	192.4			
220		98.3	76.5		80.8	193.3	79.3		
230		95.8	77.4		81.5	193.3			
240		96.5	78.3		82.2	193.3	80.8		
250		96.7*	79.2		83.1	193.1			
260			80.1		84.0	192.7	82.4		
270			81.0		84.7	192.4			
280			81.77		85.6	192.3	82.9		
290					86.4	191.7			
300						190.5	83.3		
310						190.9			
320						189.8	84.4		
330						189.6			
340						189.5	86.9		
350						188.2			
360						188.2	87.6		
370						188.1			
380						188.0	88.2		
390						187.4			
400						187.0	89.2		
410						187.0			
420						188.1	90.1		
430						188.2			
440						188.8	91.4		
450						188.8			
460						188.9	93.2		
470						189.3			
480						188.6			
490						188.3			
500						188.1			
510						187.0			
520						185.4			
530						183.7			
540						182.3			
550						181.0			
560						180.7			
568						180.3			

\*A temperature of 96.7 was reached at 246 ft in hole no. 48.

77

Hole number	AH-3	AH-4	AH-5	AH-6	AH-7	AH-8	DH-10	AH-11	DH-12
Location	SW/4 NE/4 S11,T22N,R26E	NE/4 NW/4 S14,T22N,R26E	SW/4 SW/4 S36,T23N,R26E	NW/4 NE/4 S35,T23N,R26E	NW/4 SE/4 S2,T22N,R26E	SE/4 NE/4 S14,T22N,R26E	NE/4 SE/4 S12,T22N,R26E	SE/4 SW/4 S35,T23N,R26E	SW/4 NW/4 S31,T23N,R27E
Date	July 2, 1973	July 9, 1973	January 30, 1974	July 2, 1973	July 2, 1973	August 6, 1973	July 12, 1973	July 12, 1973	July 2, 1973
Equip. used	Phillips	Phillips	Phillips	Phillips	Phillips (poor data)	Phillips	Phillips	Phillips	Phillips
Depth in feet	Temperature	Temperature	Temperature	Temperature	Temperature	Temperature	Temperature	Temperature	Temperature
10	92.2	98.0	67.3	83.2	88.6	88.6	65.8	86.8	66.1
20	90.1	63.4	66.6	78.3	86.4	87.3	65.6	84.1	67.6
30	89.0	62.7	66.6	71.6		77.0	69.0	83.2	71.1
40	85.5	64.2	67.1	74.9	65.4	78.0	71.9	62.4	78.6
50	76.7	65.5	72.5	78.9	66.2	81.8	74.6	62.3	75.8
60	76.1	66.8	74.7		67.7	84.6	76.7	62.4	76.9
70	77.8	68.2	76.5		68.3	87.0	80.0	62.5	78.7
80	80.2	69.5	77.7		85.2*	90.1	82.4	62.7	87.2
90			78.8		83.2	92.2	85.0	62.9	87.6
96	82.3		79.5						
100	85.0				82.8	94.7	86.8	63.2	89.9
110					82.3	96.9	89.8		92.7
119					75.3	98.4			
120							92.7		94.6
130							95.6		95.4
140							98.0		98.9
150							98.7		100.1
160									102.2
170									103.0

\*A temperature of 85.2 was reached at 75 ft in hole no. AH-7.

Hole number	AH-13	AH-14	DH-15	DH-16	DH-17	AH-18	AH-19	AH-20	USGS-1
Location	SE/4 SW/4 S3,T22N,R26E	SW/4 NE/4 S24,T22N,R26E	SW/4 SE/4 S1,T22N,R26E	NE/4 NW/4 S13,T22N,R26E	SE/4 NE/4 S11,T22N,R26E	SE/4 SW/4 S1,T22N,R26E	NE/4 NE/4 S1,T22N,R26E	SW/4 NW/4 S13,T22N,R26E	NW/4 SW/4 S17,T22N,R27E
Date	July 9, 1973	May 15, 1977	November 12, 1973	November 12, 1973	November 12, 1973	February 5, 1974	February 6, 1975	February 5, 1974	August 23, 1978
Equip. used	Phillips	Enviro-Labs Inc.	Phillips	Phillips	Phillips	Phillips	Phillips	Phillips	Enviro-Labs Inc.
Depth in feet	Temperature	Temperature	Temperature	Temperature	Temperature	Temperature	Temperature	Temperature	Temperature
10	93.3		111.2	208.0	81.9	83.4	60.98	75.5	67.5
20	87.4	64.8	184.0	214.0	88.0	101.2	88.88	117.3	62.6
30	80.4	68.9	195.0	220.3	103.0	131.7	110.30	149.5	63.1
40	61.8	72.1	214.0	230.0	110.5	138.5	127.22	195.7	64.2
45				235.0					
50	58.2	75.2	229.0		117.0	140.3	138.56	202.3	65.1
52							140.81		
60	57.8	77.7	239.0		124.0			205.2	66.4
70	57.8	79.9			126.0			218.1	67.8
80	58.1				127.9			225.5	69.0
90	58.4				130.0			230.0	70.0
96									70.5
100	58.8				132.5				
110	59.0								
117	59.4								
120									
130									
140									



Hole number	USGS-2	USGS-3	USGS-4	USGS-5
Location	NW/4 NW/4 S18,T22N,R27E	NE/4 NW/4 S24,T22N,R26E	NE/4 SW/4 S30,T22N,R27E	SW/4 SE/4 S32,T23N,R28E
Date	July 11, 1978	May 15, 1977	May 15, 1977	May 15, 1977
Equip. used	Enviro-Labs Inc.	Enviro-Labs Inc.	Enviro-Labs Inc.	Enviro-Labs Inc.
Depth in feet	Temperature	Temperature	Temperature	Temperature
10	63.7			
20	66.6	63.7	58.8	58.5
30	71.8		59.4	60.4
40	75.6	67.5	62.6	61.5
50	79.1	68.7	63.3	62.2
60	83.3	69.6	63.7	62.8
70	87.3	70.7	64.2	63.3
80	90.5	72.0	64.8	63.9
90	93.4	73.2	65.3	64.4
100	95.5	74.5	65.8	64.8
110	96.3*		66.6	
120			67.1	
130			67.6	

\*A temperature of 96.3 was reached at 105 ft in hole no. USGS-2.

## REFERENCES

- Albers, J. P. (1964) Tertiary and Quaternary rocks, *in* Mineral and water resources of Nevada: Nevada Bureau of Mines and Geology Bulletin 65, 314 p.
- Axelrod, D. I. (1956) Mio-Pliocene floras from west-central Nevada: University of California Publication in Geologic Science, v. 33, p. 1-322.
- Bailey, E. H., and Phoenix, D. A. (1944) Quicksilver deposits in Nevada: Nevada University Bulletin, v. 38, no. 5 [41].
- Benoit, W. R. (1974) Water geochemistry and near-surface hydrology of the Brady's Desert Peak area, Churchill County Nevada: Phillips Petroleum Company Report, 13 p.
- \_\_\_\_\_. (1978a) The discovery and geology of the Desert Peak, Nevada, geothermal field, *in* Energy exploration and politics, F. L. Hill, coordinator: preprints from California Division of Oil and Gas, 11 p.
- \_\_\_\_\_. (1978b) The use of shallow and deep temperature gradients in geothermal exploration in northwestern Nevada using the Desert Peak thermal anomaly as a model: Geothermal Resource Council Annual Meeting, 1978, Transactions, v. 2, sec. 1, p. 45-47.
- Benoit, W. R., Sethi, D. K., Fertl, W. H., and Matthews, M. (1980) Society of professional well log analysts 21st annual logging symposium, 1980, Transactions, paper AA.
- Billingsley, P. R., and Locke, Augustus (1939) Structure of ore districts in the continental framework: New York, American Institute of Mining and Metallurgical Engineers; A.I.M.E. Transactions (1941) v. 144, p. 9-59.
- Bingler, E. C. (1978) Abandonment of the name Hartford Hill Rhyolite Tuff and adoption of new formation names for middle Tertiary ash-flow tuffs in the Carson City-Silver City area, Nevada: U.S. Geological Survey Bulletin 1457-D, 19 p.
- Bishop, A. S. (1970) The Pacific tourist—the 1884 transcontinental guide of travel from the Atlantic to the Pacific Ocean, F. E. Shearer and others, eds. (rpt.): New York, Crown Publishers Inc., 372 p.
- Blackwell, D. E. (1975) Interpretation of geothermal data from Desert Peak 29-1, Churchill County, Nevada: Phillips Petroleum Company unpublished report, 19 p.
- Bonham, H. F. (1961) Geology and mineral resources of Township 22 North—Ranges 26 and 27 East, Mount Diablo base and meridian, Churchill and Lyon Counties, Nevada: Southern Pacific Company unpublished report.
- \_\_\_\_\_. (1969) Geology and mineral deposits of Washoe and Storey Counties, Nevada: Nevada Bureau of Mines and Geology Bulletin 70, 140 p.
- Brogan, G. E., and Birkhahn, P. C. (1980) Faults and occurrences of geothermal anomalies: Semi-annual technical report no. 3, U.S. Geological Survey Geothermal Research Program, 40 p.
- Burke, D. B., and McKee, E. H. (1973) Mid-Cenozoic volcanotectonic features in central Nevada [abs.]: Geological Society of America, Abstracts with Programs, v. 5, no. 1, p. 18.
- Burke, D. B., and Silberling, N. H. (1973) The Auld Lang Syne Group, of late Triassic and Jurassic(?) age, north-central Nevada: U.S. Geological Survey Bulletin 1394-E, 14 p.
- Dakhnov, V. N. (1962) Geophysical well-logging—the application of geophysical methods—electrical well loggings (English translation): Colorado School of Mines Quarterly, v. 57, no. 2, 445 p.
- Dallon, H. R. (1979) Geophysical survey, Desert Peak, Churchill County, Nevada: Phillips Petroleum Company unpublished report, 3 p.
- Dey, A., and Morrison, H. F. (1977) An analysis of the bipole-dipole resistivity method for geothermal exploration: Lawrence Berkeley Laboratory Report 6332, 60 p.
- Ellis, A. J., and Mahon, W. A. J. (1977) Chemistry and geothermal systems: New York, Academic Press, 392 p.
- Erdman, J. G. (1974) Geothermal exploration, Brady's-Desert Peak, Nevada—thermal water characterizations: Phillips Petroleum Company unpublished report, 7 p.
- Evernden, J. F., and James, G. T. (1964) Potassium-argon dates and the Tertiary floras of North America: American Journal of Science, v. 262, p. 945-974.
- Facca, G., and Tonani, F. (1967) The self sealing geothermal field: Bulletin Volcanologique, v. 30, p. 271.
- Garside, L. J. (1974) Geothermal exploration and development in Nevada through 1973: Nevada Bureau of Mines and Geology Report 21, 12 p.
- Garside, L. J., and Schilling, J. H. (1979) Thermal waters of Nevada: Nevada Bureau of Mines and Geology Report 91, 163 p.
- Godwin, L. H., Haigler, L. B., Rioux, R. L., White, D. E., Muffler, L. P. J., and Weyland, R. G. (1971) Classification of public lands valuable for geothermal steam and associated geothermal resources: U.S. Geological Survey Circular 647.
- Habiger, R. M. (1979) Gravity data for Desert Peak: Phillips Petroleum Company unpublished report, 1 p.
- Hansen, A. (1969) Report on flow test on Brady Hot Springs 5 steam well: Magma Energy Inc. unpublished report, 15 p.
- Harrill, J. R. (1970) Water-resources appraisal of the Granite Springs Valley area, Pershing, Churchill and Lyon Counties, Nevada: Nevada Department of Conservation and Natural Resources, Water Resources-Reconnaissance Series Report 55.
- Hiner, J. E. (1979) Geology of the Desert Peak geothermal anomaly—Churchill County, Nevada: unpublished M.S. thesis, University of Nevada, Reno.
- Hose, R. K., and Taylor, B. E. (1974) Geothermal systems of northern Nevada: U.S. Geological Survey Open-file Report 74-271, 27 p.
- Houghton, J. G., Sakamoto, C. M., and Gifford, R. O. (1975) Nevada's weather and climate: Nevada Bureau of Mines and Geology Special Publication 2, 78 p.
- Hyndman, D. W. (1972) Petrology of igneous and metamorphic rocks: New York, McGraw-Hill, 533 p.
- James, R. (1966) Measurement of steam-water mixtures discharging at the speed of sound to the atmosphere: New Zealand Engineering, v. 21, no. 10, p. 437-441.
- Johnson, M. G. (1977) Geology and mineral deposits of Pershing County, Nevada: Nevada Bureau of Mines and Geology Bulletin 89, 115 p.
- King, Clarence (1878) Systematic geology—U.S. geological exploration of the fortieth parallel, v. 1: Washington, Government Printing Office.
- Lincoln, F. C. (1923) Mining districts and mineral resources of Nevada: Reno, Nevada Newsletter Publishing Company.
- Locke, A., Billingsley, P. R., and Mayo, E. B. (1940) Sierra Nevada tectonic patterns: Geological Society of America Bulletin, v. 51, no. 4, p. 513-539.
- Mariner, R. H., Presser, T. S., Rapp, J. B., and Willey, L. M. (1975) The minor and trace elements, gas, and isotope compositions of the principal hot springs of Nevada and Oregon: U.S. Geological Survey Open-file Report, 27 p.
- McJannet, G. S. (1957) Geology of the Pyramid Lake-Red Rock Canyon area, Washoe County, Nevada: unpublished M.A. thesis, University of California, Los Angeles.
- Meidav, T., and Tonani, F. (1975) A critique of geothermal exploration techniques: 2nd United Nations symposium on the development and use of geothermal resources, San Francisco, 1975, Proceedings, v. 1, p. 1143-1155.
- Middleton, W. M. (1962) Data and comments on geothermal steam wells at Brady Hot Springs, Nevada: Thermal Power Company unpublished report, 8 p.
- Morris, D. A. (1978) Petrographic analysis of chip samples geothermal well B21-2, Desert Peak, Nevada: Phillips Petroleum Company unpublished report DAM-154-78, 2 p.
- Morrison, R. B. (1964) Lake Lahontan—geology of southern Carson Desert, Nevada: U.S. Geological Survey Professional Paper 401.
- Muffler, L. P. J., and Cataldi, R. (1977) Methods for regional assessment of geothermal resources: U.S. Geological Survey Open-file Report 77-870, 76 p.
- Nathenson, M., Urban, T. C., and Diment, W. H. (1979) Approximate solution for the temperature distribution caused by flow up a fault and its application to temperatures measured in a drill hole at Raft River geothermal area, Cassia County, Idaho: Geothermal Resources Council Annual Meeting, 1979, Transactions, p. 477-480.
- Oesterling, W. A., and Anctil, R. J. (1962) Geological and economic appraisal of geothermal steam resources at Brady Hot Springs, Nevada: Southern Pacific Company unpublished report.
- Olmsted, F. H., and Glancy, P. A., Harrill, J. R., Rush, F. E., and Van Denburgh, A. S. (1975) Preliminary hydrogeologic appraisal of selected hydrothermal systems in northern and central Nevada: U.S. Geological Survey Open-file Report 75-76, 274 p.

- Paher, S. W. (1970) Nevada ghost towns and mining camps: Berkeley, Howell-North, 492 p.
- Palmason, G. (1975) Geophysical methods in geophysical exploration: 2nd United Nations symposium on the development and use of geothermal resources, San Francisco, 1975, Proceedings, v. 2, p. 1175-1185.
- Petrovich, R. (1979) Scale in well B21-2 Desert Peak geothermal field: Phillips Petroleum Company unpublished report, 6 p.
- Pritchard, J. I., and Meidav, H. T. (1974) Electrical resistivity survey of the Brady Hot Springs prospect—Lyon and Churchill Counties, Nevada: Phillips Petroleum Company unpublished report, 27 p.
- Proffett, J. M. (1977) Cenozoic geology of the Yerington district, Nevada, and implications for the nature and origin of Basin and Range faulting: Geological Society of America Bulletin, v. 88, p. 247-266.
- Proffett, J. M., and Proffett, B. H. (1976) Stratigraphy of the Tertiary ash-flow tuffs in the Yerington district, Nevada: Nevada Bureau of Mines and Geology Report 27, 28 p.
- Riehle, J. R., McKee, E. H., and Speed, R. C. (1972) Tertiary volcanic center, west-central Nevada: Geological Society of America Bulletin, v. 83, p. 1383-1396.
- Roberts, R. J., Hotz, P. E., Gilluly, J., and Ferguson, H. G. (1958) Paleozoic rocks of north-central Nevada: American Association of Petroleum Geologists Bulletin, v. 42, no. 12, p. 2813-2857.
- Roberts, R. J., Montgomery, K. M., and Lehner, R. E. (1967) Geology and mineral resources of Eureka County, Nevada: Nevada Bureau of Mines and Geology Bulletin 64, 152 p.
- Rudisill, J. M. (1978) Recent reservoir engineering developments at Brady Hot Springs, Nevada, Ramey and Kruger, eds.: 4th workshop on geothermal reservoir engineering, sponsored by the Stanford Geothermal Program.
- Rudisill, J. M., and Dykstra, H. (1978) Injection test for Brady's Hot Springs, Nevada: 4th invitational well-testing symposium, Lawrence Berkeley Laboratories, 1978, Proceedings.
- Russell, I. C. (1885) Geological history of Lake Lahontan, a Quaternary lake of northwestern Nevada: U.S. Geological Survey Monograph 11.
- Sacramento Daily Union, December 9, 1964, p. 1, col. 6.
- Sales, J. K. (1966) Structural analysis of the Basin and Range Province in terms of wrench-faulting: unpublished Ph.D. thesis, University of Nevada, Reno.
- Sethi, D. K., and Fertl, W. H. (1979) Geophysical well logging operations and log analysis in geothermal well Desert Peak no. B23-1: Los Alamos Scientific Laboratory informal report LA-8254-MS, 69 p.
- Silberling, N. J., and Roberts, R. J. (1962) Pre-Tertiary stratigraphy and structure of northwestern Nevada: Geological Society of America Special Paper 72.
- Speed, R. C. (1976) Geologic map of the Humboldt Lopolith and surrounding terrane, Nevada: Geological Society of America map MC-14 (with text).
- Speed, R. C., and Jones, T. A. (1969) Synorogenic quartz sandstone in the Jurassic mobile belt of western Nevada—Boyer Ranch Formation: Geological Society of America Bulletin, v. 80, p. 2551-2584.
- Stearns, D. W. (1971) Mechanisms of drape folding in the Wyoming province: Wyoming Geological Association, Guidebook 23rd Annual Field Conference, p. 125-143.
- Stewart, J. H. (1980) Geology of Nevada: Nevada Bureau of Mines and Geology Special Publication 4, 136 p.
- Stewart, J. H., and Carlson, J. E. (1978) Geologic map of Nevada: U.S. Geological Survey, scale 1:500,000.
- Thompson, G. A. (1956) Geology of the Virginia City quadrangle, Nevada: U.S. Geological Survey Bulletin 1042-C.
- Trexler, D. T., Bell, E. J., and Roquemore, G. R. (1978) Evaluation of lineament analysis as an exploration technique for geothermal energy, western and central Nevada—final report for the period June 1976-October 1978: Department of Energy, Division of Geothermal Energy, contract EY-76-S-08-0671.
- Urban, T. C., Diment, W. H., and Nathenson, M. (1978) East Mesa geothermal anomaly, Imperial County, California—significance of temperatures in a deep drill hole near thermal equilibrium: Geothermal Resources Council Annual Meeting, 1978, Transactions, p. 667-671.
- U.S. Geological Survey (1977) Resource evaluation for Geothermal Food Processors, Inc. geothermal loan guarantee application: U.S. Geological Survey unpublished report, 13 p.
- Vanderburg, W. O. (1940) Reconnaissance of mining districts in Churchill County, Nevada: U.S. Bureau of Mines Information Circular 7093.
- Voegtly, N. E. (1981) Reconnaissance of the Hot Springs Mountains and adjacent areas, Churchill County, Nevada: U.S. Geological Survey Open-file Report 81-134, 10 p.
- Vozoff, K. (1972) The magnetotelluric method in the exploration of sedimentary basins: Geophysics, v. 37, no. 1, p. 98.
- Wallace, R. E. (1964) Structural evolution, in Mineral and water resources of Nevada: Nevada Bureau of Mines and Geology Bulletin 65, 314 p.
- Willden, R., and Speed, R. C. (1974) Geology and mineral deposits of Churchill County, Nevada: Nevada Bureau of Mines and Geology Bulletin 83, 95 p.
- White, D. E. (1970) Geochemistry applied to the discovery, evaluation, and exploitation of geothermal energy resources: United Nations symposium on the development and utilization of geothermal resources, 1970, Proceedings, v. 1, p. 58-80.
- (1973) Characteristics of geothermal resources, in Geothermal energy, resources, production, stimulation: Stanford, Stanford University Press, 360 p.
- Yager, J. P. (1971) The Yager journals—diary of a journey across the plains: Nevada Historical Society Quarterly, v. 14, no. 1.
- Yeamans, F. L. (1980) Summary of water level changes from Desert Peak B23-1 flow test, November 9-20, 1979: Phillips Petroleum Company unpublished report, 2 p.
- Ziagos, J. P., and Blackwell, D. D. (1981) A model for the effect of horizontal fluid flow in a thin aquifer on temperature-depth profiles: Geothermal Resources Council, Transactions, v. 5, p. 221-223.
- Zoback, M. L., and Thompson, G. A. (1978) Basin and range rifting in northern Nevada—clues from a mid-Miocene rift and its subsequent offsets: Geology, v. 6, no. 2, p. 111-116.

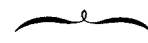

**PLATES**  
*(in pocket)*

- Plate 1—Shallow Temperature-Gradient Map
- Plate 2—Isothermal Map—100-Foot Depth
- Plate 3—Isothermal Map—300-Foot Depth
- Plate 4—Roving Dipole Apparent Resistivity Anomaly Map
- Plate 5—Total Field Apparent Conductance Map with Selected Temperature-Gradient Contours
- Plate 6—Equilibrium Temperature Profiles of Geothermal Wells and Stratigraphic Tests
- Plate 7—Magnetotelluric Slice Map at a Depth of 1000 Feet Showing Minimum Apparent Resistivities
- Plate 8—Magnetotelluric Slice Map at a Depth of 4000 Feet Showing Minimum Apparent Resistivities
- Plate 9—Magnetotelluric Slice Map at a Depth of 8000 Feet Showing Minimum Apparent Resistivities
- Plate 10—Near-Surface Thermal Aquifer Map
- Plate 11—Elevations on the Top of Near-Surface Thermal Aquifers
- Plate 12—Estimated Depth to 400° Based on Gradients at the Bottom of the Holes
- Plate 13—Geologic Map of the Desert Peak Geothermal Area, Churchill County, Nevada
- Plate 14—Complete Bouguer Gravity Map with Lineaments and Mapped Faults

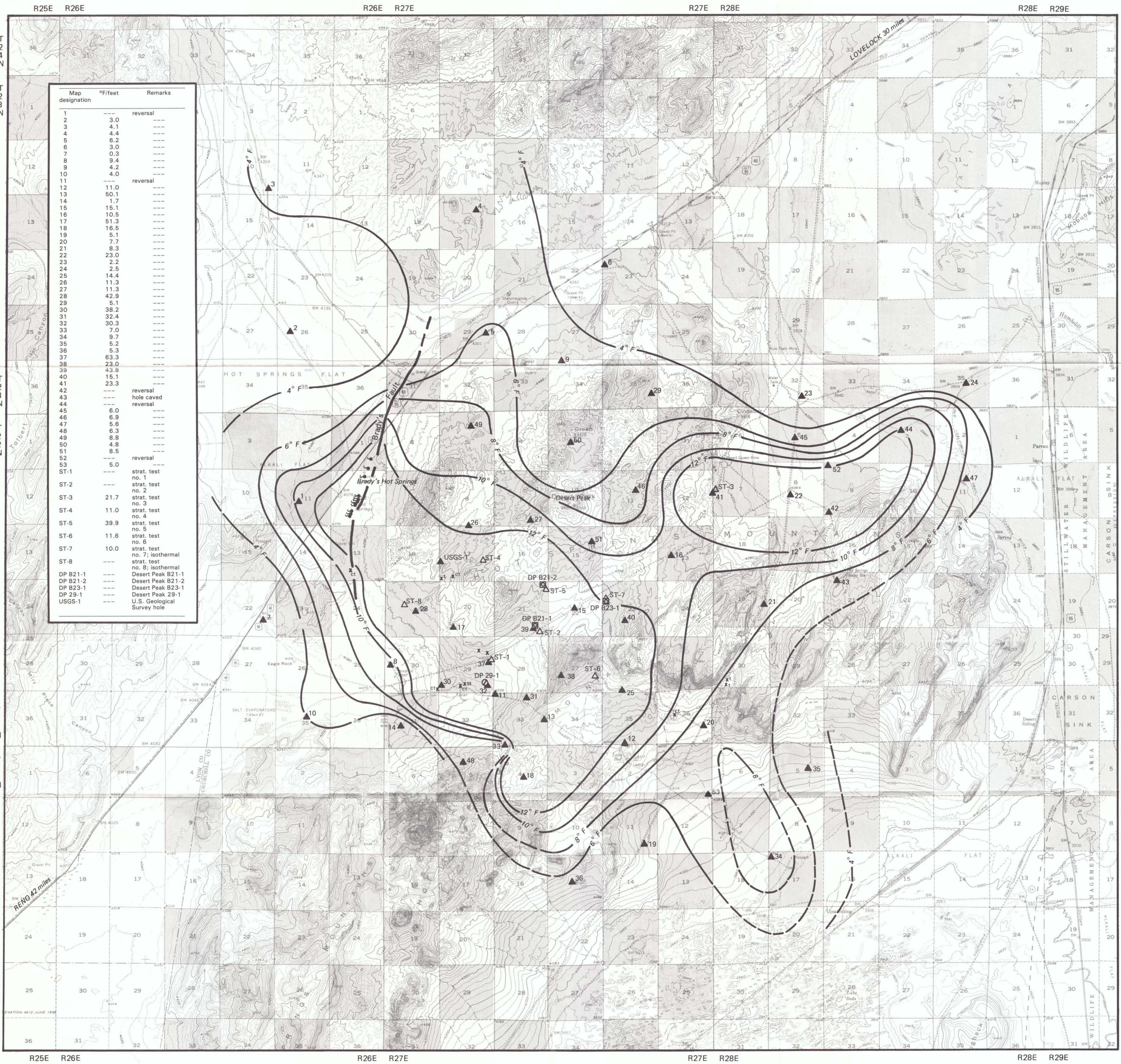

Map designation	°F/feet	Remarks
1	---	reversal
2	3.0	---
3	4.1	---
4	4.4	---
5	6.2	---
6	3.0	---
7	0.3	---
8	9.4	---
9	4.2	---
10	4.0	---
11	---	reversal
12	11.0	---
13	50.1	---
14	1.7	---
15	15.1	---
16	10.5	---
17	51.3	---
18	16.5	---
19	5.1	---
20	7.7	---
21	8.3	---
22	23.0	---
23	2.2	---
24	2.5	---
25	14.4	---
26	11.3	---
27	11.3	---
28	42.9	---
29	5.1	---
30	38.2	---
31	32.4	---
32	30.3	---
33	7.0	---
34	9.7	---
35	5.2	---
36	5.3	---
37	63.3	---
38	23.0	---
39	43.8	---
40	15.1	---
41	23.3	---
42	---	reversal
43	---	reversal hole caved
44	---	reversal
45	6.0	---
46	6.9	---
47	5.6	---
48	6.3	---
49	8.8	---
50	4.8	---
51	8.5	---
52	---	reversal
53	5.0	---
ST-1	---	strat. test no. 1
ST-2	---	strat. test no. 2
ST-3	21.7	strat. test no. 3
ST-4	11.0	strat. test no. 4
ST-5	39.9	strat. test no. 5
ST-6	11.6	strat. test no. 6
ST-7	10.0	strat. test no. 7; isothermal
ST-8	---	strat. test no. 8; isothermal
DP B21-1	---	Desert Peak B21-1
DP B21-2	---	Desert Peak B21-2
DP B23-1	---	Desert Peak B23-1
DP 29-1	---	Desert Peak 29-1
USGS-1	---	U.S. Geological Survey hole

Base from U. S. Geological Survey 1:62,500: Desert Peak, 1951; Fireball Ridge, 1957; Soda Lake, 1951; and Two Tips, 1957

temperature gradients shown are calculated on the difference in temperature between 100 feet of depth and the bottom of the drill hole

- ☒ shut-in producer
- geothermal well
- ⊙ non-commercial producer
- △ stratigraphic test
- ▲ temperature-gradient hole
- thermal spring
- x extinct thermal spring
- ct calcareous tufa
- ss siliceous sinter
- t travertine
- contour line, dashed where inferred
- Brady's Fault
- Southern Pacific Land Company

**SHALLOW TEMPERATURE-GRADIENT MAP**

SCALE 1:62,500

0 1 2 3 miles

0 1 2 3 4 kilometers

CONTOUR INTERVAL 2° F/100 FEET

The Nevada Bureau of Mines and Geology (NBMG), and the Nevada Mining Analytical Laboratory (NMAL), are charged by state law with the duty of investigating and reporting on the geology and mineral resources of the State. Operated as a unit, NBMG/NMAL are research and public service divisions of the University of Nevada Reno. NBMG/NMAL has no regulatory functions.

NBMG performs research and compiles information on Nevada's geology and mineral resources, and makes the information available through published maps and reports, unpublished data files and collections, and talks, correspondence, and personal contacts. NMAL provides assaying and mineral identification services. NBMG, through its affiliation with the National Cartographic Information Center, also provides information and assistance on base maps and airphotos.

NBMG/NMAL research includes all phases of Nevada's geology and mineral resources: basic geologic mapping and laboratory studies, geophysical and geochemical surveys, engineering geology, geologic considerations in urban and rural planning, the preparation of educational guides and booklets, statewide investigations of mineral commodities, the geology of ore deposits, and the exploration, development, mining, processing, utilization, and conservation of metal ores, industrial minerals, fossil and nuclear fuels, geothermal power, and water.

NBMG/NMAL offices are located in the Scrugham Engineering-Mines building on the University of Nevada Reno campus; office hours are 8:00—4:30, Monday through Friday.

For information concerning the geology and mineral resources of Nevada, contact: Director/State Geologist, Nevada Bureau of Mines and Geology, University of Nevada Reno, Reno, NV 89557-0088. A publication list will be sent upon request.

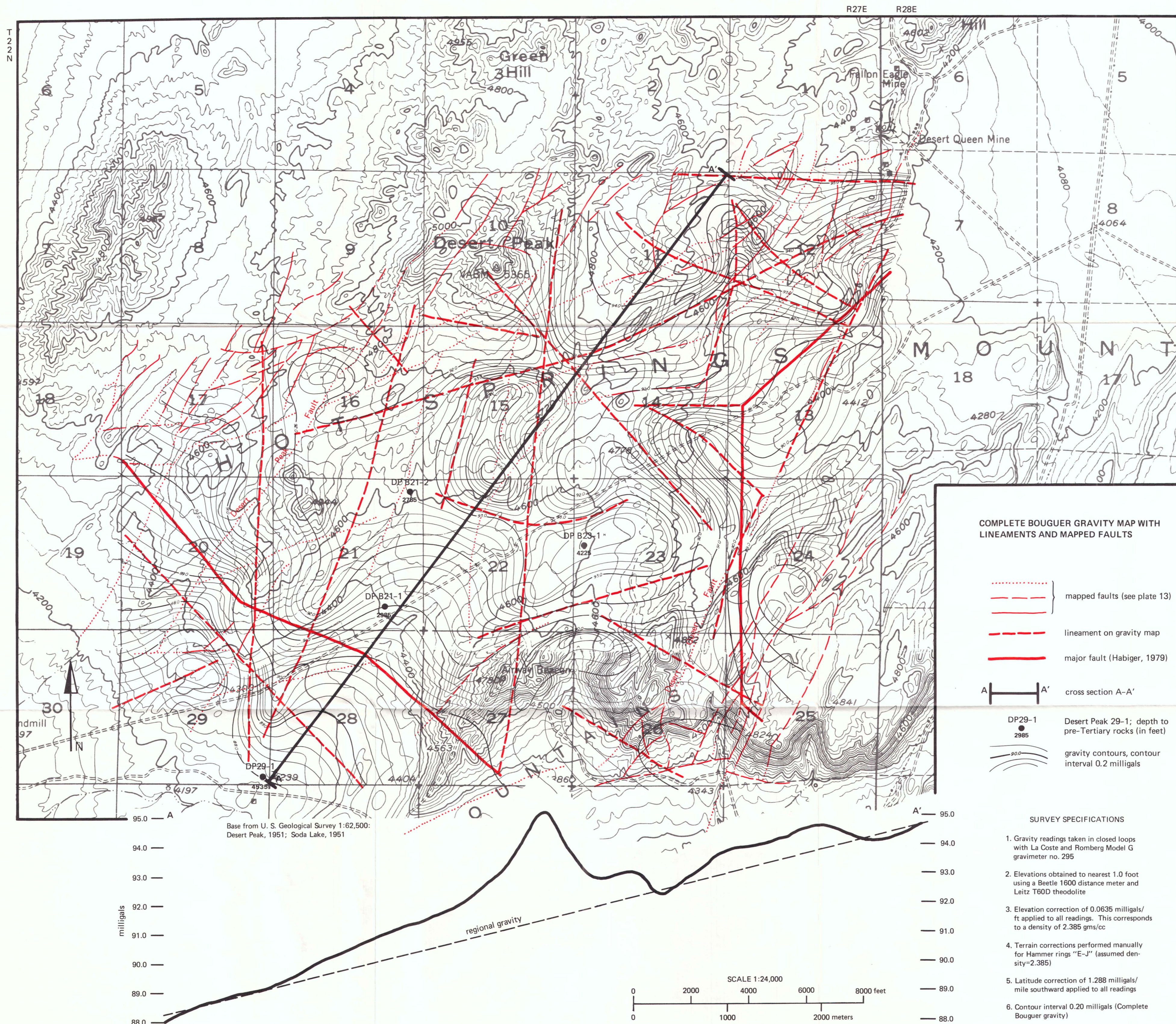

**COMPLETE BOUGUER GRAVITY MAP WITH LINEAMENTS AND MAPPED FAULTS**

- mapped faults (see plate 13)
- lineament on gravity map
- major fault (Habiger, 1979)
- cross section A-A'
- Desert Peak 29-1; depth to pre-Tertiary rocks (in feet)
- gravity contours, contour interval 0.2 milligals

**SURVEY SPECIFICATIONS**

1. Gravity readings taken in closed loops with La Coste and Romberg Model G gravimeter no. 295
2. Elevations obtained to nearest 1.0 foot using a Beetle 1600 distance meter and Leitz T60D theodolite
3. Elevation correction of 0.0635 milligals/ft applied to all readings. This corresponds to a density of 2.385 gms/cc
4. Terrain corrections performed manually for Hammer rings "E-J" (assumed density=2.385)
5. Latitude correction of 1.288 milligals/mile southward applied to all readings
6. Contour interval 0.20 milligals (Complete Bouguer gravity)

Base from U. S. Geological Survey 1:62,500: Desert Peak, 1951; Soda Lake, 1951

SCALE 1:24,000  
0 2000 4000 6000 8000 feet  
0 1000 2000 meters

milligals  
95.0  
94.0  
93.0  
92.0  
91.0  
90.0  
89.0  
88.0

95.0  
94.0  
93.0  
92.0  
91.0  
90.0  
89.0  
88.0

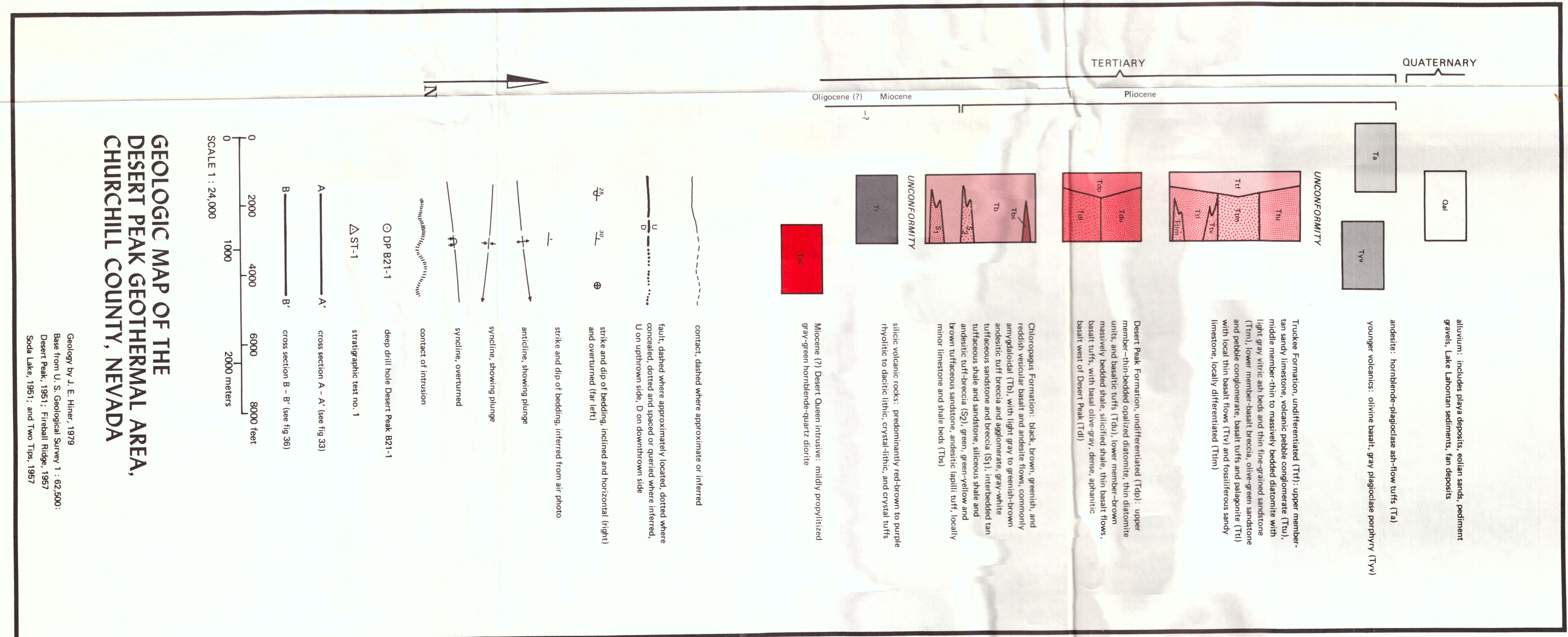
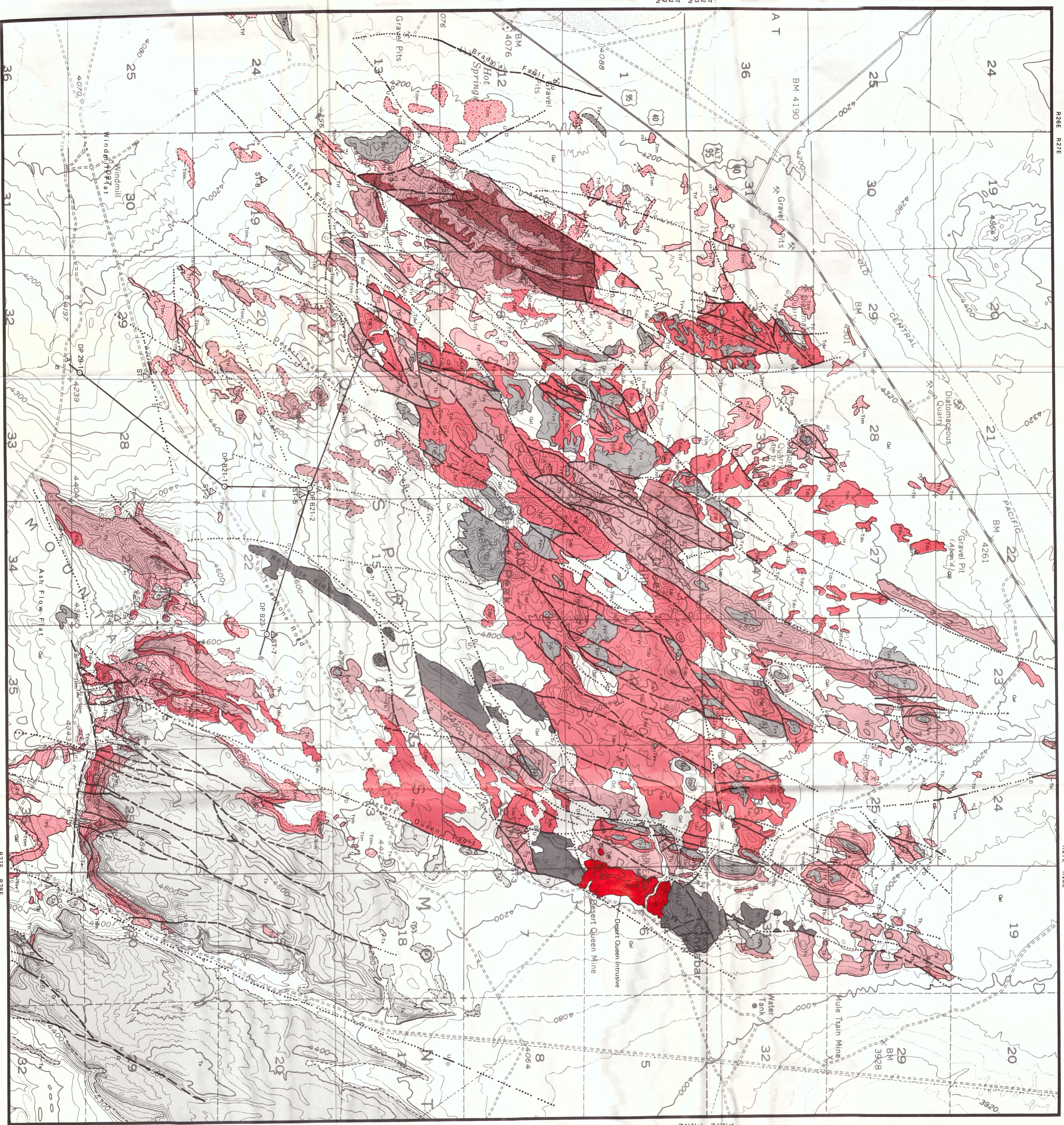





Map designation	Estimated depth (in feet)	Measured depth (in feet)	Remarks
ST-1	8000-9000	---	strat. test no. 1
ST-3	5300	---	strat. test no. 3
ST-4	5000	---	strat. test no. 4
ST-6	4400	---	strat. test no. 6
ST-8	8900	---	strat. test no. 8
DP B21-1	3400	1730	Desert Peak B21-1
DP B21-2	---	---	Desert Peak B21-2
DP B23-1	---	4320	Desert Peak B23-1
DP 29-1	~10,000	---	Desert Peak 29-1
Brady 1	---	4600	Brady no. 1
U-SP Brady 1	8900	---	Union-Southern Pacific Brady no. 1

Base from U. S. Geological Survey 1:62,500: Desert Peak, 1951; Fireball Ridge, 1957; Soda Lake, 1951; and Two Tips, 1957

- ☒ shut-in producer
- geothermal well
- △ stratigraphic test
- contour line, dashed where inferred
- A—A' cross section A-A' (see figure 33)
- B—B' cross section B-B' (see figure 36)

ESTIMATED DEPTH TO 400° F BASED ON GRADIENTS AT THE BOTTOM OF THE HOLES

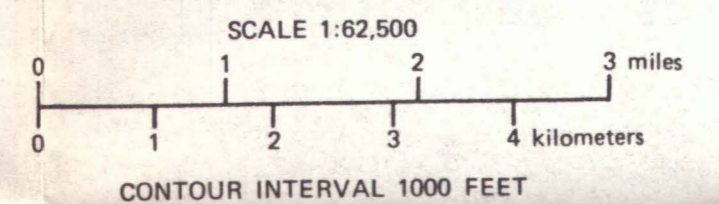



Base from U. S. Geological Survey 1:62,500:  
 Desert Peak, 1951; Fireball Ridge, 1957;  
 Soda Lake, 1951; and Two Tips, 1957

- known elevation (in feet)
- maximum elevation (in feet)
- 1, 30-1 hole numbers
- ST-1 stratigraphic test no. 1
- DP29-1 Desert Peak well 29-1
- contour line indicating elevation in feet

ELEVATIONS ON THE TOP OF NEAR-SURFACE THERMAL AQUIFERS

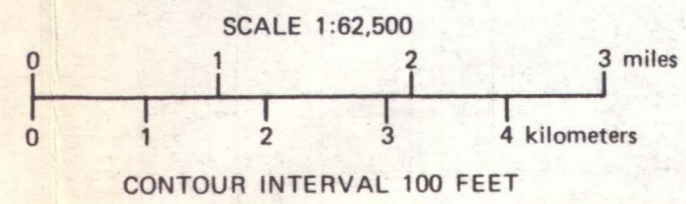

3700



Map designation	Temperature (°F)
1	102
8	237(7)
11	>207
13	>191
17	>140
18	>132
22	>182
28	>260
30	>168
31	>93(7)
33	178
42	103
44	193
52	239
ST-1	139
ST-8	298
DP21-2	243
DP29-1	194
AH-2	179
25-1	200
30-1	

Base from U. S. Geological Survey 1:62,500:  
Desert Peak, 1951; Fireball Ridge, 1957;  
Soda Lake, 1951; and Two Tips, 1957

- measured data point
- minimum data point
- 1, 24-1 hole numbers
- AH-2 USGS hole (from Olmsted and others, 1975)
- ST-1 stratigraphic test number 1
- DP21-2 Desert Peak well 21-2
- aquifer outline; solid where approximated and dashed where inferred
- temperature contour, dashed where inferred

NEAR-SURFACE THERMAL AQUIFER MAP

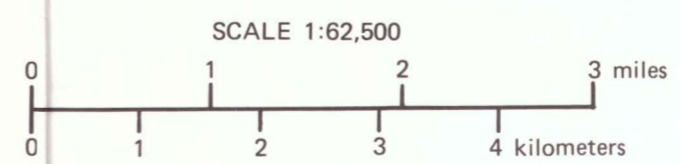

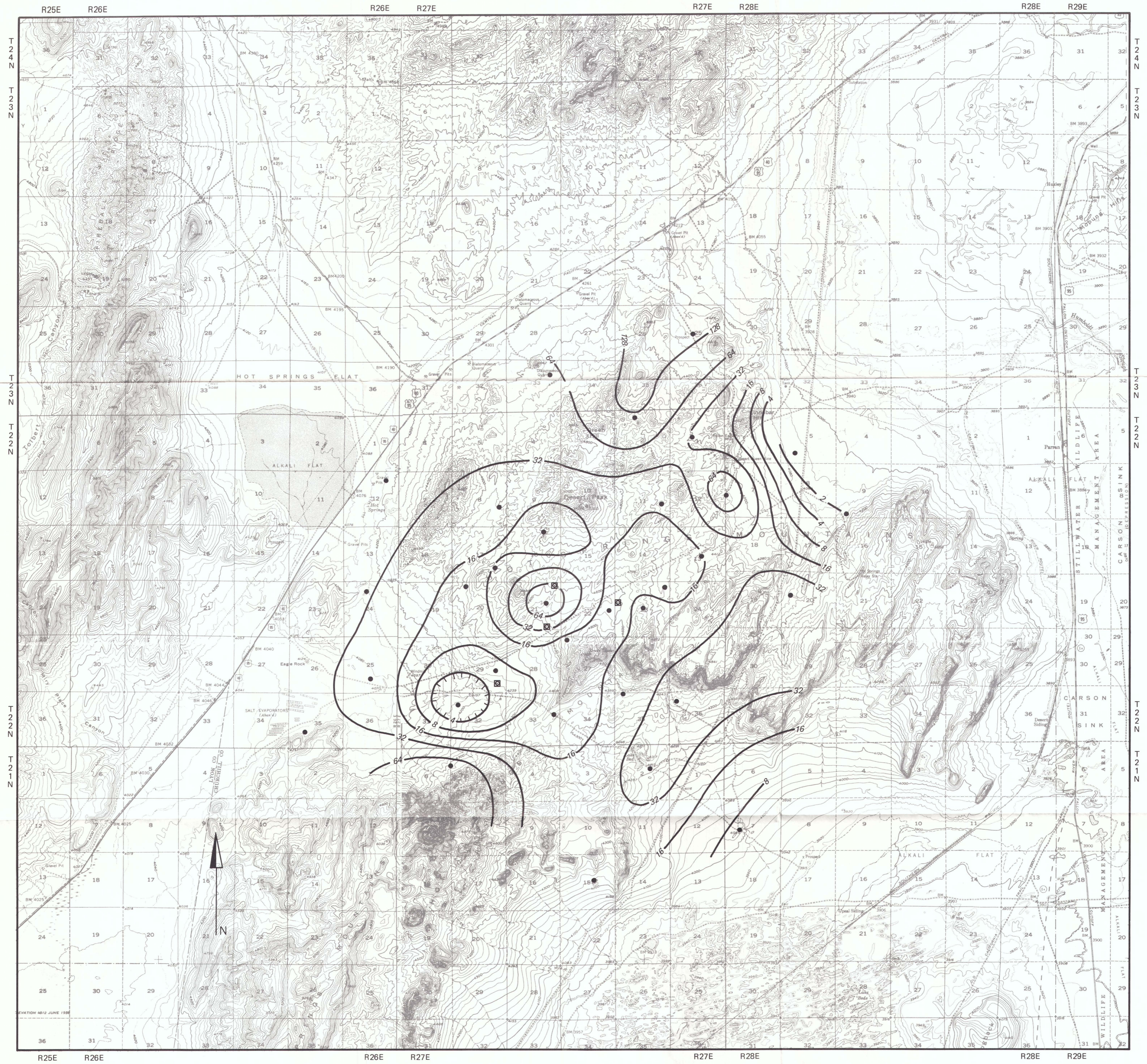

Base from U. S. Geological Survey 1:62,500:  
 Desert Peak, 1951; Fireball Ridge, 1957;  
 Soda Lake, 1951; and Two Tips, 1957

- magnetotelluric station
- ◻ deep tests
- 2 — contour lines showing values in ohm-meters
- ◌ enclosed low

MAGNETOTELLURIC SLICE MAP AT A DEPTH OF 8000 FEET  
 SHOWING MINIMUM APPARENT RESISTIVITIES

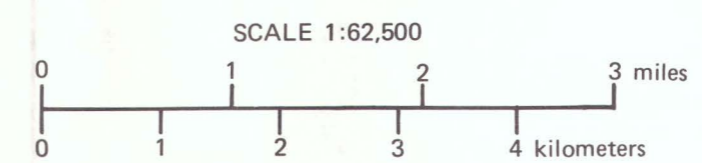

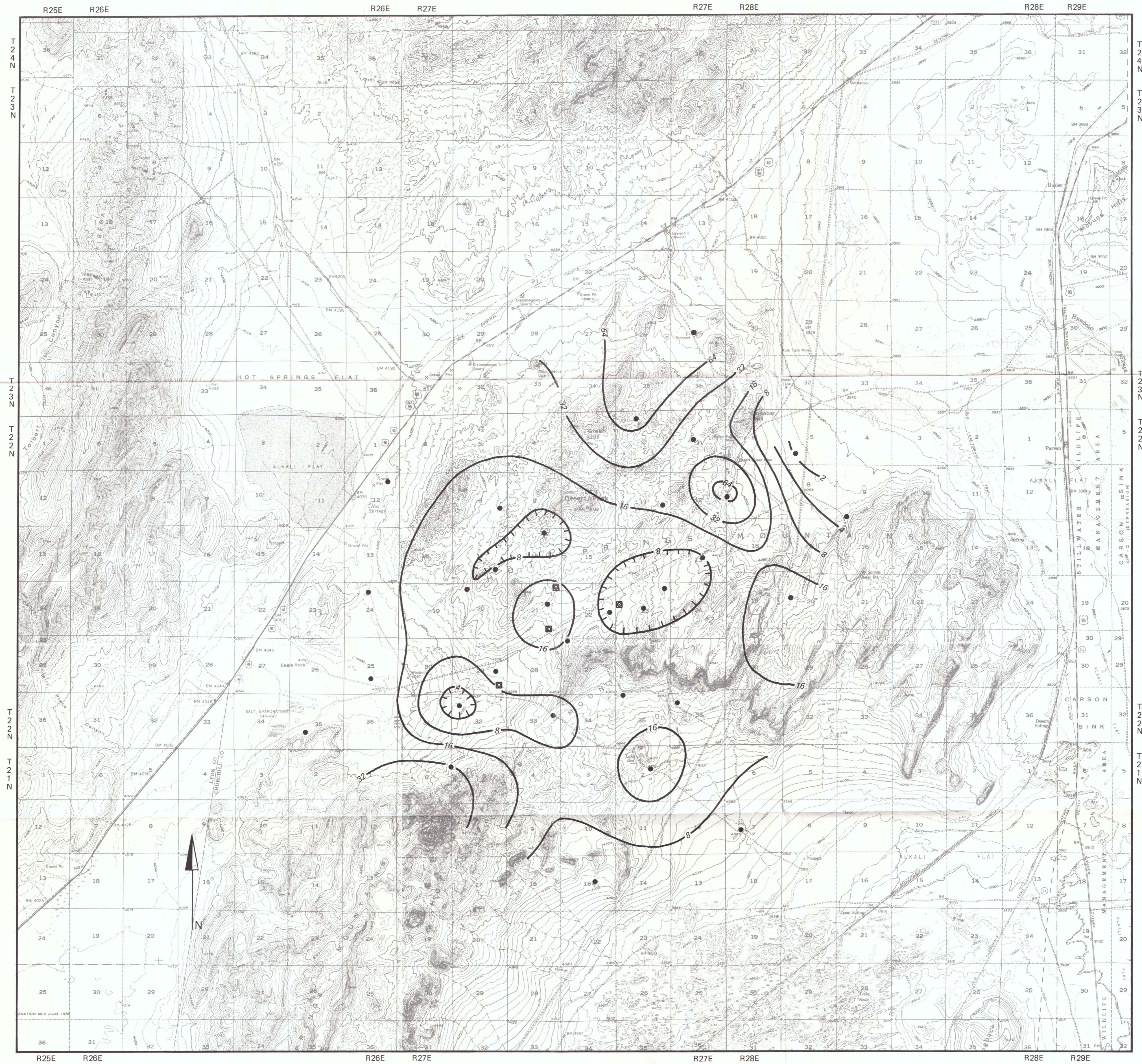

Base from U. S. Geological Survey 1:62,500:  
 Desert Peak, 1951; Fireball Ridge, 1957;  
 Soda Lake, 1951; and Two Tips, 1957

- magnetotelluric station
- deep tests
- 8 — 8 contour lines showing values in ohm-meters
- ⊖ enclosed low

MAGNETOTELLURIC SLICE MAP AT A DEPTH OF 4000 FEET  
 SHOWING MINIMUM APPARENT RESISTIVITIES

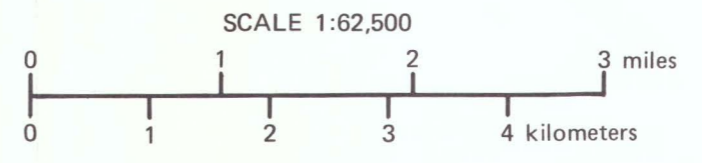

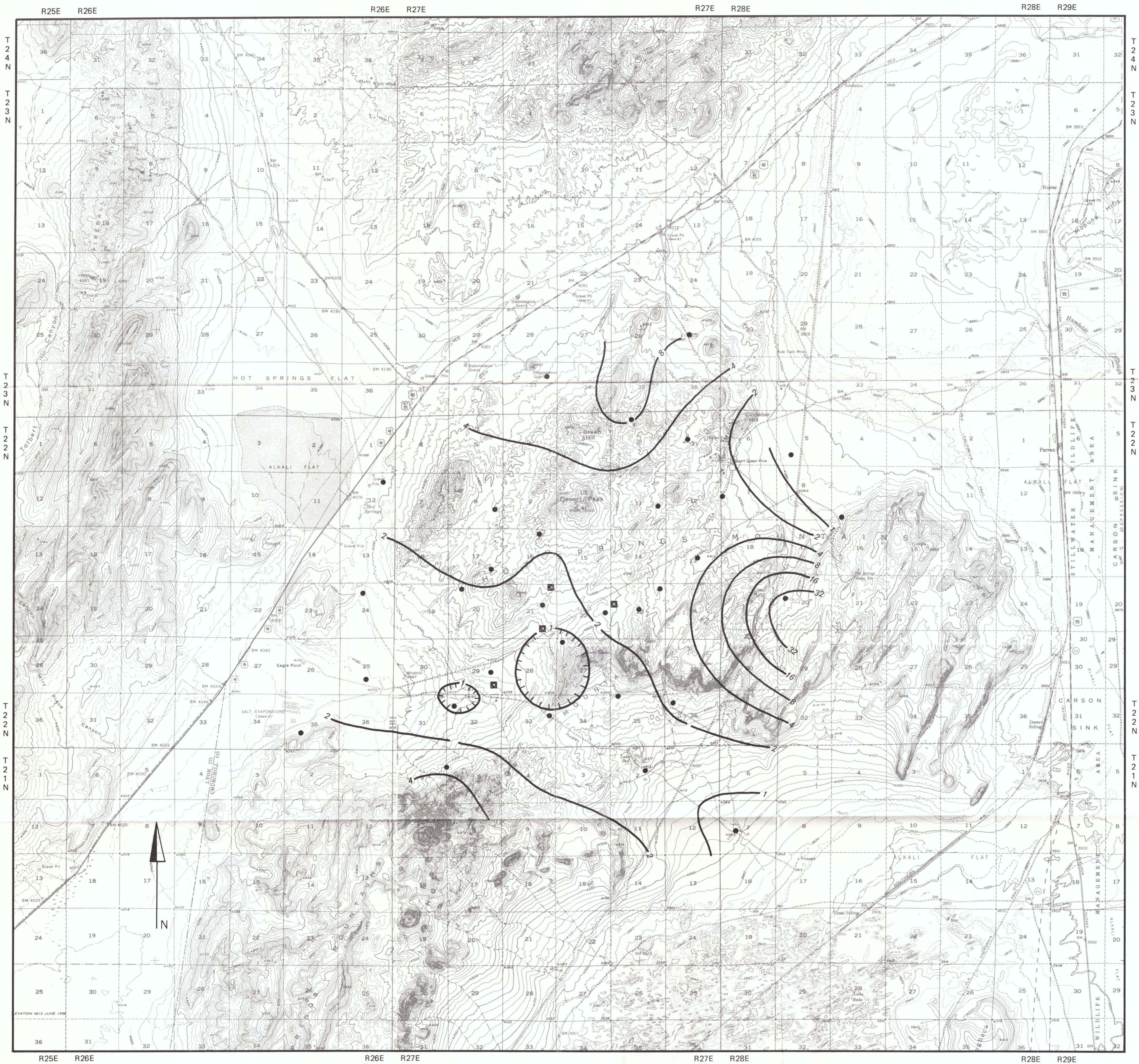

Base from U. S. Geological Survey 1:62,500:  
 Desert Peak, 1951; Fireball Ridge, 1957;  
 Soda lake, 1951; and Two Tips, 1957

- magnetotelluric station
- deep tests
- 2 — contour lines showing values in ohm-meters
- ⊖ enclosed low

MAGNETOTELLURIC SLICE MAP AT A DEPTH OF 1000 FEET  
 SHOWING MINIMUM APPARENT RESISTIVITIES



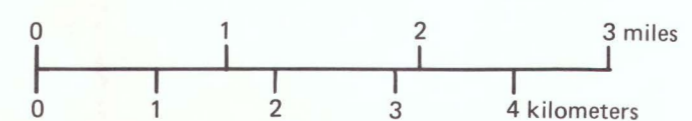

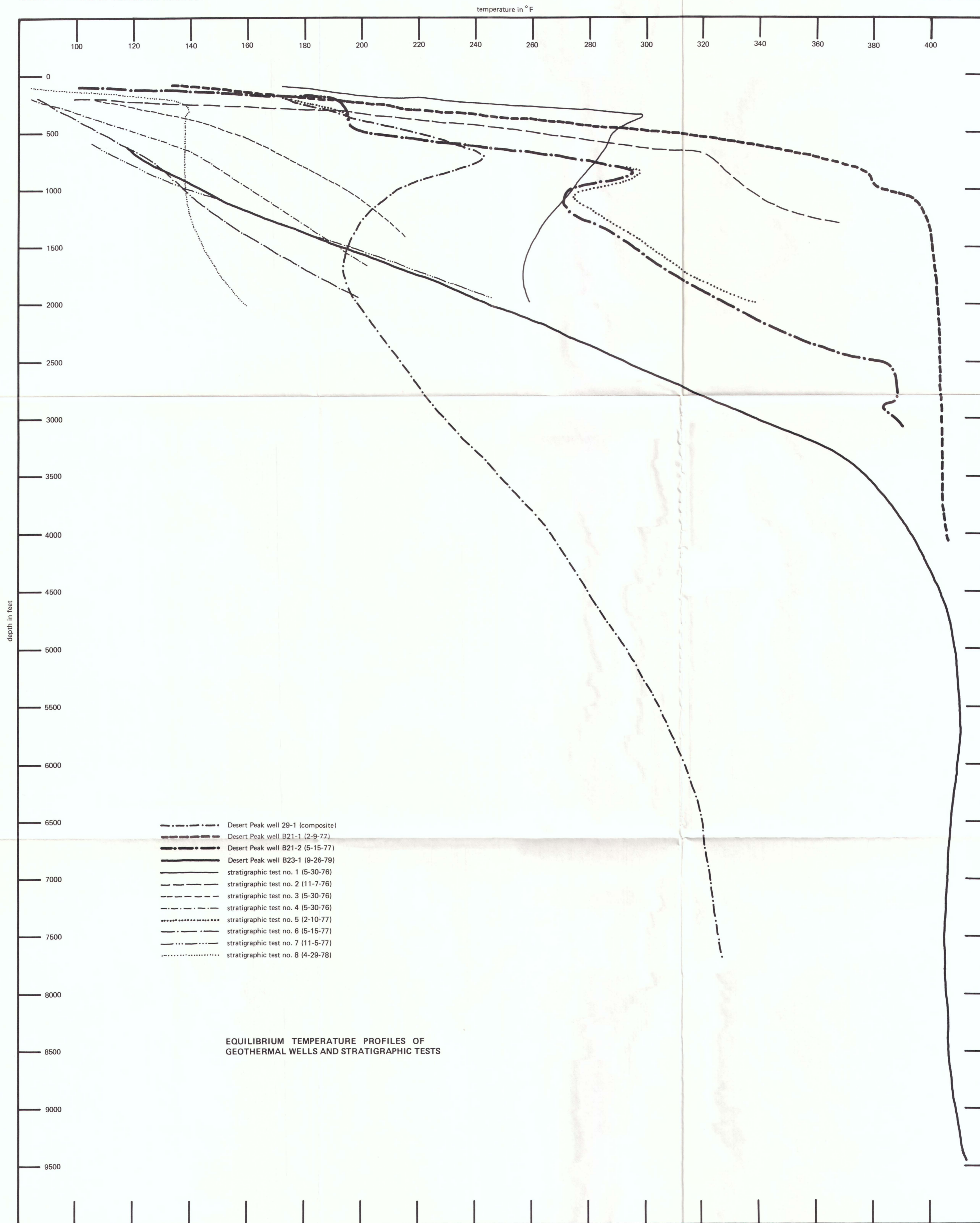
SCALE 1:62,500

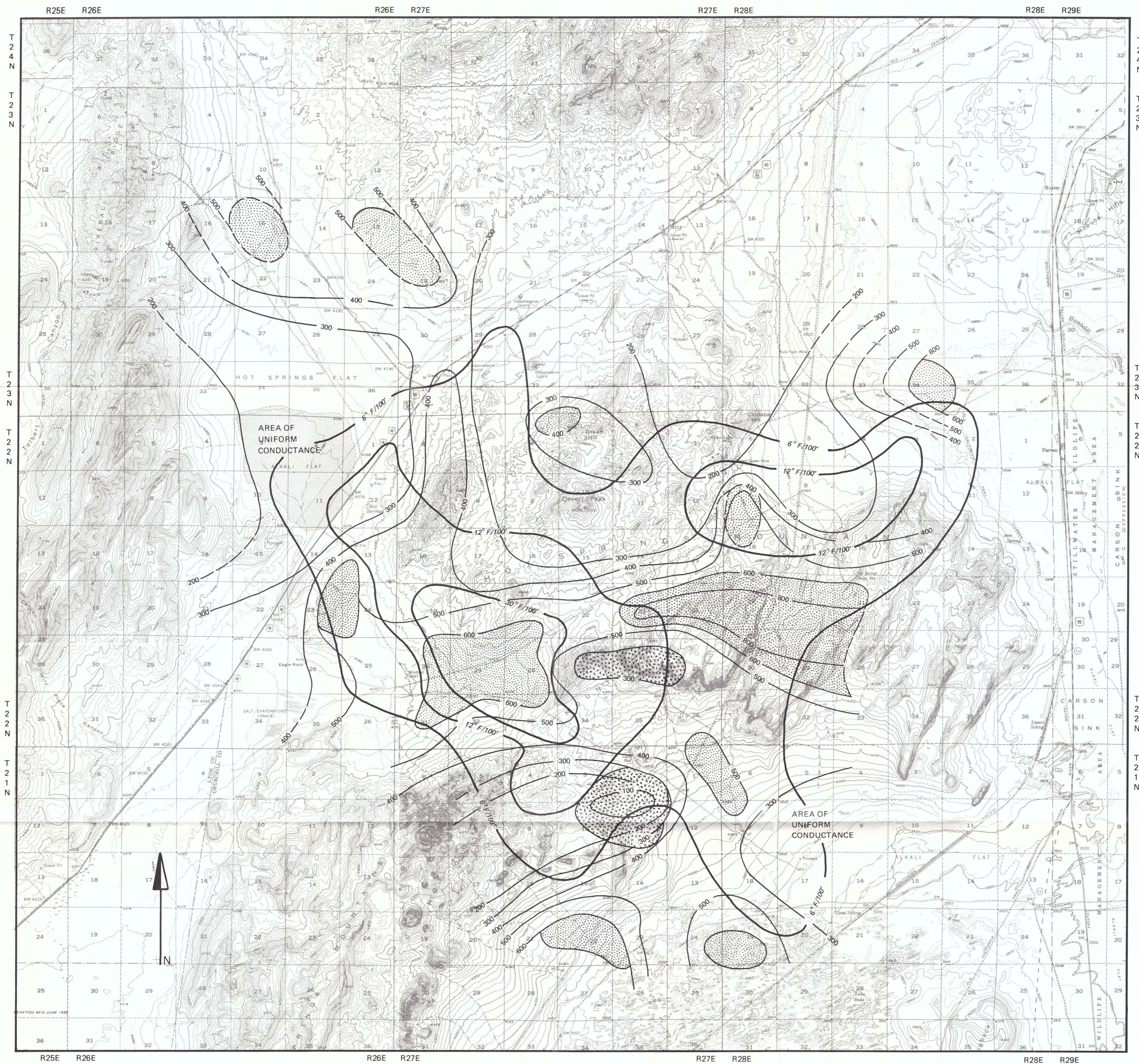





Base from U. S. Geological Survey 1:62,500:  
 Desert Peak, 1951; Fireball Ridge, 1957;  
 Soda Lake, 1951; and Two Tips, 1957.  
 Electrical data from Pritchard and Meidav (1974)

-  temperature-gradient contours
-  conductance in mhos, dashed where inferred
-  high conductivity regions
-  high resistivity blocks



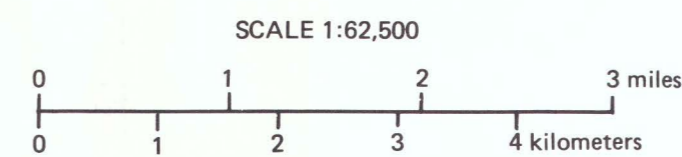

TOTAL FIELD APPARENT CONDUCTANCE MAP WITH  
 SELECTED TEMPERATURE - GRADIENT CONTOURS

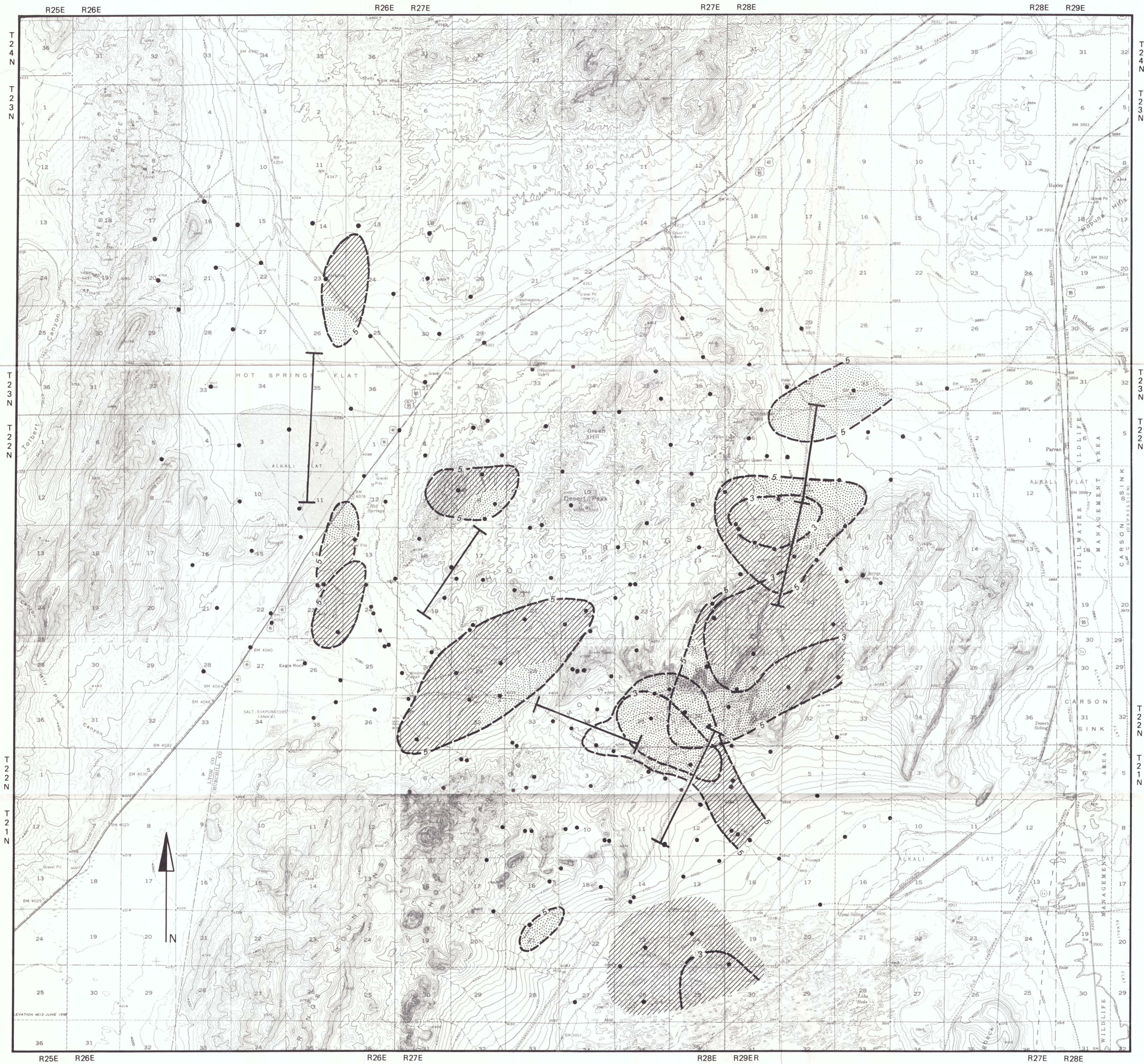



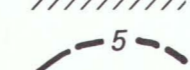

Base from U. S. Geological Survey 1:62,500:  
 Desert Peak, 1951; Fireball Ridge, 1957;  
 Soda Lake, 1951; and Two Tips, 1957  
 Electrical data from Pritchard and Meidav (1974)

-  dipole source location
-  receiver location
-  low resistivity regions detected
-  low resistivity regions extending relatively deep, probably greater than 5000 feet
-  outline of resistivity, values are in ohm-meters

ROVING DIPOLE APPARENT RESISTIVITY ANOMALY MAP

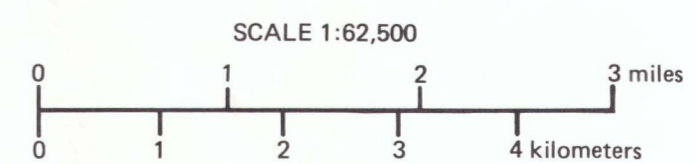

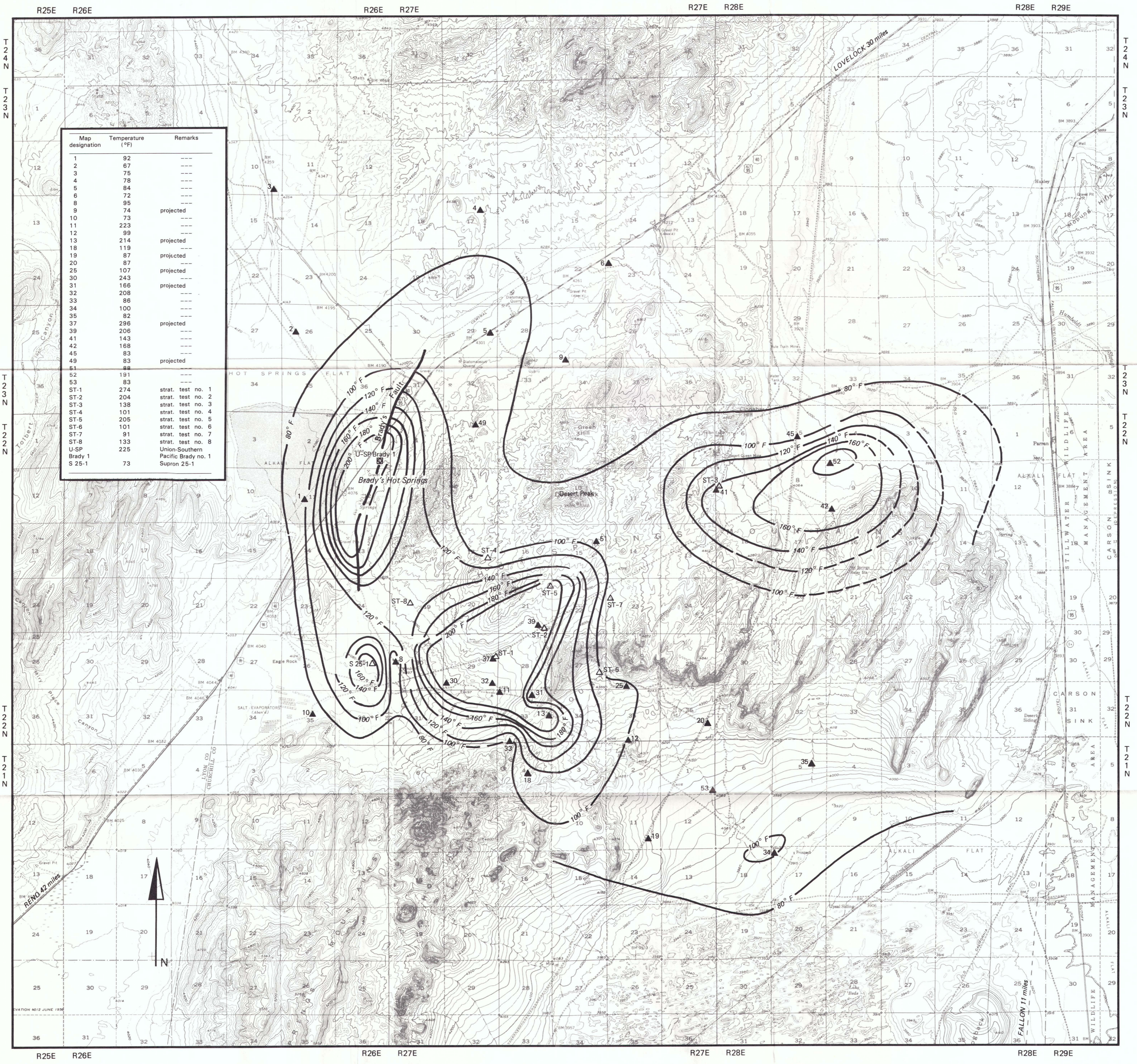

Map designation	Temperature (°F)	Remarks
1	92	---
2	67	---
3	76	---
4	78	---
5	84	---
6	72	---
8	95	---
9	74	projected
10	73	---
11	223	---
12	99	---
13	214	projected
18	119	---
19	87	projected
20	87	---
25	107	projected
30	243	---
31	166	projected
32	208	---
33	86	---
34	100	---
35	82	projected
37	296	---
39	206	---
41	143	---
42	168	---
45	83	---
49	83	projected
61	88	---
52	191	---
53	83	---
ST-1	274	strat. test no. 1
ST-2	204	strat. test no. 2
ST-3	138	strat. test no. 3
ST-4	101	strat. test no. 4
ST-5	205	strat. test no. 5
ST-6	101	strat. test no. 6
ST-7	91	strat. test no. 7
ST-8	133	strat. test no. 8
U-SP	225	Union-Southern
Brady 1		Pacific Brady no. 1
S 25-1	73	Supron 25-1

Base from U. S. Geological Survey 1:62,500:  
Desert Peak, 1951; Fireball Ridge, 1957;  
Soda Lake, 1951; and Two Tips, 1957

- ☐ shut-in producer
- geothermal well
- △ stratigraphic test
- ▲ temperature-gradient hole
- contour line; dashed where inferred
- Brady's Fault

ISOTHERMAL MAP - 300-FOOT DEPTH

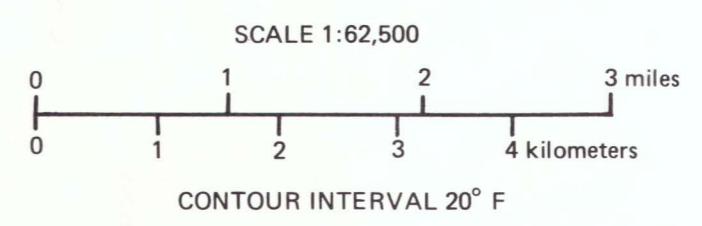

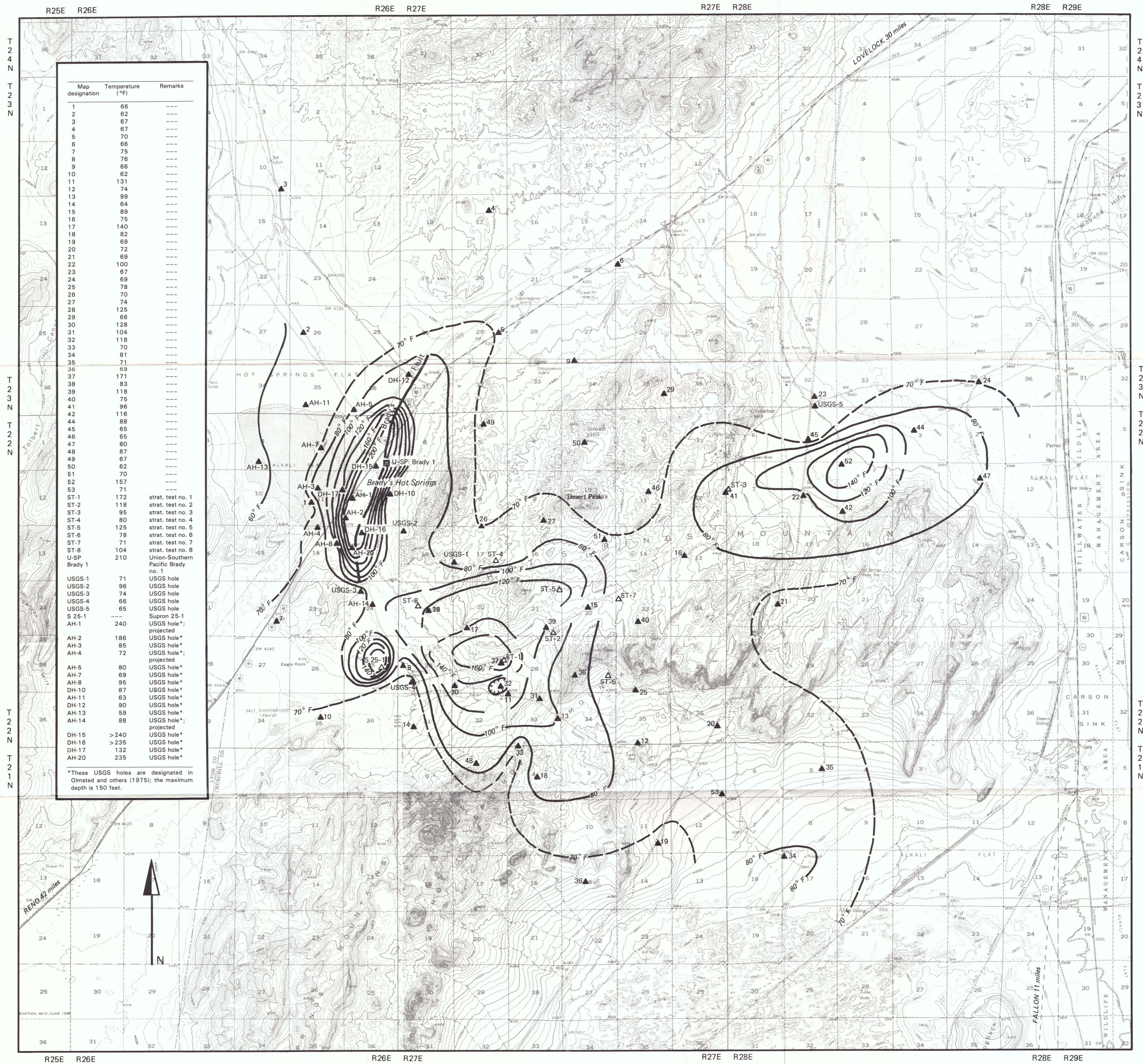

Map designation	Temperature (°F)	Remarks
1	66	---
2	62	---
3	67	---
4	67	---
5	70	---
6	66	---
7	75	---
8	76	---
9	66	---
10	62	---
11	131	---
12	74	---
13	99	---
14	64	---
15	89	---
16	75	---
17	140	---
18	82	---
19	69	---
20	72	---
21	69	---
22	100	---
23	67	---
24	69	---
25	78	---
26	70	---
27	74	---
28	125	---
29	66	---
30	128	---
31	104	---
32	118	---
33	70	---
34	81	---
35	71	---
36	69	---
37	171	---
38	83	---
39	118	---
40	75	---
41	96	---
42	116	---
44	88	---
45	65	---
46	65	---
47	80	---
48	87	---
49	67	---
50	62	---
51	70	---
52	157	---
53	71	---
ST-1	172	strat. test no. 1
ST-2	118	strat. test no. 2
ST-3	95	strat. test no. 3
ST-4	80	strat. test no. 4
ST-5	125	strat. test no. 5
ST-6	78	strat. test no. 6
ST-7	71	strat. test no. 7
ST-8	104	strat. test no. 8
U-SP	210	Union-Southern Pacific Brady 1
USGS-1	71	USGS hole no. 1
USGS-2	96	USGS hole
USGS-3	74	USGS hole
USGS-4	66	USGS hole
USGS-5	65	USGS hole
S 25-1	---	Supron 25-1
AH-1	240	USGS hole* projected
AH-2	186	USGS hole* projected
AH-3	85	USGS hole* projected
AH-4	72	USGS hole* projected
AH-5	80	USGS hole* projected
AH-7	69	USGS hole*
AH-8	95	USGS hole*
DH-10	87	USGS hole*
AH-11	63	USGS hole*
DH-12	90	USGS hole*
AH-13	59	USGS hole*
AH-14	88	USGS hole* projected
DH-15	>240	USGS hole*
DH-16	>235	USGS hole*
DH-17	132	USGS hole*
AH-20	235	USGS hole*

\*These USGS holes are designated in Olmsted and others (1975); the maximum depth is 150 feet.

Base from U. S. Geological Survey 1:62,500: Desert Peak, 1951; Fireball Ridge, 1957; Soda Lake, 1951; and Two Tips, 1957

- shut-in producer
- geothermal well
- ▲ stratigraphic test
- ▲ temperature-gradient hole
- enclosed low
- contour line; 70° F contour dashed
- Brady's Fault

ISOTHERMAL MAP - 100-FOOT DEPTH

SCALE 1:62,500

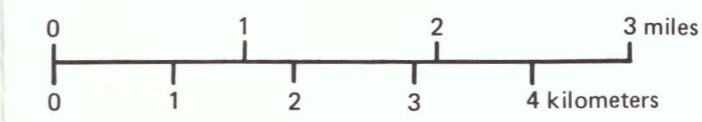

CONTOUR INTERVAL 20° F

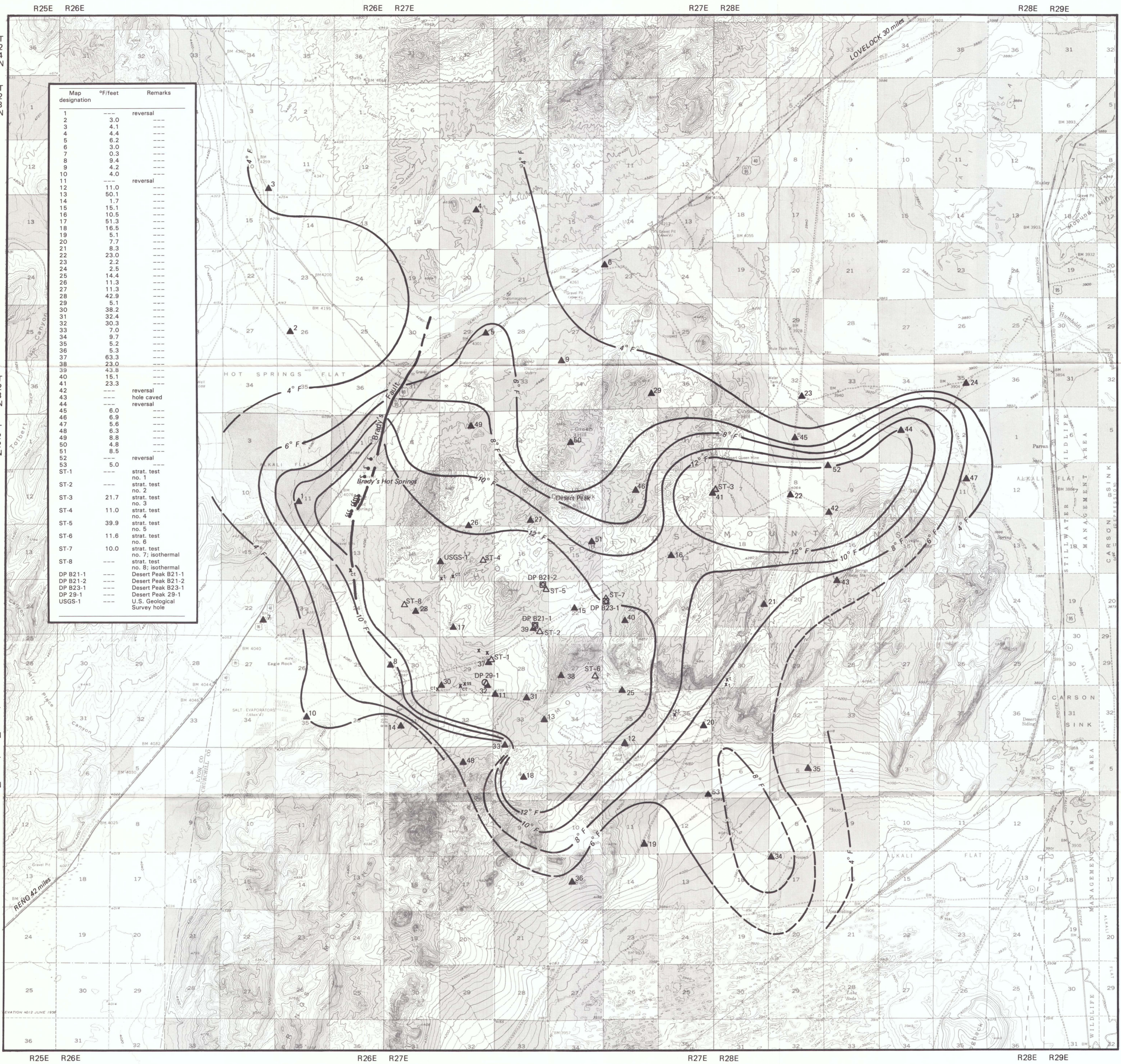

Map designation	°F/feet	Remarks
1	---	reversal
2	3.0	---
3	4.1	---
4	4.4	---
5	6.2	---
6	3.0	---
7	0.3	---
8	9.4	---
9	4.2	---
10	4.0	---
11	---	reversal
12	11.0	---
13	50.1	---
14	1.7	---
15	15.1	---
16	10.5	---
17	51.3	---
18	16.5	---
19	5.1	---
20	7.7	---
21	8.3	---
22	23.0	---
23	2.2	---
24	2.5	---
25	14.4	---
26	11.3	---
27	11.3	---
28	42.9	---
29	5.1	---
30	38.2	---
31	32.4	---
32	30.3	---
33	7.0	---
34	9.7	---
35	5.2	---
36	5.3	---
37	63.3	---
38	23.0	---
39	43.8	---
40	15.1	---
41	23.3	---
42	---	reversal
43	---	reversal hole caved
44	---	reversal
45	6.0	---
46	6.9	---
47	5.6	---
48	6.3	---
49	8.8	---
50	4.8	---
51	8.5	---
52	---	reversal
53	5.0	---
ST-1	---	strat. test no. 1
ST-2	---	strat. test no. 2
ST-3	21.7	strat. test no. 3
ST-4	11.0	strat. test no. 4
ST-5	39.9	strat. test no. 5
ST-6	11.6	strat. test no. 6
ST-7	10.0	strat. test no. 7; isothermal
ST-8	---	strat. test no. 8; isothermal
DP B21-1	---	Desert Peak B21-1
DP B21-2	---	Desert Peak B21-2
DP B23-1	---	Desert Peak B23-1
DP 29-1	---	Desert Peak 29-1
USGS-1	---	U.S. Geological Survey hole

Base from U. S. Geological Survey 1:62,500: Desert Peak, 1951; Fireball Ridge, 1957; Soda Lake, 1951; and Two Tips, 1957

temperature gradients shown are calculated on the difference in temperature between 100 feet of depth and the bottom of the drill hole

- ☒ shut-in producer
- geothermal well
- ⊙ non-commercial producer
- △ stratigraphic test
- ▲ temperature-gradient hole
- thermal spring
- x extinct thermal spring
- ct calcareous tufa
- ss siliceous sinter
- t travertine
- contour line, dashed where inferred
- Brady's Fault
- Southern Pacific Land Company

**SHALLOW TEMPERATURE-GRADIENT MAP**

SCALE 1:62,500

0 1 2 3 miles

0 1 2 3 4 kilometers

CONTOUR INTERVAL 2° F/100 FEET